

Using ADOBE® ILLUSTRATOR® CS5



© 2010 Adobe Systems Incorporated and its licensors. All rights reserved.

Using Adobe® Illustrator® CS5

This user guide is protected under copyright law, furnished for informational use only, is subject to change without notice, and should not be construed as a commitment by Adobe Systems Incorporated. Adobe Systems Incorporated assumes no responsibility or liability for any errors or inaccuracies that may appear in the informational content contained in this guide.

This user guide is licensed for use under the terms of the Creative Commons Attribution Non-Commercial 3.0 License. This License allows users to copy, distribute, and transmit the user guide for noncommercial purposes only so long as (1) proper attribution to Adobe is given as the owner of the user guide; and (2) any reuse or distribution of the user guide contains a notice that use of the user guide is governed by these terms. The best way to provide notice is to include the following link. To view a copy of this license, visit <http://creativecommons.org/licenses/by-nc-sa/3.0/>

Adobe, the Adobe logo, Adobe Garamond, Acrobat, ActionScript, After Effects, Caflisch Script, Creative Suite, Dreamweaver, Fireworks, Flash, Flash Catalyst, Flex, Illustrator, InCopy, InDesign, Kuler, PostScript, Photoshop, and Reader are either registered trademarks or trademarks of Adobe Systems Incorporated in the United States and/or other countries.

OpenType, Windows, and Windows Vista are registered trademarks of Microsoft Corporation in the U.S and/or other countries. Macintosh and Mac OS are trademarks of Apple Inc., registered in the United States and other countries. Symbian and all Symbian based marks and logos are trademarks of Symbian Limited. SVG is a trademark of the World Wide Web Consortium; marks of the W3C are registered and held by its host institutions MIT, INRIA and Keio. Certain trademarks are owned by The Proximity Division of Franklin Electronic Publishers, Inc., and are used by permission. Merriam-Webster is a trademark of Merriam-Webster, Inc. All other trademarks are the property of their respective owners.

Updated Information/Additional Third Party Code Information available at <http://www.adobe.com/go/thirdparty>.

Portions include software under the following terms:

This product contains either BSAFE and/or TIPEM software by RSA Data Security, Inc.

This software is based in part on the work of the Independent JPEG Group.

This product includes software developed by the Apache Software Foundation (<http://www.apache.org>)

This Program was written with MacApp®: ©1985-1988 Apple Computer, Inc. APPLE COMPUTER, INC. MAKES NO WARRANTIES WHATSOEVER, EITHER EXPRESS OR IMPLIED, REGARDING THIS PRODUCT, INCLUDING WARRANTIES WITH RESPECT TO ITS MERCHANTABILITY OR ITS FITNESS FOR ANY PARTICULAR PURPOSE. The MacApp software is proprietary to Apple Computer, Inc. and is licensed to Adobe for distribution only for use in combination with Adobe Illustrator.

PANTONE® colors displayed here may not match PANTONE-identified standards. Consult current PANTONE Color Publications for accurate color. PANTONE® and other Pantone, Inc. trademarks are the property of Pantone, Inc. © Pantone, Inc., 2010.

This product includes software developed by Focoltone Colour System.

Copyright © 1994 Hewlett-Packard Company Copyright © 1996, 1997 Silicon Graphics Computer Systems, Inc.

Software is produced under DIC's copyrights of color-data-base derived from Sample Books.

Flash 10 video compression and decompression is powered by On2 TrueMotion video technology. ©1992-2005 On2 Technologies, Inc. All Rights Reserved. <http://www.on2.com>

This product includes software developed by the OpenSymphony Group (<http://www.opensymphony.com/>)

Portions of this code are licensed from Nellymoser (www.nellymoser.com)

**Sorenson
Spark.**

Sorenson Spark™ video compression and decompression technology licensed from Sorenson Media, Inc.

MPEG Layer-3 audio coding technology licensed from Fraunhofer IIS and Thomson. mp3 Surround audio coding technology licensed from Fraunhofer IIS, Agere Systems and Thomson. mp3PRO audio coding technologies licensed from Coding Technologies, Fraunhofer IIS and Thomson Multimedia. (<http://www.iis.fhg.de/amm/>).

Certain Spelling portions of this product is based on Proximity Linguistic Technology. ©1990 Merriam-Webster Inc. ©1990 All rights reserved. Proximity Technology A Division of Franklin Electronic Publishers, Inc. Burlington, New Jersey USA. ©2003 Franklin Electronic Publishers Inc. ©2003 All rights reserved. Proximity Technology A Division of Franklin Electronic Publishers, Inc. Burlington, New Jersey USA. Legal Supplement ©1990/1994 Merriam-Webster Inc./Franklin Electronic Publishers Inc. ©1994 All rights reserved. Proximity Technology A Division of Franklin Electronic Publishers, Inc. Burlington, New Jersey USA. ©1990/1994 Merriam-Webster Inc./Franklin Electronic Publishers Inc. ©1997 All rights reserved. Proximity Technology A Division of Franklin Electronic Publishers, Inc. Burlington, New Jersey USA ©1990 Merriam-Webster Inc. ©1993 All rights reserved. Proximity Technology A Division of Franklin Electronic Publishers, Inc. Burlington, New Jersey USA. ©2004 Franklin Electronic Publishers Inc. ©2004 All rights reserved. Proximity Technology A Division of Franklin Electronic Publishers, Inc. Burlington, New Jersey USA. ©1991 Dr. Lluís de Yzaguirre I Maura ©1991 All rights reserved. Proximity Technology A Division of Franklin Electronic Publishers, Inc. Burlington, New Jersey USA. ©1990 Munksgaard International Publishers Ltd. ©1990 All rights reserved. Proximity Technology A Division of Franklin Electronic Publishers, Inc. Burlington, New Jersey USA. ©1990 Van Dale Lexicografie bv ©1990 All rights reserved. Proximity Technology A Division of Franklin Electronic Publishers, Inc. Burlington, New Jersey USA. ©1995 Van Dale Lexicografie bv ©1996 All rights reserved. Proximity Technology A Division of Franklin Electronic Publishers, Inc. Burlington, New Jersey USA. ©1990 IDE a.s. ©1990 All rights reserved. Proximity Technology A Division of Franklin Electronic Publishers, Inc. Burlington, New Jersey USA. ©1992 Hachette/Franklin Electronic Publishers Inc. ©2004 All rights reserved. Proximity Technology A Division of Franklin Electronic Publishers, Inc. Burlington, New Jersey USA. ©1991 Text & Satz Datentechnik ©1991 All rights reserved. Proximity Technology A Division of Franklin Electronic Publishers, Inc. Burlington, New Jersey USA. ©2004 Bertelsmann Lexikon Verlag ©2004 All rights reserved. Proximity Technology A Division of Franklin Electronic Publishers, Inc. Burlington, New Jersey USA. ©2004 MorphoLogic Inc. ©2004 All rights reserved. Proximity Technology A Division of Franklin Electronic Publishers, Inc. Burlington, New Jersey USA. ©1990 William Collins Sons & Co. Ltd. ©1990 All rights reserved. Proximity Technology A Division of Franklin Electronic Publishers, Inc. Burlington, New Jersey USA. ©1993-95 Russicon Company Ltd. ©1995 All rights reserved. Proximity Technology A Division of Franklin Electronic Publishers, Inc. Burlington, New Jersey USA. ©2004 IDE a.s. ©2004 All rights reserved. Proximity Technology A Division of Franklin Electronic Publishers, Inc. Burlington, New Jersey USA. The Hyphenation portion of this product is based on Proximity Linguistic Technology. ©2003 Franklin Electronic Publishers Inc. ©2003 All rights reserved. Proximity Technology A Division of Franklin Electronic Publishers, Inc. Burlington, New Jersey USA. ©1984 William Collins Sons & Co. Ltd. ©1988 All rights reserved. Proximity Technology A Division of Franklin Electronic Publishers, Inc. Burlington, New Jersey USA. ©1990 Munksgaard International

Publishers Ltd. ©1990 All rights reserved. Proximity Technology A Division of Franklin Electronic Publishers, Inc. Burlington, New Jersey USA. ©1997 Van Dale Lexicografie bv ©1997 All rights reserved. Proximity Technology A Division of Franklin Electronic Publishers, Inc. Burlington, New Jersey USA. ©1984 Editions Fernand Nathan ©1989 All rights reserved. Proximity Technology A Division of Franklin Electronic Publishers, Inc. Burlington, New Jersey USA. ©1983 S Fischer Verlag ©1997 All rights reserved. Proximity Technology A Division of Franklin Electronic Publishers, Inc. Burlington, New Jersey USA. ©1989 Zanichelli ©1989 All rights reserved. Proximity Technology A Division of Franklin Electronic Publishers, Inc. Burlington, New Jersey USA. ©1989 IDE a.s. ©1989 All rights reserved. Proximity Technology A Division of Franklin Electronic Publishers, Inc. Burlington, New Jersey USA. ©1990 Espasa-Calpe ©1990 All rights reserved. Proximity Technology A Division of Franklin Electronic Publishers, Inc. Burlington, New Jersey USA. ©1989 C.A. Stromberg AB. ©1989 All rights reserved. Proximity Technology A Division of Franklin Electronic Publishers, Inc. Burlington, New Jersey USA.

Adobe Systems Incorporated, 345 Park Avenue, San Jose, California 95110, USA.

Notice to U.S. Government End Users: The Software and Documentation are "Commercial Items," as that term is defined at 48 C.F.R. §2.101, consisting of "Commercial Computer Software" and "Commercial Computer Software Documentation," as such terms are used in 48 C.F.R. §12.212 or 48 C.F.R. §227.7202, as applicable. Consistent with 48 C.F.R. §12.212 or 48 C.F.R. §§227.7202-1 through 227.7202-4, as applicable, the Commercial Computer Software and Commercial Computer Software Documentation are being licensed to U.S. Government end users (a) only as Commercial Items and (b) with only those rights as are granted to all other end users pursuant to the terms and conditions herein. Unpublished-rights reserved under the copyright laws of the United States. Adobe agrees to comply with all applicable equal opportunity laws including, if appropriate, the provisions of Executive Order 11246, as amended, Section 402 of the Vietnam Era Veterans Readjustment Assistance Act of 1974 (38 USC 4212), and Section 503 of the Rehabilitation Act of 1973, as amended, and the regulations at 41 CFR Parts 60-1 through 60-60, 60-250, and 60-741. The affirmative action clause and regulations contained in the preceding sentence shall be incorporated by reference.

Contents

Chapter 1: What's New

Perspective drawing	1
Beautiful strokes	1
Bristle brush	2
Crisp graphics for web and mobile devices	2
Multiple artboards enhancements	2
Shape Builder tool	3
Drawing enhancements	3
Roundtrip editing with Adobe Flash Catalyst CS5	4
Resolution Independent Effects	4

Chapter 2: Workspace

Workspace basics	5
Customizing the workspace	9
Tools	15
Tool galleries	18
Files and templates	25
Working with ConnectNow	30
Using multiple artboards	31
Viewing artwork	37
Rulers, grids, guides, and crop marks	42
Setting preferences	47
Recovery, undo, and automation	49

Chapter 3: Drawing

Drawing basics	50
Drawing simple lines and shapes	54
Drawing pixel-aligned paths for web workflows	58
Drawing with the Pencil tool	61
Drawing with the Pen tool	63
Editing paths	68
Perspective drawing	78
Tracing artwork with Live Trace	94
Manually trace artwork using template layers	98
Symbols	99
Symbolism tools and symbol sets	105
Drawing flares	110

Chapter 4: Color

About color	113
Selecting colors	118
Using and creating swatches	122
Working with color groups (harmonies)	128

Kuler panel	143
Adjusting colors	144
Chapter 5: Painting	
About painting	149
Painting with fills and strokes	149
Live Paint groups	160
Brushes	168
Transparency and blending modes	180
Gradients	188
Meshes	192
Patterns	195
Chapter 6: Selecting and arranging objects	
Selecting objects	201
Grouping and expanding objects	210
Moving, aligning, and distributing objects	211
Rotating and reflecting objects	216
Using layers	220
Locking, hiding, and deleting objects	224
Stacking objects	225
Duplicating objects	227
Chapter 7: Reshaping objects	
Transforming objects	230
Scaling, shearing, and distorting objects	232
Reshape using envelopes	237
Combining objects	239
Cutting and dividing objects	246
Clipping masks	247
Blending objects	250
Reshaping objects with effects	254
Building new shapes using the Shape Builder tool	255
Creating 3D objects	258
Chapter 8: Importing, exporting, and saving	
Importing files	267
Importing bitmap images	271
Importing Adobe PDF files	273
Importing EPS, DCS, and AutoCAD files	274
Importing artwork from Photoshop	276
Saving artwork	277
Exporting artwork	283
Creating Adobe PDF files	290
Adobe PDF options	294
File information and metadata	301

Chapter 9: Type

About type 304

Importing text 304

Creating text 305

Creating type on a path 312

Scaling and rotating type 316

Spelling and language dictionaries 317

Fonts 319

Formatting type 321

Line and character spacing 330

Special characters 332

Formatting paragraphs 335

Hyphenation and line breaks 339

Tabs 341

Character and paragraph styles 344

Exporting text 346

Formatting Asian characters 348

Creating composite fonts 357

Updating text from Illustrator 10 360

Chapter 10: Creating special effects

Appearance attributes 362

Working with effects 367

Summary of effects 370

Drop shadows, glows, and feathering 377

Creating sketches and mosaics 378

Graphic styles 380

Chapter 11: Web graphics

Best practices for creating web graphics 385

Slices and image maps 388

SVG 392

Creating animations 395

Chapter 12: Working with FXG

About FXG 399

Best practices for using FXG 399

Save an Illustrator file in FXG format 400

Illustrator and Flash Catalyst workflow 402

FXG mapping of Illustrator objects and attributes 403

Chapter 13: Printing

Setting up documents for printing 414

Printing color separations 419

Printer's marks and bleed 422

PostScript printing 424

Printing with color management 427

Printing gradients, meshes, and color blends 428

Printing and saving transparent artwork	431
Overprinting	438
Trapping	440
Print presets	444
Chapter 14: Automating tasks	
Actions	447
Scripts	454
Data-driven graphics	455
Chapter 15: Graphs	
Creating graphs	460
Formatting graphs	464
Adding pictures and symbols to graphs	468
Chapter 16: Keyboard shortcuts	
Customizing keyboard shortcuts	473
Default keyboard shortcuts	474

Chapter 1: What's New

Adobe Illustrator CS5 provides precision and power with sophisticated drawing tools, expressive lifelike brushes, a host of time-savers, and integration with Adobe CS Live online services.

Perspective drawing, a Bristle brush, variable width strokes, and the Shape Builder tool are among the new features in Illustrator's vector-graphics environment.

With enhanced integration among Adobe products, you can easily move between Illustrator CS5 and products such as Adobe Flash® Catalyst™ CS5 where you can add interaction to your designs.

Perspective drawing

The new Perspective Grid tool allows you to turn on a grid that supports drawing directly on planes of true perspective. Use the perspective grid to draw shapes and scenes in accurate 1, 2, or 3-point perspectives. The new Perspective Selection tool allows you to move, scale, duplicate, and transform objects dynamically. You can also move objects perpendicular to its current location using the Perspective Selection tool.

Imagine being able to easily add a series of street lamps to a city scape for a sequential lighting animation, or fence posts to a reference landscape scene to complete your billboard for a western wilderness outpost. With the Perspective Grid tool group, you quickly and easily work in a preset perspective. The perspective grid provides grid presets to manage the viewing angle and viewing distance for the scene along with widgets to control vanishing points, horizon height, ground level, and the origin. You can also use the perspective grid to draw vector objects on top of a reference photograph or video still placed on your artboard.

See [“Perspective drawing”](#) on page 78.

Beautiful strokes

Illustrator CS5 provides several new features that enhance the capability to design with strokes.

Variable-width strokes

Use the Width tool to draw strokes with variable widths that you can quickly and smoothly adjust at any point, symmetrically or along either side. You can also create and save custom width profiles, which you can reapply to any stroke.

See [“Create strokes with variable widths”](#) on page 158.

Dashed line adjustments

New options in the Stroke panel allow you to control the alignment of dashes. You can choose to align dashed strokes symmetrically around corners and at the end of open paths or preserve the dash and gaps in strokes.

See [“Create dotted or dashed lines”](#) on page 153.

Precise arrowheads

You can now select and define arrowheads using the Stroke panel. You can also choose to lock the tip or base of the arrowhead to the path endpoint.

See [“Add arrowheads”](#) on page 154, [“Customize arrowheads”](#) on page 154.

Stretch control for brushes

Define the scaling for art and pattern brushes along a path. Choose areas of the brush stroke to be resized in proportion. For example, you can elongate the middle of a banner, while keeping the detailed, curly ends from stretching.

Brushes with corner control

Apply art and pattern brushes to a path and get clean results, even at tight bends or corners. Where strokes of different widths join, or they form obtuse or acute angles, choose options to properly fill points where joins occur.

Bristle brush

With the Bristle brush, paint with vectors that resemble real world brush strokes. You can draw and render artwork just the way you use a natural media such as watercolors and oils, with the scalability and editability of vectors. The Bristle brush also provides breakthrough control of painting. You can set bristle characteristics, such as size, length, thickness, and stiffness, in addition to setting bristle density, brush shape, and paint opacity.

To explore more capabilities of the Bristle brush, use it with the tablet and 6D pen (Wacom Art Pen). The 6D pen automatically responds to pressure, bearing, and tilt with 360-degree barrel rotation and also provides an accurate brush preview.

See [“Bristle brush”](#) on page 177.

Crisp graphics for web and mobile devices

Create vector objects precisely on the pixel grid for pixel-aligned artwork. It is critical that raster images look sharp, especially standard web graphics at 72-ppi resolution, when designing artwork for Adobe Flash Catalyst, Adobe Flash Professional software, and Adobe Dreamweaver. Pixel alignment is also useful for video resolution rasterization control. In Illustrator CS5, new web graphics tools include type enhancements. Choose one of four text anti-aliasing options for each of your Illustrator text frames.

See [“Drawing pixel-aligned paths for web workflows”](#) on page 58.

Multiple artboards enhancements

The multiple artboards functionality has been enhanced significantly in Illustrator CS5. Some of the new features include a new Artboards panel, which allows you to add artboards, reorder artboards in the Artboards panel, rearrange artboards, and create duplicate artboards.

Specify custom names for your artboards using the Control panel and the Artboards panel. You can paste objects at a particular location on the artboard and paste artwork on all artboards at the same location using the new Paste in Place and Paste on All Artboards options. You can also set the option to automatically rotate artboards for printing.

See [“Using multiple artboards”](#) on page 31.

Shape Builder tool

The Shape Builder tool is an interactive tool for creating complex shapes by merging and erasing simpler shapes. It works on simple and compound paths and intuitively highlights edges and regions of the selected art, which can be merged to form new shapes. For example, you can draw a stroke across the middle of a circle and quickly create two half-circles without opening any panel or choosing another tool. The Shape Builder tool can also break overlapping shapes to create distinct objects and easily adopts art styles when objects are merged. You can also enable the Color Swatch cursor to select colors for your artwork.

See [“Building new shapes using the Shape Builder tool”](#) on page 255.

Drawing enhancements

Symbol enhancements

Illustrator CS5 provides enhanced 9-slice scaling support. You can now directly use 9-slice scaling on symbols in Illustrator, which makes it easier to work with web elements such as rounded rectangle.

See [“Symbol registration point”](#) on page 100, [“Use 9-slice scaling”](#) on page 101, [“Add sublayers for symbols”](#) on page 101, [“Reset transformations”](#) on page 104.

Artboard ruler origin and coordinates enhancement

Artboard ruler origin and coordinates are now oriented from the upper left. Scripts that use a previous coordinate system also work correctly with this enhancement. You can also choose to work with a global ruler that provides coordinates across all your artboards, or work with local, artboard-specific rulers.

See [“Use rulers”](#) on page 42.

Path join enhancement

Join open paths in a single keystroke with objects selected. You can also choose to join open paths using corner joins or smooth joins.

See [“Join two or more paths”](#) on page 71.

Select behind capability

Use a keyboard shortcut to easily select an individual object located behind other objects.

See [“Select behind objects”](#) on page 204.

Draw behind and draw inside modes

Draw behind other objects without choosing layers or setting the stacking order. Draw or place an image inside a shape, including live text. The draw inside mode automatically creates a clipping mask from the selected object.

See “[Draw Behind mode](#)” on page 54, “[Draw Inside mode](#)” on page 54.

Roundtrip editing with Adobe Flash Catalyst CS5

Use Illustrator CS5 for interaction design, now enabled by new Adobe Flash Catalyst CS5, available with all the Adobe CS5 products. Develop your ideas and design your interface in Illustrator, creating screen layouts and individual elements such as logos and button graphics. Then open your artwork in Flash Catalyst and add actions and interactive components, without writing code. After adding interactivity to your designs, you can make edits and design changes directly in Illustrator. For example, you can edit the look of interactive button states in Illustrator while ensuring that the structure you added in Flash Catalyst is maintained.

See “[Working with FXG](#)” on page 399.

Resolution Independent Effects

With Resolution Independent Effects, raster effects such as Blur and Texture can maintain a consistent appearance across media.

You can create artwork for different types of output while maintaining the ideal appearance for raster effects. This is irrespective of any change in resolution setting from print to web to video. You can also increase the resolution and still maintain the appearance of raster effects. For low-resolution artwork, you can scale up the resolution for high-quality printing.

See “[About raster effects](#)” on page 368.

Chapter 2: Workspace

Workspace basics

To see a video on using Adobe Illustrator, see www.adobe.com/go/lrvid5207_ai.

Workspace overview

You create and manipulate your documents and files using various elements, such as panels, bars, and windows. Any arrangement of these elements is called a *workspace*. The workspaces of the different applications in Adobe® Creative Suite® 5 share the same appearance so that you can move between the applications easily. You can also adapt each application to the way you work by selecting from several preset workspaces or by creating one of your own.

Although the default workspace layout varies in different products, you manipulate the elements much the same way in all of them.

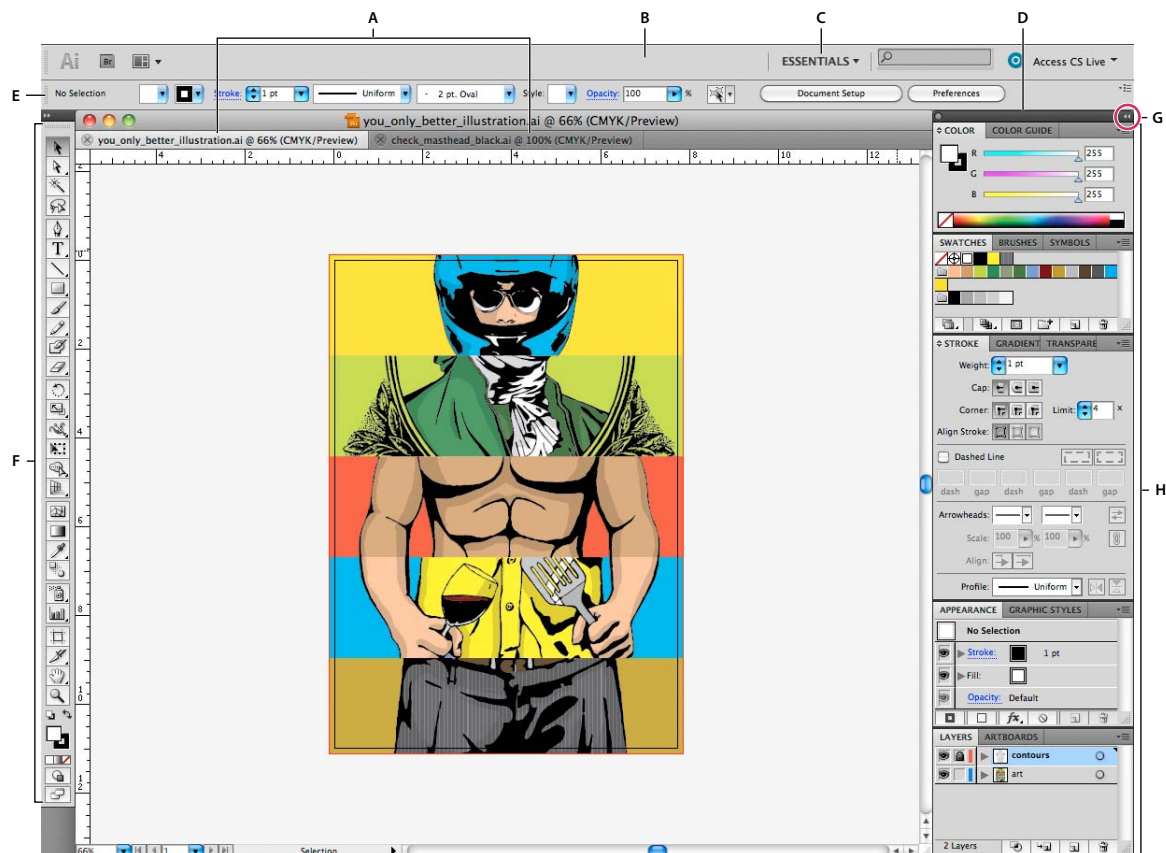

Default Illustrator workspace

A. Tabbed Document windows B. Application bar C. Workspace switcher D. Panel title bar E. Control panel F. Tools panel G. Collapse To Icons button H. Four panel groups in vertical dock

- The *Application bar* across the top contains a workspace switcher, menus (Windows only), and other application controls. On the Mac for certain products, you can show or hide it using the Window menu.

- The *Tools panel* contains tools for creating and editing images, artwork, page elements, and so on. Related tools are grouped.
- The *Control panel* displays options for the currently selected tool. In Illustrator, the Control panel displays options for the currently selected object. (In Adobe Photoshop® this is known as the Options bar. In Adobe Flash®, Adobe Dreamweaver®, and Adobe Fireworks® this is known as the Property Inspector and includes properties of the currently selected element.)
- The *Document window* displays the file you're working on. Document windows can be tabbed and, in certain cases, grouped and docked.
- *Panels* help you monitor and modify your work. Examples include the Timeline in Flash, the Brush panel in Illustrator, the Layers panel in Adobe Photoshop®, and the CSS Styles panel in Dreamweaver. Panels can be grouped, stacked, or docked.
- The *Application frame* groups all the workspace elements in a single, integrated window that lets you treat the application as a single unit. When you move or resize the Application frame or any of its elements, all the elements within it respond to each other so none overlap. Panels don't disappear when you switch applications or when you accidentally click out of the application. If you work with two or more applications, you can position each application side by side on the screen or on multiple monitors.

If you are using a Mac and prefer the traditional, free-form user interface, you can turn off the Application frame. In Adobe Illustrator®, for example, select Window > Application Frame to toggle it on or off. (In Flash, the Application frame is on permanently for Mac, and Dreamweaver for Mac does not use an Application frame.)

Hide or show all panels

- (Illustrator, Adobe InCopy®, Adobe InDesign®, Photoshop, Fireworks) To hide or show all panels, including the Tools panel and Control panel, press Tab.
- (Illustrator, InCopy, InDesign, Photoshop) To hide or show all panels except the Tools panel and Control panel, press Shift+Tab.

 You can temporarily display hidden panels if Auto-Show Hidden Panels is selected in Interface preferences. It's always on in Illustrator. Move the pointer to the edge of the application window (Windows®) or to the edge of the monitor (Mac OS®) and hover over the strip that appears.

- (Flash, Dreamweaver, Fireworks) To hide or show all panels, press F4.

Display panel options

- ❖ Click the panel menu icon  in the upper-right corner of the panel.

 You can open a panel menu even when the panel is minimized.

 In Photoshop, you can change the font size of the text in the Control panel, in the panels, and in tool tips. Choose a size from the UI Font Size menu in Interface preferences.

(Illustrator) Adjust panel brightness

- ❖ In User Interface preferences, move the Brightness slider. This control affects all panels, including the Control panel.

Reconfigure the Tools panel

You can display the tools in the Tools panel in a single column, or side by side in two columns. (This feature is not available in the Tools panel in Fireworks and Flash.)

 *In InDesign and InCopy, you also can switch from single-column to double-column (or single-row) display by setting an option in Interface preferences.*

- ❖ Click the double arrow at the top of the Tools panel.

Search For Help box

Use the Search For Help box on the right side of the Application bar to search for Help topics and online content. If you have an active Internet connection, you can access all content on the Community Help website. If you search for Help without an active Internet connection, search results are limited to Help content that is included with Illustrator.



- 1 In the search box, type the name of the item on which you want to search (such as a feature, application, or tool).
- 2 Press Enter.

All topics available from the Community Help center appear in a separate browser window.

About screen modes

You can change the visibility of the illustration window and menu bar using the mode options at the bottom of the Tools panel. To access panels when in Full Screen Mode, position the cursor at the left or right edge of the screen and the panels will pop up. If you've moved them from their default locations, you can access them from the Window menu.

You can choose one of the following modes:

- Normal Screen Mode  displays artwork in a standard window, with a menu bar at the top and scroll bars on the sides.
- Full Screen Mode With Menu Bar  displays artwork in a full-screen window, with a menu bar at the top and scroll bars.
- Full Screen Mode  displays artwork in a full-screen window, with no title bar or menu bar.

Using the status bar

The status bar appears at the lower-left edge of the illustration window. It displays any of the following:

- current zoom level
- current tool in use
- current artboard in use
- navigation controls for multiple artboards
- date and time
- number of undos and redos available
- document color profile
- status of a managed file

Click the status bar to do any of the following:

- Change the type of information displayed in the status bar by selecting an option from the Show submenu.
- Show the current file in Adobe Bridge by choosing Reveal In Bridge.

Enter values in panels and dialog boxes

You enter values using the same methods in all panels and dialog boxes. You can also perform simple math in any box that accepts numeric values. For example, if you want to move a selected object 3 units to the right using the current measurement units, you don't have to work out the new horizontal position—simply type **+3** after the current value in the Transform panel.

Enter a value in a panel or dialog box

- ❖ Do any of the following:
 - Type a value in the box, and press Enter or Return.
 - Drag the slider.
 - Drag the dial.
 - Click the arrow buttons in the panel to increase or decrease the value.
 - Click in the box and then use the Up Arrow key and Down Arrow key on the keyboard to increase or decrease the value. Hold down Shift and click an arrow key to magnify the increase rate or decrease rate.
 - Select a value from the menu associated with the box.

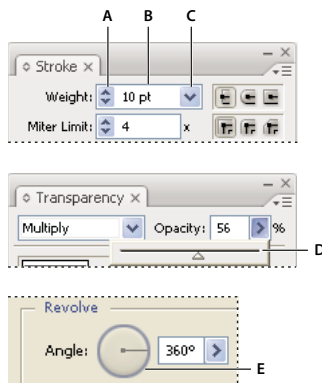

Ways to enter values

A. Arrow buttons B. Text box C. Menu arrow D. Slider E. Dial

Calculate values in a panel or dialog box

- 1 In a text box that accepts numerical values, do one of the following:
 - To replace the entire current value with a mathematical expression, select the entire current value.
 - To use the current value as part of a mathematical expression, click before or after the current value.
- 2 Type a simple mathematical expression using a single mathematical operator, such as + (plus), - (minus), x (multiplication), / (division), or % (percent).

For example, **0pt + 3** or **5mm + 4**. Similarly, **3cm * 50%** equals 3 centimeters multiplied by 50%, or 1.50 cm, and **50pt + 25%** equals 50 points plus 25% of 50 points, or 62.5 points.

- 3 Press Enter or Return to apply the calculation.

Control panel overview

The Control panel offers quick access to options related to the objects you select. By default, the Control panel is docked at the top of the workspace.

Options displayed in the Control panel vary depending on the type of object or tool you select. For example, when you select a text object, the Control panel displays text-formatting options in addition to options for changing the color, placement, and dimensions of the object. When a selection tool is active, you can access Document Setup and Preferences from the Control panel.



Control panel
A. Hidden options B. Link to another panel C. Panel menu

When text in the Control panel is blue and underlined, you can click the text to display a related panel or dialog box. For example, click the word *Stroke* to display the Stroke panel.

Change the kinds of controls that appear in the Control panel

- ❖ Select or deselect options in the Control panel menu.

Open and close a panel or dialog box from the Control panel

- 1 Click a blue underlined word to open its associated panel or dialog box.
- 2 Click anywhere outside of the panel or dialog box to close it.

Dock the Control panel at the bottom of the workspace

- ❖ Choose Dock To Bottom from the Control panel menu.

Convert the Control panel to a floating panel

- ❖ Drag the gripper bar (located on the left edge of the panel) away from its current position.

To redock the Control panel, drag the gripper bar to the top or bottom of the application window (Windows) or screen (Mac OS).

Customizing the workspace

Manage windows and panels

You can create a custom workspace by moving and manipulating Document windows and panels. You can also save workspaces and switch among them. For Fireworks, renaming custom workspaces can lead to unexpected behavior.

Note: The following examples use Photoshop for demonstration purposes. The workspace behaves the same in all the products.

Rearrange, dock, or float document windows

When you open more than one file, the Document windows are tabbed.

- To rearrange the order of tabbed Document windows, drag a window's tab to a new location in the group.
- To undock (float or untab) a Document window from a group of windows, drag the window's tab out of the group.

Note: In Photoshop you can also choose Window > Arrange > Float in Window to float a single Document window, or Window > Arrange > Float All In Windows to float all of the Document windows at once. See tech note [kb405298](#) for more information.

Note: Dreamweaver does not support docking and undocking Document windows. Use the Document window's Minimize button to create floating windows (Windows), or choose Window > Tile Vertically to create side-by-side Document windows. Search "Tile Vertically" in Dreamweaver Help for more information on this topic. The workflow is slightly different for Macintosh users.

- To dock a Document window to a separate group of Document windows, drag the window into the group.
- To create groups of stacked or tiled documents, drag the window to one of the drop zones along the top, bottom, or sides of another window. You can also select a layout for the group by using the Layout button on the Application bar.

Note: Some products do not support this functionality. However, your product may have Cascade and Tile commands in the Window menu to help you lay out your documents.

- To switch to another document in a tabbed group when dragging a selection, drag the selection over the document's tab for a moment.

Note: Some products do not support this functionality.

Dock and undock panels

A *dock* is a collection of panels or panel groups displayed together, generally in a vertical orientation. You dock and undock panels by moving them into and out of a dock.

- To dock a panel, drag it by its tab into the dock, at the top, bottom, or in between other panels.
- To dock a panel group, drag it by its title bar (the solid empty bar above the tabs) into the dock.
- To remove a panel or panel group, drag it out of the dock by its tab or title bar. You can drag it into another dock or make it free-floating.

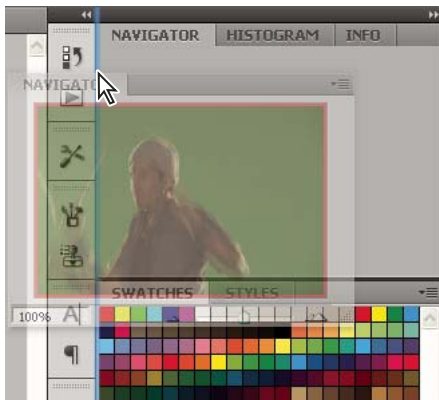

Navigator panel being dragged out to new dock, indicated by blue vertical highlight

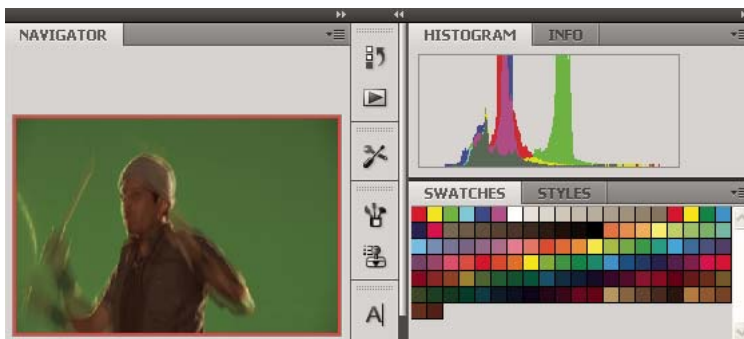

Navigator panel now in its own dock

💡 You can prevent panels from filling all the space in a dock. Drag the bottom edge of the dock up so it no longer meets the edge of the workspace.

Move panels

As you move panels, you see blue highlighted *drop zones*, areas where you can move the panel. For example, you can move a panel up or down in a dock by dragging it to the narrow blue drop zone above or below another panel. If you drag to an area that is not a drop zone, the panel floats freely in the workspace.

Note: The position of the mouse (rather than the position of the panel), activates the drop zone, so if you can't see the drop zone, try dragging the mouse to the place where the drop zone should be.

- To move a panel, drag it by its tab.
- To move a panel group, drag the title bar.

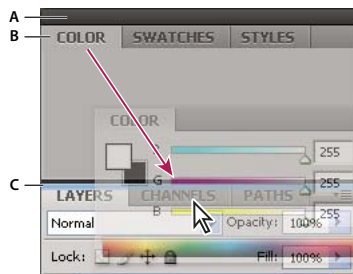

Narrow blue drop zone indicates Color panel will be docked on its own above the Layers panel group.

A. Title bar B. Tab C. Drop zone

💡 Press **Ctrl** (Windows) or **Command** (Mac OS) while moving a panel to prevent it from docking. Press **Esc** while moving the panel to cancel the operation.

Add and remove panels

If you remove all panels from a dock, the dock disappears. You can create a dock by moving panels to the right edge of the workspace until a drop zone appears.

- To remove a panel, right-click (Windows) or Control-click (Mac) its tab and then select Close, or deselect it from the Window menu.
- To add a panel, select it from the Window menu and dock it wherever you want.

Manipulate panel groups

- To move a panel into a group, drag the panel's tab to the highlighted drop zone in the group.

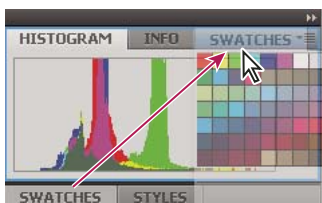

Adding a panel to a panel group

- To rearrange panels in a group, drag a panel's tab to a new location in the group.
- To remove a panel from a group so that it floats freely, drag the panel by its tab outside the group.
- To move a group, drag the title bar (the area above the tabs).

Stack floating panels

When you drag a panel out of its dock but not into a drop zone, the panel floats freely. The floating panel allows you to position it anywhere in the workspace. You can stack floating panels or panel groups so that they move as a unit when you drag the topmost title bar.

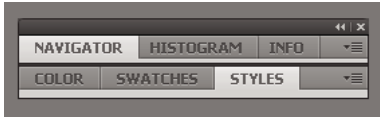

Free-floating stacked panels

- To stack floating panels, drag a panel by its tab to the drop zone at the bottom of another panel.
- To change the stacking order, drag a panel up or down by its tab.
Note: Be sure to release the tab over the narrow drop zone between panels, rather than the broad drop zone in a title bar.
- To remove a panel or panel group from the stack, so that it floats by itself, drag it out by its tab or title bar.

Resize panels

- To minimize or maximize a panel, panel group, or stack of panels, double-click a tab. You can also double-click the tab area (the empty space next to the tabs).
- To resize a panel, drag any side of the panel. Some panels, such as the Color panel in Photoshop, cannot be resized by dragging.

Collapse and expand panel icons

You can collapse panels to icons to reduce clutter on the workspace. In some cases, panels are collapsed to icons in the default workspace.

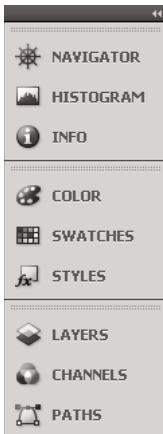

Panels collapsed to icons

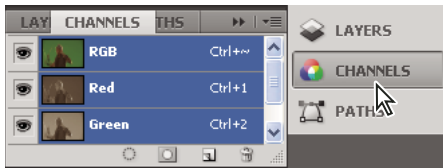

Panels expanded from icons

- To collapse or expand all panel icons in a column, click the double arrow at the top of the dock.
- To expand a single panel icon, click it.
- To resize panel icons so that you see only the icons (and not the labels), adjust the width of the dock until the text disappears. To display the icon text again, make the dock wider.
- To collapse an expanded panel back to its icon, click its tab, its icon, or the double arrow in the panel's title bar.

 *In some products, if you select Auto-Collapse Icon Panels from the Interface or User Interface Options preferences, an expanded panel icon collapses automatically when you click away from it.*

- To add a floating panel or panel group to an icon dock, drag it in by its tab or title bar. (Panels are automatically collapsed to icons when added to an icon dock.)
- To move a panel icon (or panel icon group), drag the icon. You can drag panel icons up and down in the dock, into other docks (where they appear in the panel style of that dock), or outside the dock (where they appear as floating icons).

Use panel menus

Access the panel menus using the  icon on the upper-right corner of the panel.

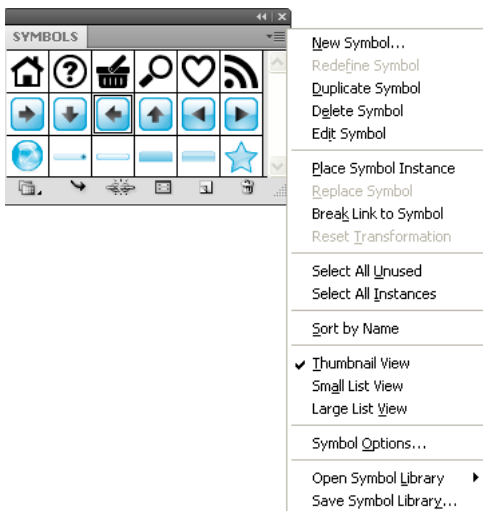

Panel menu (Symbols panel)

Rename or duplicate a workspace

- 1 Choose Window > Workspace > Manage Workspaces.
- 2 Do any of the following, and then click OK:
 - To rename a workspace, select it, and edit the text.

- To duplicate a workspace, select it, and click the New button.

For a video on customizing the workspace based on different workflows, see www.adobe.com/go/vid0032_en.

Save and switch workspaces

By saving the current size and position of panels as a named workspace, you can restore that workspace even if you move or close a panel. The names of saved workspaces appear in the workspace switcher in the Application bar.

Save a custom workspace

- 1 With the workspace in the configuration you want to save, do one of the following:
 - (Illustrator) Choose Window > Workspace > Save Workspace.
 - (Photoshop, InDesign, InCopy) Choose Window > Workspace > New Workspace.
 - (Dreamweaver) Choose Window > Workspace Layout > New Workspace.
 - (Flash) Choose New Workspace from the workspace switcher in the Application bar.
 - (Fireworks) Choose Save Current from the workspace switcher in the Application bar.
- 2 Type a name for the workspace.
- 3 (Photoshop, InDesign) Under Capture, select one or more options:
 - Panel Locations** Saves the current panel locations (InDesign only).
 - Keyboard shortcuts** Saves the current set of keyboard shortcuts (Photoshop only).
 - Menus or Menu Customization** Saves the current set of menus.

Display or switch workspaces

- ❖ Select a workspace from the workspace switcher in the Application bar.



In Photoshop, you can assign keyboard shortcuts to each workspace to navigate among them quickly.

Delete a custom workspace

- Select Manage Workspaces from the workspace switcher in the Application bar, select the workspace, and then click Delete. (The option is not available in Fireworks.)
- (Photoshop, InDesign, InCopy) Select Delete Workspace from the workspace switcher.
- (Illustrator) Choose Window > Workspace > Manage Workspaces, select the workspace, and then click the Delete icon.
- (Photoshop, InDesign) Choose Window > Workspace > Delete Workspace, select the workspace, and then click Delete.

Restore the default workspace

- 1 Select the Default or Essentials workspace from the workspace switcher in the application bar. For Fireworks, see the article http://www.adobe.com/devnet/fireworks/articles/workspace_manager_panel.html.

Note: In Dreamweaver, Designer is the default workspace.

- 2 For Fireworks (Windows), delete these folders:

Windows Vista \\Users\<<username>\AppData\Roaming\Adobe\Fireworks CS4\

Windows XP \\Documents and Settings\<<username>\Application Data\Adobe\Fireworks CS4

3 (Photoshop, InDesign, InCopy) Select Window > Workspace > Reset [*Workspace Name*].

(Photoshop) Restore a saved workspace arrangement

In Photoshop, workspaces automatically appear as you last arranged them, but you can restore the original, saved arrangement of panels.

- To restore an individual workspace, choose Window > Workspace > Reset *Workspace Name*.
- To restore all the workspaces installed with Photoshop, click Restore Default Workspaces in the Interface preferences.



To rearrange the order of workspaces in the application bar, drag them.

Tools

Tools panel overview

The first time you start the application, the Tools panel appears at the left side of the screen. You can move the Tools panel by dragging its title bar. You can also show or hide the Tools panel by choosing Window > Tools.

You use tools in the Tools panel to create, select, and manipulate objects in Illustrator. Some tools have options that appear when you double-click a tool. These include tools that let you use type, and select, paint, draw, sample, edit, and move images.

You can expand some tools to show hidden tools beneath them. A small triangle at the lower-right corner of the tool icon signals the presence of hidden tools. To see the name of a tool, position the pointer over it.

You can also use the Tools panel to change the drawing mode from Draw Normal to Draw Behind or Draw Inside.

Tools panel overview

A Selection tools

- Selection (V)
- Direct Selection (A)
- Magic Wand (Y)
- Lasso (Q)
- Artboard (Shift+O)

B Drawing tools

- Pen (P)
- Add Anchor Point (+)
- Delete Anchor (-) Point
- Convert Anchor Point (Shift+C)
- Line Segment (l)
- Arc
- Spiral
- Rectangular Grid
- Polar Grid
- Rectangle (M)
- Rounded Rectangle
- Ellipse (L)
- Polygon
- Star
- Flare
- Pencil (N)
- Smooth
- Path Eraser
- Perspective Grid (Shift+P)
- Perspective Selection (Shift+V)

C Type tools

- Type (T)
- Area Type
- Type On a Path
- Vertical Type
- Vertical Area Type
- Vertical Type On a Path

D Painting tools

- Paintbrush (B)
- Blob Brush (Shift+B)
- Mesh (U)
- Gradient (G)
- Eyedropper (I)
- Measure
- Live Paint Bucket (K)
- Live Paint Selection (Shift+L)

E Reshaping tools

- Rotate (R)
- Reflect (O)
- Scale (S)
- Shear
- Reshape
- Width (Shift+W)
- Warp (Shift-R)
- Twirl
- Pucker
- Bloat
- Scallop
- Crystallize
- Wrinkle
- Free Transform (E)
- Shape Builder (Shift+M)
- Blend (W)

F Symbol tools

- Symbol Sprayer (Shift+S)
- Symbol Shifter
- Symbol Scruncher
- Symbol Sizer
- Symbol Spinner
- Symbol Stainer
- Symbol Screener
- Symbol Styler

G Graph tools

- Column Graph (J)
- Stacked Column Graph
- Bar Graph
- Stacked Bar Graph
- Line Graph
- Area Graph
- Scatter Graph
- Pie Graph
- Radar Graph

H Slicing and cutting tools

- Slice (Shift+K)
- Slice Select
- Eraser (Shift+E)
- Scissors (C)
- Knife

I Moving and zooming tools

- Hand (H)
- Print Tiling
- Zoom (Z)

■ Indicates default tool
* Keyboard shortcuts appear in parenthesis

Tools panel overview

View hidden tools

- ❖ Hold down the mouse button on the visible tool.

View tool options

- ❖ Double-click a tool in the Tools panel.

Move the Tools panel

- ❖ Drag its title bar.

View the Tools panel in double-stack or single-column

- ❖ Click the double-arrow on the title bar to toggle between double-stack and single-column view of the Tools panel.

Hide the Tools panel

- ❖ Choose Window > Tools.

Tear off hidden tools into a separate panel

- ❖ Drag the pointer over the arrow at the end of the hidden tools panel and release the mouse button.

Close a separate tool panel

- ❖ Click the close button on the panel's title bar. The tools return to the Tools panel.

Select a tool

- ❖ Do one of the following:
 - Click a tool in the Tools panel. If there is a small triangle at a tool's lower-right corner, hold down the mouse button to view the hidden tools, and then click the tool you want to select.
 - Hold down Alt (Windows) or Option (Mac OS), and then click a tool to cycle through and select hidden tools.
 - Press the tool's keyboard shortcut. The keyboard shortcut is displayed in its tool tip. For example, you can select the Move tool by pressing the V key.

💡 To hide tool tips, choose Edit > Preferences > General (Windows) or Illustrator > Preferences > General (Mac OS), and deselect Show Tool Tips.

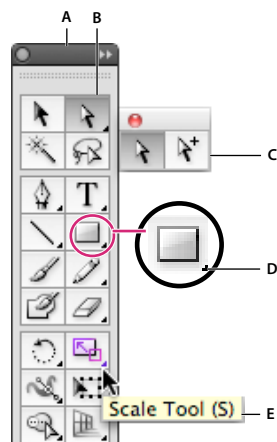

Selecting a hidden tool

A. Tools panel B. Active tool C. Tear off panel with hidden tools D. Hidden tool triangle E. Tool name and shortcut

Change tool pointers

The mouse pointer for most tools matches the tool's icon. Each pointer has a different hotspot, where an effect or action begins. With most tools, you can switch to precise cursors, which appear as cross hairs centered around the hotspot, and provide for greater accuracy when working with detailed artwork.

- ❖ Choose Edit > Preferences > General (Windows) or Illustrator > Preferences > General (Mac OS), and select Use Precise Cursors. Alternatively, press Caps Lock on the keyboard.

Tool galleries

Illustrator provides many tools for creating and manipulating your artwork. These galleries provide a quick visual overview for each tool.

Selection tool gallery

Illustrator provides the following selection tools:

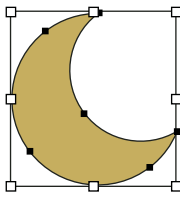

The Selection tool (V) selects entire objects.

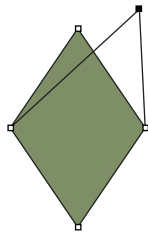

The Direct Selection tool (A) selects points or path segments within objects.

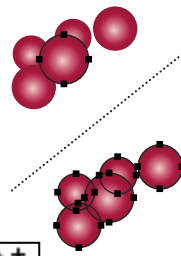

The Group Selection tool selects objects and groups within groups.

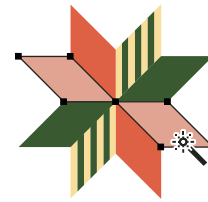

The Magic Wand tool (Y) selects objects with similar attributes.

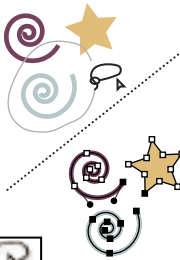

The Lasso tool (Q) selects points or path segments within objects.

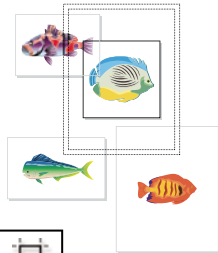

The Artboard tool creates separate artboards for printing or export.

More Help topics

[“Keys for selecting”](#) on page 478

Drawing tool gallery

Illustrator provides the following drawing tools:

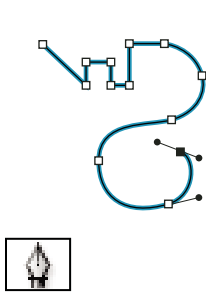

The Pen tool (P) draws straight and curved lines to create objects.

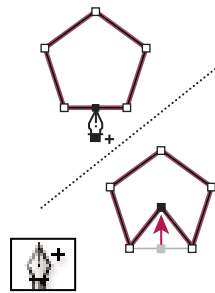

The Add Anchor Point tool (+) adds anchor points to paths.

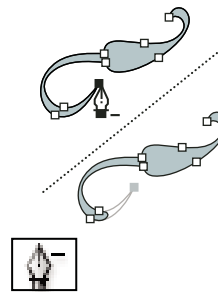

The Delete Anchor Point tool (-) deletes anchor points from paths.

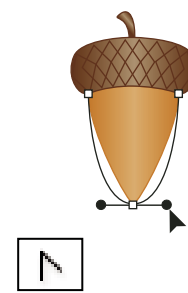

The Convert Anchor Point tool (Shift+C) changes smooth points to corner points and vice versa.



The Line Segment tool (\) draws individual straight line segments.

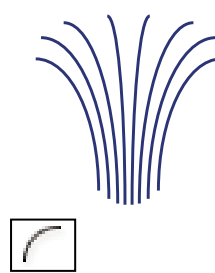

The Arc tool draws individual concave or convex curve segments.

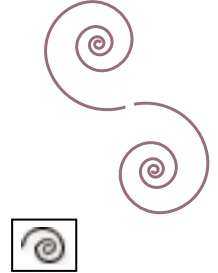

The Spiral tool draws clockwise and counterclockwise spirals.

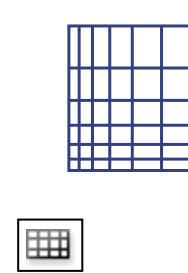

The Rectangular Grid tool draws rectangular grids.



The Polar Grid tool draws circular chart grids.

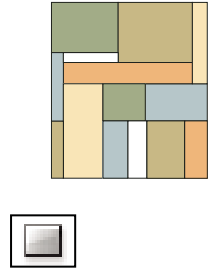

The Rectangle tool (M) draws squares and rectangles.

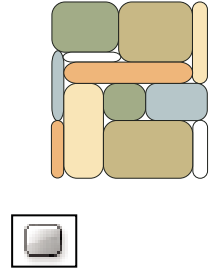

The Rounded Rectangle tool draws squares and rectangles with rounded corners.

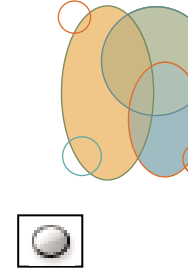

The Ellipse tool (L) draws circles and ovals.

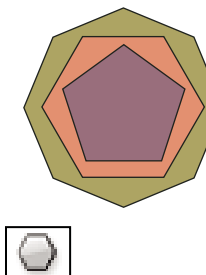

The Polygon tool draws regular, multi-sided shapes.

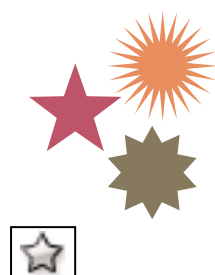

The Star tool draws stars.

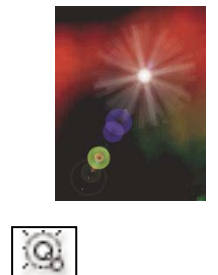

The Flare tool creates lens-flare or solar-flare-like effects.

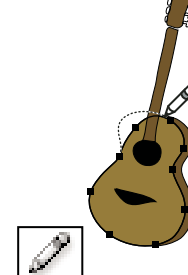

The Pencil tool (N) draws and edits freehand lines.

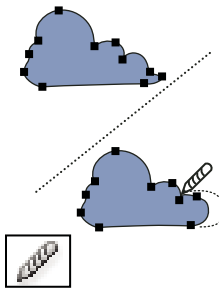

The Smooth tool smooths Bezier paths.

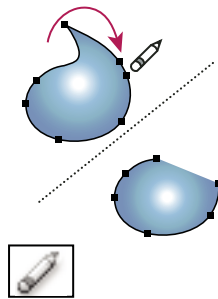

The Path Eraser tool erases paths and anchor points from the object.



The Perspective Grid allows creating and rendering artwork in perspective.



The Perspective Selection tool allows you to bring objects, text, and symbols in perspective, move objects in perspective, move objects in perpendicular to its current direction.

Type tool gallery

Illustrator provides the following type tools:

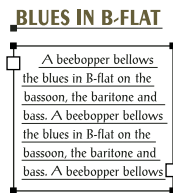

The Type tool (T) creates individual type and type containers and lets you enter and edit type.

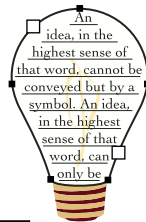

The Area Type tool changes closed paths to type containers and lets you enter and edit type within them.



The Type On A Path tool changes paths to type paths, and lets you enter and edit type on them.

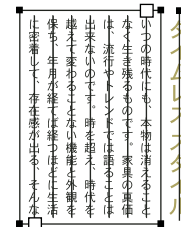

The Vertical Type tool creates vertical type and vertical type containers and lets you enter and edit vertical type.

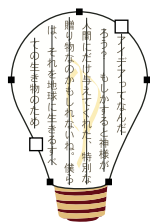

The Vertical Area Type tool changes closed paths to vertical type containers and lets you enter and edit type within them.



The Vertical Type On A Path tool changes paths to vertical type paths and lets you enter and edit type on them.

Painting tool gallery

Illustrator provides the following painting tools:

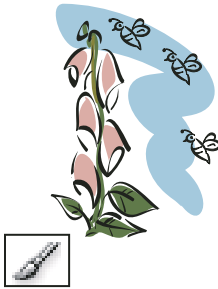

The Paintbrush tool (B) draws freehand and calligraphic lines, as well as art, patterns, and bristle brush strokes on paths.

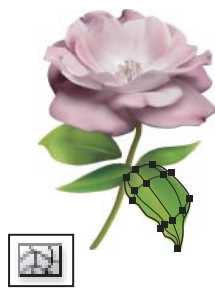

The Mesh tool (U) creates and edits meshes and mesh envelopes.

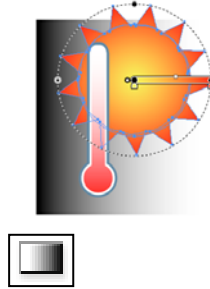

The Gradient tool (G) adjusts the beginning and ending points and angle of gradients within objects, or applies a gradient to objects.



The Eyedropper tool (I) samples and applies color, type, and appearance attributes, including effects, from objects.

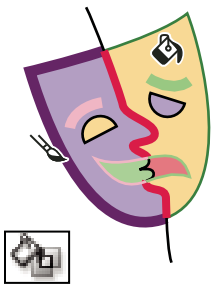

The Live Paint Bucket tool (K) paints faces and edges of Live Paint groups with the current paint attributes.

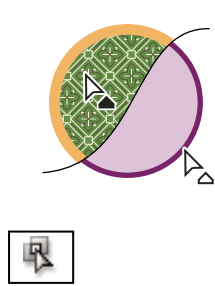

The Live Paint Selection (Shift-L) tool selects faces and edges within Live Paint groups.

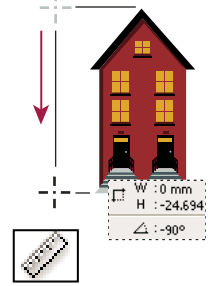

The Measure tool measures the distance between two points.

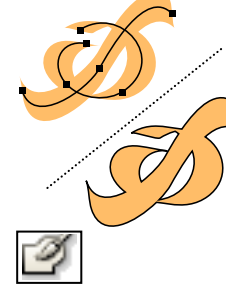

The Blob Brush tool (Shift-B) draws paths that automatically expand and merge calligraphic brush paths that share the same color and are adjacent in stacking order.

Reshaping tool gallery

Illustrator provides the following tools for reshaping objects:

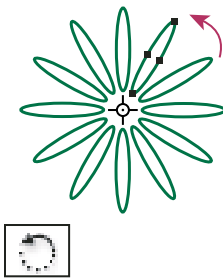

The Rotate tool (R) rotates objects around a fixed point.

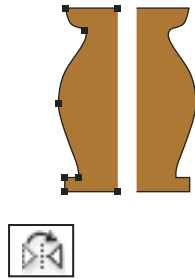

The Reflect tool (O) flips objects over a fixed axis.

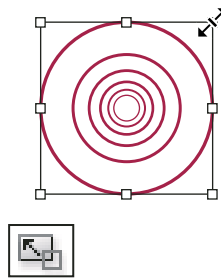

The Scale tool (S) resizes objects around a fixed point.

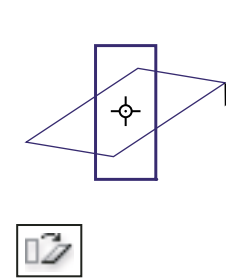

The Shear tool skews objects around a fixed point.

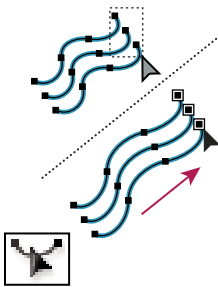

The Reshape tool adjusts selected anchor points while keeping the overall detail of the path intact.

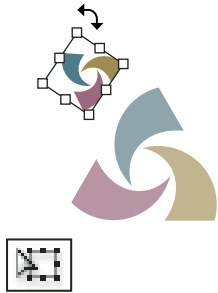

The Free Transform tool (E) scales, rotates, or skews a selection.

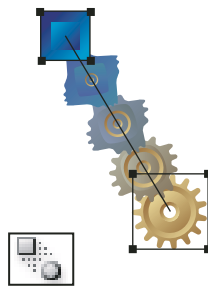

The Blend tool (W) creates a series of objects blended between the color and shape of multiple objects.

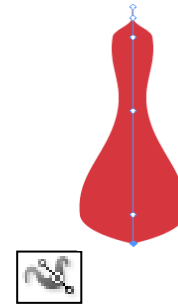

The Width tool (Shift+W) allows you to create a stroke with variable width.

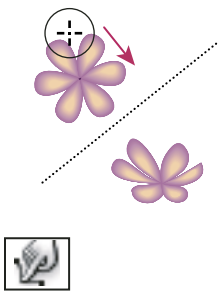

The Warp tool (Shift+R) molds objects with the movement of the cursor (like molding clay, for example).

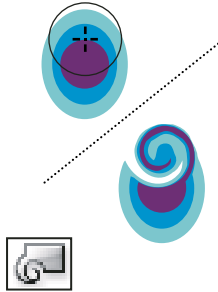

The Twirl tool creates swirling distortions within an object.

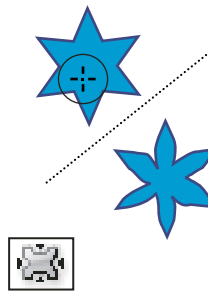

The Pucker tool deflates an object by moving control points towards the cursor.

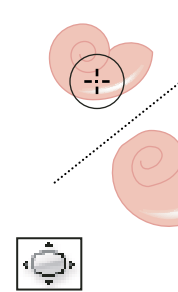

The Bloat tool inflates an object by moving control points away from the cursor.

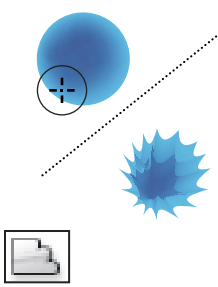

The Scallop tool adds random curved details to the outline of an object.

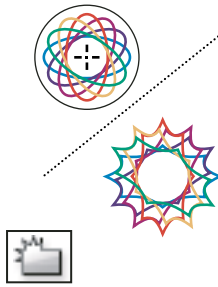

The Crystallize tool adds random spiked details to the outline of an object.

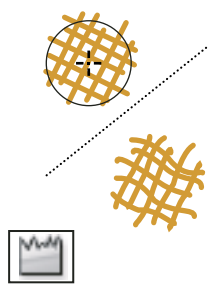

The Wrinkle tool adds wrinkle-like details to the outline of an object.

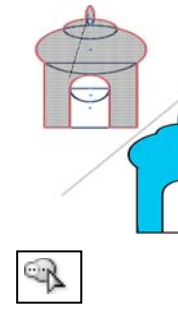

The Shape Builder tool merges simple shapes to create custom, complex shapes

Symbolism tool gallery

The symbolism tools let you create and modify sets of symbol instances. You create a symbol set using the Symbol Sprayer tool. You can then use the other symbolism tools to change the density, color, location, size, rotation, transparency, and style of the instances in the set.

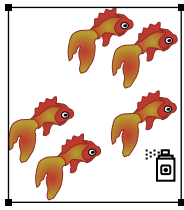

The Symbol Sprayer tool (Shift+S) places multiple symbol instances as a set on the artboard.

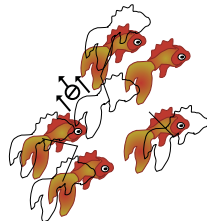

The Symbol Shifter tool moves symbol instances

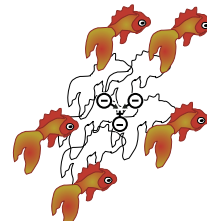

The Symbol Scruncher tool moves symbol instances closer together or farther apart.

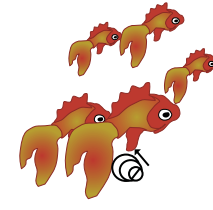

The Symbol Sizer tool resizes symbol instances.

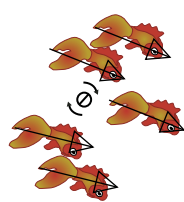

The Symbol Spinner tool rotates symbol instances.

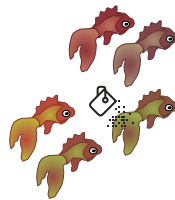

The Symbol Stainer tool colorizes symbol instances.

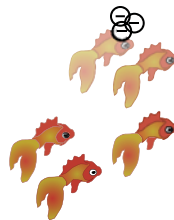

The Symbol Screener tool applies opacity to symbol instances.

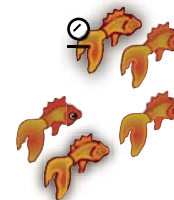

The Symbol Styler tool applies the selected style to symbol instances.

Graph tool gallery

Illustrator provides nine graph tools, each one for creating a different type of graph. The type of graph you choose depends on the information you want to communicate.

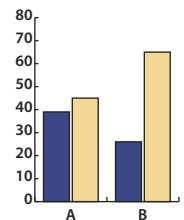

The Column Graph tool (J) creates graphs that compare values using vertical columns.

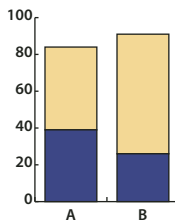

The Stacked Column Graph tool creates graphs that are similar to column graphs, but stacks the columns on top of one another, instead of side by side. This graph type is useful for showing the relationship of parts to the total.

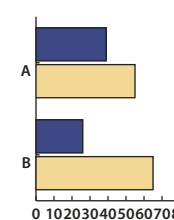

The Bar Graph tool creates graphs that are similar to column graphs, but positions the bars horizontally instead of vertically.

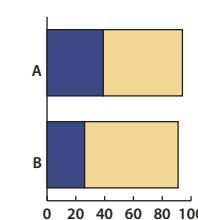

The Stacked Bar Graph tool creates graphs that are similar to stacked column graphs, but stacks the bars horizontally instead of vertically.

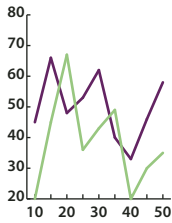

The Line Graph tool creates graphs that use points to represent one or more sets of values, with a different line joining the points in each set. This type of graph is often used to show the trend of one or more subjects over a period of time.

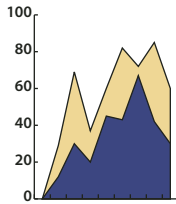

The Area Graph tool creates graphs that are similar to line graphs, but emphasizes totals as well as changes in values.

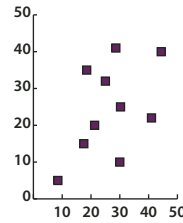

The Scatter Graph tool creates graphs that plot data points as paired sets of coordinates along the x and y axes. Scatter graphs are useful for identifying patterns or trends in data. They also can indicate whether variables affect one another.



The Pie Graph tool creates circular graphs whose wedges represent the relative percentages of the values compared.

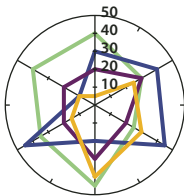

The Radar Graph tool creates graphs that compare sets of values at given points in time or in particular categories, and is displayed in a circular format. This type of graph is also called a web graph.

Slicing and cutting tool gallery

Illustrator provides the following tools for slicing and cutting objects:

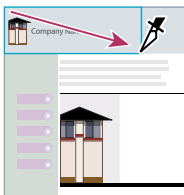

The Slice tool divides artwork into separate web images.

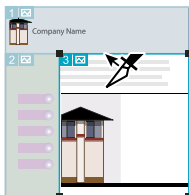

The Slice Selection tool (Shift-K) selects web slices.

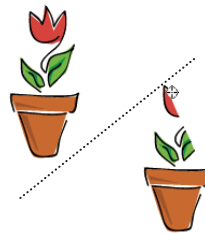

The Eraser tool (Shift-E) erases any area of the object over which you drag.

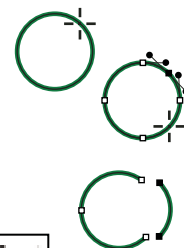

The Scissors tool (C) cuts paths at specified points.

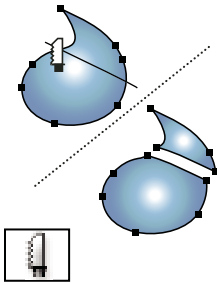

The Knife tool cuts objects and paths.

Moving and zooming tool gallery

Illustrator provides the following tools for moving around in and controlling the view of the artboard:

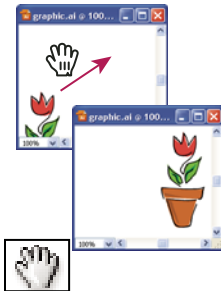

The Hand tool (H) moves the Illustrator artboard within the illustration window.

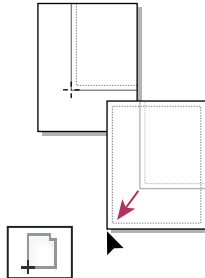

The Print Tiling tool adjusts the page grid to control where artwork appears on the printed page.



The Zoom tool (Z) increases and decreases the view magnification in the illustration window.

Files and templates

About new document profiles

A *document* is the space in which you create artwork. In Illustrator, you can create documents destined for many different types of output. (For information on creating Illustrator documents for video production, see the Enhancing Video Production PDF at www.adobe.com/go/learn_ai_video.)

You start a new document by choosing a new document profile based on your intended output. Each profile includes preset values for size, color mode, units, orientation, transparency, and resolution. All use one artboard, by default. For example, the Video And Film Document profile uses pixels instead of points, and you can choose a device-specific crop area, such as NTSC DV Widescreen, to create a document in the exact dimensions required, with video-safe guides in place to help you lay out your design for optimal viewing.

 *If you plan to output your file to a high-end printer, for example if you're sending it to a service bureau, specify the Print profile to ensure your artwork and any effects applied to the artwork are set to the proper resolution.*

You can choose from the following profiles:

Print Document Uses a default letter size artboard, and provides a variety of other preset print sizes to choose from. Use this profile if you plan to send this file to a service bureau for output to a high-end printer.

Web Document Provides preset options optimized for output to the web.

Flash Catalyst Creates an FXG document in RGB mode with 800px x 600px artboard as the default size. Align to Pixel Grid is enabled for new art in the document and the Raster Effects Resolution is set to 72ppi. It also has Swatches, Symbols, Graphic Styles and Brushes designed keeping Flash Catalyst and Flash Professional workflows in mind.

Mobile And Devices Document Creates a small file size that is preset for a specific mobile device. You can choose your device from the Size menu. Click Device Central to open Adobe Device Central and view the document layout in a specified device interface.

Video And Film Document Provides several preset video- and film-specific crop area sizes (note that the Artboard option changes to Crop Size for this profile). Illustrator creates only square pixel files, so to ensure that the sizes are interpreted correctly in video applications, Illustrator adjusts the Width and Height values. For example, if you choose NTSC DV Standard, Illustrator uses a pixel size of 654 x 480, which translates to 740 x 480 pixels in video-based applications.

Basic CMYK Document Uses a default letter size artboard, and provides a variety of other sizes to choose from. Use this profile if you plan to send a document to multiple types of media. If one of the media types is a service bureau, you'll want to manually increase the Raster Effects setting to High.

Basic RGB Document Uses a default 800 x 600 size artboard, and provides a variety of other print-, video-, and web-specific sizes to choose from. Do not use this option if you plan to send a document to a service bureau or output to a high-end printer. Use this profile for documents that will be output to mid-level printers, to the web, or multiple types of media.

For a video on setting up new documents, see www.adobe.com/go/vid0031.

For more information about creating custom new document profiles, see www.adobe.com/go/learn_custom_document_profiles_en.

More Help topics

[New document video](#)

[Video production](#)

Create new documents

You can create new Illustrator documents from a new document profile or from a template. Creating a document from a new document profile gives you a blank document with the selected profile's default fill and stroke colors, graphic styles, brushes, symbols, actions, viewing preferences, and other settings. Creating a document from a template gives you a document with preset design elements and settings, as well as content, such as cropmarks and guides, for specific document types, such as brochures or CD covers.

You create a new document from the Welcome screen, or by using File > New or File > Device Central (for mobile device output). To view the Welcome screen, select Help > Welcome.

For a video on setting up new documents, see www.adobe.com/go/vid0031.

More Help topics

[“About new document profiles”](#) on page 25

[“About templates”](#) on page 28

[“About transparency”](#) on page 180

[“Using Adobe Device Central with Illustrator”](#) on page 386

Create a new document

You can start a new document from the Welcome screen or from the File menu.

1 Do one of the following:

- If Illustrator is already open, choose File > New and from New Document Profile select the required document profile.
- If the Welcome screen is open, click a document profile from the Create New list.
- If Illustrator is not open, open it and click a document profile from the Create New list in the Welcome screen.

Note: In the Welcome screen, you can Alt-click (Windows) or Option-click (Mac OS) to open the new document directly and skip the New Document dialog box.

2 Type a name for your document.

3 Specify the number of artboards for your document, and the order you'd like them laid out on screen:

Grid By Row Arranges multiple artboards in the specified number of rows. Choose the number of rows from the Rows menu. The default value creates the most square appearance possible with the specified number of artboards.

Grid By Column Arranges multiple artboards in the specified number of columns. Choose the number of columns from the Columns menu. The default value creates the most square appearance possible with the specified number of artboards.

Arrange By Row Arranges artboards in one straight row.

Arrange By Column Arranges artboards in one straight column.

Change To Right-To-Left Layout Arranges multiple artboards in the specified row or column format, but displays them from right to left.

4 Specify the default spacing between artboards. This setting applies to both horizontal and vertical spacing.

5 Specify the default size, units of measure, and layout for all artboards.

Note: Once your document opens, you can customize your artboards by moving and resizing them as desired.

6 Specify the position of the bleed along each side of the artboard. To use different values for different sides, click the Lock icon .

7 Click Advanced to specify the following additional options:

Note: You can change these settings after you create the document by choosing File > Document Setup and specifying new settings.

Color Mode Specifies the color mode for the new document. Changing the color mode converts the default contents (swatches, brushes, symbols, graphic styles) of the selected new document profile to a new color mode, resulting in a color change. Watch for a warning icon when making changes.

Raster Effects Specifies the resolution for raster effects in the document. It is especially important to set this at High when you plan to output to a high-end printer at high resolution. The Print profile sets this at High by default.

Transparency Grid Specifies the options for the transparency grid for documents that use the Video And Film profile.

Preview Mode Sets the default preview mode for the document (you can change this at any time by using the View menu):

- *Default* displays artwork created in the document in vector view with full color. Zoom in/out retains smoothness in the curves.
- *Pixel* displays artwork with a rasterized (pixelated) appearance. It does not actually rasterize the content, but displays a simulated preview, as if the contents were rasters.

- *Overprint* provides an “ink preview” that approximates how blending, transparency, and overprinting will appear in color-separated output. (See “[About overprinting](#)” on page 438.)

Device Central If you’ve created a document using the Mobile and Devices profile, you can click Device Central to preview your new document in the mobile device interface.

Align New Objects to Pixel Grid This option, if selected, aligns any new objects to the pixel grid. Because this option is important for designs intended for display devices such as web, it is enabled by default for such documents. For more information, see “[Drawing pixel-aligned paths for web workflows](#)” on page 58.

Create a new document from a template

1 Do one of the following:

- Choose File > New From Template.
- Choose File > New. In the New Document dialog box, click Templates.
- In the Welcome screen, click From Template in the Create New list.

2 In the New From Template dialog box, locate and select a template, and click New.

About templates

Templates let you create new documents that share common settings and design elements. For example, if you need to design a series of business cards with a similar look and feel, you can create a template with the desired artboard size, view settings (such as guides), and print options. The template can also contain symbols for common design elements (such as logos) and specific sets of color swatches, brushes, and graphic styles.

Illustrator comes with a variety of templates, including templates for letterhead, business cards, envelopes, brochures, labels, certificates, postcards, greeting cards, and websites.

When a template is selected via the New From Template command, Illustrator creates a new document with identical content and document settings as the template, but leaves the original template file untouched.

More Help topics

“[Create new documents](#)” on page 26

Create a new template

1 Open a new or existing document.

2 Customize the document in any of the following ways:

- Set up the document window as you want it to appear in new documents you create from the template. This includes the magnification level, scroll position, ruler origin, guides, grids, crop areas, and options in the View menu.
- Draw or import any artwork you want to appear in new documents you create from the template.
- Delete any existing swatches, styles, brushes, or symbols, you don’t want to retain.
- Create any new swatches, styles, brushes, and symbols, you want in the corresponding panels. You can also import preset swatches, styles, brushes, symbols, and actions from a variety of libraries that come with Illustrator.
- Create any graph designs you want and add them to the Graph Design dialog box. You can also import preset graph designs.
- Set the desired options in the Document Setup dialog box and Print Options dialog box.

3 Choose File > Save As Template.

4 In the Save As dialog box, select a location for the file, enter a filename, and click Save.

Illustrator saves the file in AIT (Adobe Illustrator Template) format.

Specify document setup options

At any point you can change your document's default setup options for units of measure, transparency grid display, background color, and type settings such as language, quote style, superscript and subscript size, and exportability. The Edit Artboards button closes this dialog box and activates the Artboard tool. Use this button if you want to modify your artboards.

1 Choose File > Document Setup or click the Document Setup button in the Control panel (this button is visible when nothing is selected).

2 Specify options as desired.

Note: The Simulate Colored Paper option is useful if you plan to print the document on colored paper. For example, if you draw a blue object on a yellow background, the object appears green. The simulation is performed only when the transparency grid is not shown.

For specific information on these options, see related topics.

More Help topics

[“Change the unit of measurement”](#) on page 43

[“View transparency in artwork”](#) on page 181

[“Specify curly or straight quotes”](#) on page 326

[“Creating superscripts or subscripts”](#) on page 326

Open a file

You can open files that were created in Illustrator as well as compatible files that were created in other applications.

- To open an existing file, choose File > Open. Locate the file, and click Open.
- To open a recently saved file, choose the file from the Open A Recent Item list in the Welcome screen, or choose File > Open Recent Files, and choose a file from the list.
- To open and preview a file using Adobe Bridge, choose File > Browse In Bridge to open Adobe Bridge. Locate the file and choose File > Open With > Adobe Illustrator CS5.

More Help topics

[“Importing Adobe PDF files”](#) on page 273

[“Importing EPS files”](#) on page 274

[“Importing artwork from Photoshop”](#) on page 276

Browse for files using Adobe Bridge

Adobe® Bridge is a cross-platform application included with Adobe® Creative Suite® 5 components that helps you locate, organize, and browse the assets you need to create print, web, video, and audio content. You can start Bridge from any Creative Suite component, and use it to access both Adobe and non-Adobe asset types.

- ❖ To open Adobe Bridge, do one of the following from within Illustrator:
 - Choose File > Browse In Bridge.
 - Click the Adobe Bridge icon  in the Control panel.
 - Choose Reveal In Bridge from the status bar.

From Adobe Bridge, you can do any of the following:

- Manage image, footage, and audio files: Preview, search, sort, and process files in Bridge without opening individual applications. You can also edit metadata for files, and use Bridge to place files into your documents, projects, or compositions.
- Manage your photos: Import and edit photos from your digital camera card, group related photos in stacks, and open or import Photoshop® Camera Raw files and edit their settings without starting Photoshop.
- Perform automated tasks, such as batch commands.
- Synchronize color settings across color-managed Creative Suite components.
- Start a real-time web conference to share your desktop and review documents.

Working with ConnectNow

Working with ConnectNow

Adobe® ConnectNow provides you with a secure, personal online meeting room where you can meet and collaborate with others via the web in real time. With ConnectNow, you can share and annotate your computer screen, send chat messages, and communicate using integrated audio. You can also broadcast live video, share files, capture meeting notes, and control an attendee's computer.

You can access ConnectNow directly from the application interface.

- 1 Choose File > Share My Screen.
- 2 In the Sign In to Adobe CS Live dialog box, enter your email address and password, and click Sign In. If you don't have an Adobe ID, click the Create Adobe ID button.
- 3 To share your screen, click the Share My Computer Screen button at the center of the ConnectNow application window.

For complete instructions on using ConnectNow, see http://help.adobe.com/en_US/Acrobat.com/ConnectNow/index.html.

For a video tutorial about using ConnectNow, see [Using ConnectNow to share your screen \(7:12\)](#). (This demonstration is in Dreamweaver.)

Using multiple artboards

Artboard overview

Artboards represent the regions that can contain printable artwork. You resize and set the orientation for your artwork by choosing settings in the Artboard Options dialog box. (In Illustrator CS3 and earlier, you use the Document Setup dialog box to change the document size and orientation.)

You can use artboards as crop areas for printing or placement purposes—they work the same way as crop areas work in Illustrator CS3. Multiple artboards are useful for creating a variety of things such as multiple page PDFs, printed pages with different sizes or different elements, independent elements for websites, video storyboards, or individual items for animation in Adobe Flash or After Effects.

***Note:** If you created crop areas in an Illustrator CS3 document, the crop areas will be converted to artboards in CS5. You may be prompted to specify how you want the crop areas to convert.*

You can have 1 to 100 artboards per document depending on size. You can specify the number of artboards for a document when you first create it, and you can add and remove artboards at any time while working in a document. You can create artboards in different sizes, resize them by using the Artboard tool , and position them anywhere on the screen—even overlapping one another. Illustrator CS5 also provides options to reorder and rearrange artboards using the Artboards panel. You can also specify custom names for an artboard and set reference points for artboards.

To see a video on using multiple artboards and the Artboards panel, see www.adobe.com/go/lrvid5202_ai_en.

Viewing artboards and the canvas

You can view the page boundaries in relation to an artboard by showing print tiling (View > Show Print Tiling). When print tiling is on, the printable and nonprintable areas are represented by a series of solid and dotted lines between the outermost edge of the window and the printable area of the page.

Each artboard is bounded by solid lines and represents the maximum printable area. To hide the artboard boundaries, choose View > Hide Artboards. The canvas is the area outside the artboard that extends to the edge of the 220 inch square window. The canvas represents a space on which you can create, edit, and store elements of artwork before moving them onto an artboard. Objects placed onto the canvas are visible on-screen, but they do not print.

To center an artboard and zoom it to fit the screen, click the artboard number in the status bar, located at the bottom of the application window.

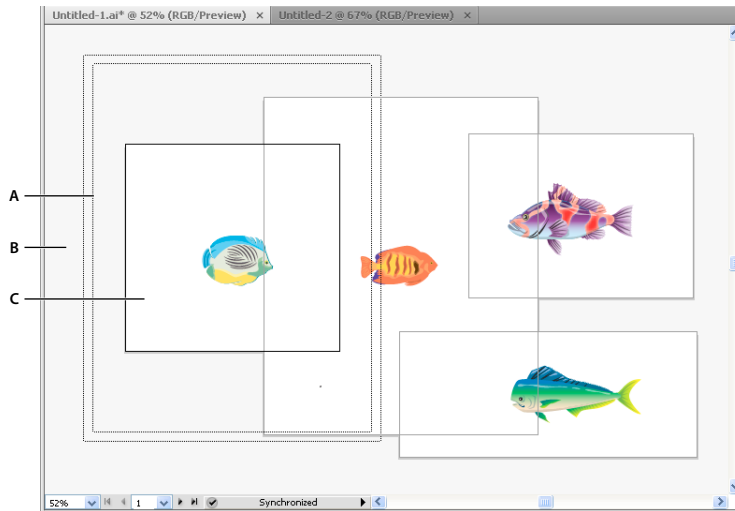

Illustration window
A. Printable area (determined by the specified printer) B. Canvas C. Artboard

Printing and saving artboards

All artboards in a document share the same media type format, such as Print. You can print each artboard individually, tiled, or combined into one page. If you save a multiple-artboard Illustrator document to a previous version of Illustrator, such as CS3, you can choose to save each artboard as a separate file, along with a master file that includes all artboards merged.

Illustrator CS4 allowed you to save artboards as separate files only when downsaved, but in Illustrator CS5, you can save individual artboards for current versions as well. The options to save each artboard as a separate .ai file is available in the Illustrator Options dialog box.

You can preview artboards from the print dialog box before printing them. The print settings you choose are applied to all of the artboards you selected to print.

By default all artwork is cropped to an artboard and all artboards print as individual pages. Use the Range option in the Print dialog box to print specific pages, select Ignore Artboards and specify placement options to combine all art onto a single page or tile the artwork as desired.

In Illustrator CS5, artboards in a document can automatically rotate to print to the chosen media size. Select the Auto-Rotate check box in the Print dialog box to set auto rotation for Illustrator documents. For a document created in CS5, Auto-Rotate is enabled by default.

For example, consider a document with both landscape (width is more than height) and portrait (height is more than width) media size. If you select the paper size as portrait in the Size of the Print dialog box, then the landscape artboards automatically rotate to portrait media when printing.

Note: If Auto-Rotate is selected, you cannot change the direction of the page.



More Help topics

[“Change the page size and orientation”](#) on page 417

[“Reposition artwork on the page”](#) on page 415

[“Tile artwork on multiple pages”](#) on page 416

Artboard options

You open the Artboard Options dialog box by double-clicking the Artboard tool , or clicking the Artboard tool and then clicking Artboard Options button  in the Control panel.

Preset Specifies artboard dimensions. These presets set the video ruler pixel aspect ratio appropriately for the specified output.

Width and Height Specifies the size of the artboard.

Orientation Specifies portrait or landscape page orientation.

Constrain Proportions Keeps the aspect ratio of the artboard intact if you manually resize it.

X: and Y: Position Specifies the position of the artboard according to Illustrator's workspace rulers. To view these rulers, choose View > Show Rulers.

Show Center Mark Displays a point in the center of the artboard.

Show Cross Hairs Displays cross lines through the center of each side of the artboard.

Show Video Safe Areas Displays guides that represent the areas that fall inside the viewable area of video. You want to keep all text and art that must be viewable to users inside the video safe areas.

Video Ruler Pixel Aspect Ratio Specifies the pixel aspect ratio used for the video rulers.

Fade Region Outside Artboard Displays the area outside of the artboard a darker shade than the area inside the artboard when the Artboard tool is active.

Update While Dragging Keeps the area outside of the artboard darker as you drag to resize the artboard. If this is not selected, the outside area displays in the same color as inside the artboard while resizing.

Artboards Indicates how many artboards exist.

Artboards panel

The Artboards panel allows you to perform various artboard operations such as:

- Add, reorder, rearrange, and delete artboards
- Reorder and renumber artboards
- Select and navigate through multiple artboards
- Specify artboard options such as presets, Artboard size, and relative artboard position

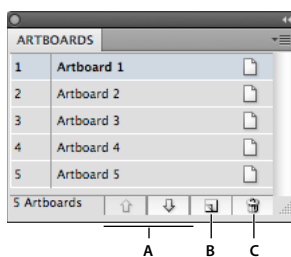

Artboards panel

A. Up and Down Arrows to reorder artboards in the Artboards panel B. Add new artboards C. Delete artboards



- To access the Artboards panel, click Window > Artboards.
- To add artboards, do any one of the following:
 - Click the New Artboard icon at the bottom of the Artboards panel.

- Select the New Artboard option from the Artboards panel menu (flyout menu) of the Artboards panel.
- To delete a single artboard or multiple artboards, do the following:
 - Select the artboard to delete. To delete multiple artboards, press Shift key, and click the artboards listed in the Artboards panel.
 - Click the Delete Artboard icon at the bottom of the Artboards panel or select the Delete option from the Artboards panel menu (flyout menu). To delete multiple non-contiguous artboards, press Ctrl (Windows) or Command (Mac OS) key and click the artboards from the Artboards panel.
- To rearrange artboards in the Artboards panel, select the Rearrange Artboards option from the Artboards panel menu (flyout menu). Notice, however, that rearranging the artboards does not change the order the artboards.
- To duplicate artboards, do the following:
 - Select the artboard that you want to duplicate. You can also duplicate artboards by dragging one or more artboards on to the new artboard button in Artboards panel.
 - From the Artboards panel menu, select Duplicate.
- To reset the artboard options, such as presets, artboard position, and display, select Artboards Options from the Artboards panel menu (flyout menu).

For a video on using the Artboards panel, see www.adobe.com/go/lrvid5202_ai_en.

Create an artboard

1 Do any of the following:



- To create a custom artboard, select the Artboard tool , and drag in the workspace to define the shape, size, and location.
- To use a preset artboard, double-click the Artboard tool, select a preset in the Artboard Options dialog box, and click OK. Drag the artboard to position it where you want.
- To create an artboard within an active artboard, hold down Shift and drag using the Artboard tool.
- To duplicate an existing artboard, select the Artboard tool, click to select the artboard you want to duplicate, and click the New Artboard button in the Control panel ; then click where you want to place the duplicated artboard. To create multiple duplicates, Alt-click as many times as you want. Or, using the Artboard tool, Alt-drag (Windows) or Option-drag (Mac OS) the artboard you want to duplicate.
- To duplicate an artboard with the contents, select the Artboard tool, click to select the Move/Copy Artwork With Artboard icon on the Control panel , press Alt (Windows) or Option (Mac OS), and then drag.

If you want the artwork to contain a bleed, make sure that there's enough artwork beyond the artboard rectangle to accommodate the bleed.

2 To commit the artboard and exit the artboard-editing mode, click a different tool in the Tools panel or click Esc.

To see a video on using multiple artboards, see www.adobe.com/go/lrvid5202_ai_en.

Delete an artboard

- ❖ Click the artboard and press Delete, click Delete  in the Control panel, or click the Delete icon  in an artboard's upper-right corner. You can delete all but the last remaining artboard.

Select and view artboards

1 Select the Artboard tool .

2 Do any of the following:

- Click an artboard to make it active. (Clicking in or drawing over an artboard using a different tool will also make the Artboard tool active.) If artboards overlap, the artboard with the left edge closest to the click location becomes the active artboard.
- To navigate between artboards, press Alt (Windows) or Option (Mac OS) and click an arrow key.
- To view artboards and their contents as outlines, right-click and choose Outline. To see artwork again, right-click and choose Preview.

Edit artboards

You can create multiple artboards for your document, but only one can be active at a time. When you have multiple artboards defined, you can view them all by selecting the Artboard tool. Each artboard is numbered for easy reference. You can edit or delete an artboard at any time, and you can specify different artboards each time you print or export.

1 Select the Artboard tool , click to select an artboard.

2 Do any of the following:

- To resize the artboard, position the pointer on an edge or corner until the cursor changes to a double-sided arrow, and then drag to adjust. Or, specify new Width and Height values in the Control panel.
- To change the orientation of the artboard, click the Portrait or Landscape button in the Control panel.
- To rotate between artboards, press Alt (Windows) or Option (Mac OS) and click an arrow key.
- To view artboards and their contents as outlines, right-click and choose Outline. To see artwork again, right-click and choose Preview.

Move an artboard

1 Select the Artboard tool and click to select an artboard.

2 Do one of the following:

- To move the artboard and its contents, click to select the Move/Copy Artwork With Artboard icon on the Control panel , and then position the pointer in the artboard and drag. Or, specify new X and Y values in the Control panel.
- To move the artboard without its contents, click to deselect the Move/Copy Artwork With Artboard icon on the Control panel, and then position the pointer in the artboard and drag. Or, specify new X and Y values in the Control panel.

Reorder artboards

In the Artboards panel, you can use the Up and Down Arrows at the bottom of the panel to reorder the artboards. However, reordering artboards in the Artboards panel, does not reorder the artboards in the work area.

Rearrange artboards

To fit all artboards in view, you can rearrange artboards using the Grid by Row, Grid by Column, Arrange by Row, and Arrange by Column options.

To rearrange artboards, do the following:

1 Click the Artboards panel menu (flyout menu) and select the Rearrange Artboards option.

2 In the Rearrange Artboards dialog box, select the layout. The options are:

Grid by Row Arranges multiple artboards in the specified number of rows. Specify the number of rows in the Rows box. The default value creates the most square appearance possible with the specified number of artboards.

Grid by Column Arranges multiple artboards in the specified number of columns. Choose the number of columns from the Columns menu. The default value creates the most square appearance possible with the specified number of artboards.

Arrange by Row Arranges all the artboards in a single row.

Arrange by Column Arranges all the artboards in a single column.

Change to Right-to-Left Layout/Change to Left-to-Right Layout Arranges the artboards from left to right or right to left. By default, artboards are arranged from left to right.

Note: If you select the Change to Right-to-Left Layout option, the Grid by Row and Grid Column options change to Right-to-Left Grid by Row and Right-to-Left Grid by Column.

3 Specify the spacing between the artboards. This setting applies to both horizontal and vertical spacing.

4 Select the Move Artwork with Artboard option to move the artwork whenever the artboards location changes.

Additionally, an artboard within an artboard is treated like a crop area and is moved along with the containing artboard.

Customize artboard names

Each artboard can now be given a custom name, when in artboard edit mode.

To assign a custom name to an artboard, do the following:

1 Select the Artboard Tool to edit the artboard.

2 Select the artboard and specify the artboard name in the Name box of the Artboard Control Panel.

Alternatively, you can provide a custom name in the Name field of the Artboard Options dialog box. To open the dialog box, click Artboard Options in the Artboards Panel menu (flyout menu). Click OK to commit the new name for the chosen artboard.

The new artboard name appears on the upper-left side of the artboard. The custom name also shows up in the Artboard Navigation field and drop-down next to document's status area.

If you assign a custom name to artboards, these names are added as suffix to the filename while saving artboard specific files to all formats.

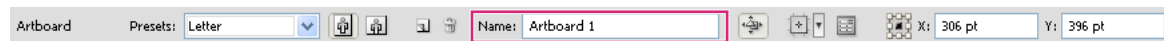

Enter a custom name for an artboard in the Control panel.

Note: To return to the default name, clear the name of the artboard from the Name field in the Control panel.

9-point referencing

To set reference points for artboards, use the Artboard Options dialog box or the Artboard options in the Control panel.

This option allows you to hinge a corner or center of an artboard while its size is being changed.

Display artboard rulers, center mark, crosshairs, or safe area

You can choose to display a center mark, cross hairs, video safe markers, and rulers around an artboard. Rulers are useful when you're working with art intended for export to video. The numbers on the rulers reflect device-specific pixels, regardless of the measurement unit specified in preferences. The default Video Ruler Pixel Aspect Ratio (VPAR) for Illustrator is 1.0 (for square pixels)—this value changes according to the preset you choose either in the Artboard Options dialog box or the New Document dialog box.

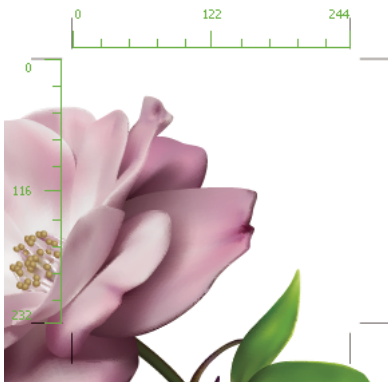

If you're using nonsquare pixels, the ruler provides for easier device-specific pixel calculations. For example, if you specify an artboard of 100 x100 Illustrator points, and you want to know the exact size in device-dependent pixels before exporting the file for use in a NTSC DV Widescreen, you can set the video ruler in Illustrator to use a video ruler pixel aspect ratio of 1.2 (for wide pixels) and the ruler will reflect the change and display the artboard as 83 x100 device pixels ($100/1.2 = 83.333$).



Artboard with rulers

Display center mark, cross hairs, or video safe areas

The center mark, cross hairs, and video safe area are video properties that assist you in creating videos while using Creative Suite products. To display these properties:

- 1 Double-click the Artboard tool  in the Tools panel, or, with the Artboard tool active, click the Artboard Options icon  in the Control panel.
- 2 In the Display section, select the options you'd like displayed in your artboards.

Note: You can also set or remove the center point by clicking the Show Center Mark icon  in the Control panel.

Viewing artwork

Specify Document Setup options

At any point you can change your document's default setup options for units of measure, transparency grid display, background color, and type settings such as language, quote style, superscript and subscript size, bleeds, and exportability. The Edit Artboards button closes this dialog box and activates the Artboard tool.

- 1 Choose File > Document Setup, or click the Document Setup button in the Control panel. (This button is available when nothing is selected.)
- 2 Specify options as desired.

- 3 If you want to edit artboards (for instance, to change from portrait to landscape orientation), click Edit Artboards to enter artboard editing mode.

 *The Simulate Colored Paper option is useful if you plan to print the document on colored paper. For example, if you draw a blue object on a yellow background, the object appears green. The simulation is only performed when the transparency grid is not shown.*

More Help topics

- “[Edit artboards](#)” on page 35
- “[Change the unit of measurement](#)” on page 43
- “[View transparency in artwork](#)” on page 181
- “[Specify curly or straight quotes](#)” on page 326
- “[Creating superscripts or subscripts](#)” on page 326

About print tiling

By default, Illustrator prints each artboard on a single sheet of paper. However, if the artwork is larger than the page sizes available on your printer, you can print onto multiple sheets of paper.

Dividing an artboard to fit a printer’s available page sizes is called *tiling*. You can choose a tiling option in the General section of the Print dialog box. To view the print tiling boundaries on the artboard, choose View > Show Print Tiling.

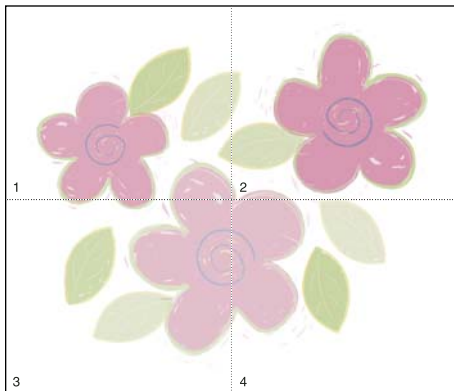

Artboard divided into multiple page tiles

When you divide the artboard into multiple tiles, the pages are numbered from left to right and from top to bottom, starting with page 1. These page numbers appear on-screen for your reference only; they do not print. The numbers enable you to print all of the pages in the file or specify particular pages to print.

More Help topics

- “[Change the page size and orientation](#)” on page 417
- “[Tile artwork on multiple pages](#)” on page 416

Zoom in or out

There are several ways to zoom in or out of artwork.

- Select the Zoom tool . The pointer becomes a magnifying glass with a plus sign in its center. Click in the center of the area that you want to magnify, or hold down Alt (Windows) or Option (Mac OS) and click in the center of the area that you want to reduce. Each click magnifies or reduces the view to the previous preset percentage.
- Select the Zoom tool and drag a dotted rectangle, called a *marquee*, around the area you want to magnify. To move the marquee around the artwork, hold down the spacebar, and continue dragging to move the marquee to a new location.
- Choose View > Zoom In or View > Zoom Out. Each click magnifies or reduces the view to the next preset percentage.
- Set the zoom level at the lower-left corner of the main window or in the Navigator panel.
- To display a file at 100%, choose View > Actual Size, or double-click the Zoom tool.
- To fill the window with the selected artboard, choose View > Fit Artboard In Window, or double-click the Hand tool.
- To view everything in the window, choose View > Fit All In Window.

More Help topics

[“Moving and zooming tool gallery”](#) on page 25

[“Keys for viewing artwork”](#) on page 475

Change the view area

You can bring a different area of the artboard into view by doing any of the following:

- Choose View > Actual Size to see all of your artboards in actual size.
- Choose View > Fit All In Window to zoom out so that all artboards are visible in on the screen.
- Choose View > Fit Artboard In Window to zoom in on the active artboard.
- In the Navigator panel, click the area of the thumbnail display that you want to view in the illustration window. Alternatively, drag the proxy view area (the colored box) to a different area of the thumbnail display.
- Select the Hand tool , and drag in the direction you want the artwork to move.

More Help topics

[“Moving and zooming tool gallery”](#) on page 25

[“Keys for viewing artwork”](#) on page 475

Navigator panel overview

You use the Navigator panel (Window > Navigator) to quickly change the view of your artwork using a thumbnail display. The colored box in the Navigator (called the *proxy view area*) corresponds to the currently viewable area in the illustration window.

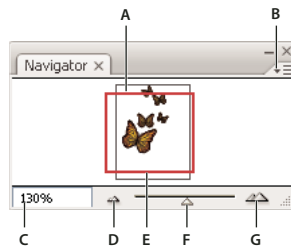

Navigator panel

A. Thumbnail display of artwork B. Panel menu button C. Zoom box D. Zoom Out button E. Proxy preview area F. Zoom slider G. Zoom In button

You can customize the Navigator panel in the following ways:

- To display artwork outside the boundaries of the artboard in the Navigator panel, click View Artboard Contents Only from the panel menu to deselect it.
- To change the color of the proxy view area, select panel Options from the panel menu. Select a preset color from the Color menu, or double-click the color box to choose a custom color.
- To display dashed lines in the document as solid lines in the Navigator panel, select panel Options from the panel menu and select Draw Dashed Lines As Solid Lines.



More Help topics

[“Manage windows and panels”](#) on page 9

View artwork as outlines

By default, Adobe Illustrator sets the view so that all artwork is previewed in color. However, you can choose to display artwork so that only its outlines (or *paths*) are visible. Viewing artwork without paint attributes speeds up the time it takes to redraw the screen when working with complex artwork.

In Outline mode, linked files are displayed by default as outlined boxes with an X inside. To view the contents of linked files, choose File > Document Setup, and select Show Images In Outline Mode.

- To view all artwork as outlines, choose View > Outline. Choose View > Preview to return to previewing artwork in color.
- To view all artwork in a layer as outlines, Ctrl-click (Windows) or Command-click (Mac OS) the eye icon for the layer in the Layers panel. Ctrl-click (Windows) or Command-click (Mac OS) again to return to previewing artwork in color. The eye icon has a hollow center  when Outline view is enabled and a filled center  when Preview view is enabled.
- To view all items in unselected layers as outlines, Alt+Ctrl-click (Windows) or Option+Command-click (Mac OS) the eye icon for the selected layer. Alternatively, select Outline Others from the Layers panel menu.



You can return all items in the Layers panel to Preview mode by choosing Preview All Layers from the Layers panel menu.

More Help topics

[“Layers panel overview”](#) on page 220

Use multiple windows and views

You can open multiple windows of a single document at the same time. Each window can have different view settings. For example, you can set one window highly magnified for doing close-up work on some objects and create another window less magnified for laying out those objects on the page.

 (Windows) You can arrange multiple open windows to suit your needs, using options from the Window menu. Cascade displays windows stacked and descending from the upper-left to the lower-right of the screen; Tile displays windows edge to edge; Arrange Icons organizes minimized windows within the program window.

An alternative to creating multiple windows is creating multiple views. You can create and store up to 25 views for each document.

Multiple windows and multiple views differ in the following ways:

- Multiple views are saved with the document, multiple windows are not.
- Multiple windows can be viewed at the same time.
- Multiple views can appear at the same time only if multiple windows are opened to display them in. Changing a view alters the current windows, it does not open a new one.

Create a new window

- ❖ Choose Window > New Window.

Create a new view

- ❖ Set up the view as you want, and then choose View > New View, enter a name for the new view, and click OK.

Rename or delete a view

- ❖ Choose View > Edit Views.

Switch between views

- ❖ Select a view name from the bottom of the View menu.

Previewing artwork in its final output medium

Illustrator provides the following ways to preview how aspects of artwork will look when printed or viewed on the web or a mobile device:

Overprint Preview mode (View > Overprint Preview) Provides an “ink preview” that approximates how blending, transparency, and overprinting will appear in color-separated output.

Separations Preview mode (Window > Separations Preview) Provides a preview of how the separations will look when printed.

Pixel Preview mode (View > Pixel Preview) Approximates how your artwork will appear when it is rasterized and viewed in a web browser.

Flattener Preview panel (Window > Flattener Preview) Highlights areas of the artwork that meet certain criteria for *flattening* when saved or printed.

Soft-proofs Approximate how your document’s colors will appear on a particular type of monitor or output device.

Anti-aliasing Gives vector objects a smoother on-screen appearance and provides a better idea of how vector artwork will look when printed on a PostScript® printer. Anti-aliasing is helpful because screen resolution is relatively limited,

but vector artwork is often printed at a high resolution. To turn on anti-aliasing, choose Edit > Preferences > General (Windows) or Illustrator > Preferences > General (Mac OS), select Anti-aliased Artwork, and click OK.

Device Central (File > Device Central) Lets you preview how your document will appear on a particular mobile phone or device.

More Help topics

[“About overprinting”](#) on page 438

[“About pixel preview mode”](#) on page 385

[“Using Adobe Device Central with Illustrator”](#) on page 386

[“Preview which areas of artwork will be flattened”](#) on page 435

Rulers, grids, guides, and crop marks

Use rulers

Rulers help you accurately place and measure objects in the illustration window or in an artboard. The point where 0 appears on each ruler is called the *ruler origin*.

In Illustrator CS5, rulers are similar to other Creative Suite applications like InDesign and Photoshop. Illustrator provides separate rulers for documents and artboards. You can select only one of these rulers at one point.

Note: Window rulers would be called Global rulers in this document.

Global rulers appear at the top and left sides of the illustration window. The default ruler origin is located at the top-left corner of the illustration window.

Artboard rulers appear at the top and left sides of the active artboard. The default artboard ruler origin is located at the top-left corner of the artboard.

The difference between artboard rulers and global rulers is that if you select artboard rulers, the origin point changes based on the active artboard. In addition, you can have different origin points for artboard rulers. Now, if you change the artboard ruler origin, the pattern fills in objects on the artboards are not affected.

The default origin point for the global ruler is at the upper-left corner of the first artboard and the default origin for the artboard rulers is at the top left corner of the respective artboard.

- To show or hide rulers, choose View > Rulers > Show Rulers or View > Rulers > Hide Rulers.
- To toggle between artboard rulers and global rulers, click the View > Rulers > Change to Global Rulers or View > Rulers > Change to Artboard Rulers. By default, artboard rulers are displayed, so Change to Global Rulers option is displayed under Rulers sub-menu.
- To show or hide video rulers, choose View > Show Video Rulers or View > Hide Video Rulers.
- To change the ruler origin, move the pointer to the upper-left corner where the rulers intersect, and drag the pointer to where you want the new ruler origin.

As you drag, a cross hair in the window and in the rulers indicates the changing Global ruler origin.

Note: Changing the Global ruler origin affects the tiling of patterns.

- To restore the default ruler origin, double-click the upper-left corner where the rulers intersect.

The coordinate system has now been switched to fourth quadrant, which was previously the first quadrant. In Illustrator CS5, when you move downwards, the value of y-axis increases and if you move toward right, the value of x-axis increases.

For saving to legacy versions of Illustrator, the Global rulers remain at the position set in legacy document. Although, the origin point does not move to upper left, the coordinate system changes to fourth quadrant.

The change in coordinate system and the ruler origin does not apply to scripting, which allows you to retain old scripts. However, when you transform objects using scripting, the Y coordinate values differ from the values that you set in the Illustrator user interface. For example, if you apply a move operation of say Y= +10 points, then to emulate the same movement with scripting, apply a transformation of Y = -10pts.

Change the unit of measurement

The default unit of measurement in Illustrator is points (a point equals .3528 millimeter). You can change the unit that Illustrator uses for general measurements, strokes, and type. You can override the default unit while entering values in boxes.

- To change the default unit of measurement, choose Edit > Preferences > Units (Windows) or Illustrator > Preferences > Units (Mac OS), and then select units for the General, Stroke, and Type options. If Show Asian Options is selected in the Type preferences, you can also select a unit specifically for Asian type.

Note: The “General” measurement option affects rulers, measuring the distance between points, moving and transforming objects, setting grid and guides spacing, and creating shapes.

- To set the general unit of measurement for the current document only, choose File > Document Setup, choose the unit of measure you want to use from the Units menu, and click OK.
- To change the unit of measurement when entering a value in a box, follow the value by any of the following abbreviations: inch, inches, in, millimeters, millimetres, mm, Qs (one Q equals 0.25 millimeter), centimeters, centimetres, cm, points, p, pt, picas, pc, pixel, pixels, and px.

 When mixing picas and points, you can enter values as XpY, where X and Y are the number of picas and points (for example, 12p6 for 12 picas, 6 points).

Use the grid

The grid appears behind your artwork in the illustration window, and it does not print.

- To use the grid, choose View > Show Grid.
- To hide the grid, choose View > Hide Grid.
- To snap objects to gridlines, choose View > Snap To Grid, select the object you want to move, and drag it to the desired location.

When the object’s boundaries come within 2 pixels of a gridline, it snaps to the point.

Note: When the View > Pixel Preview option is selected, Snap To Grid changes to Snap To Pixel.

- To specify the spacing between gridlines, grid style (lines or dots), grid color, or whether grids appear in the front or back of artwork, choose Edit > Preferences > Guides & Grid (Windows) or Illustrator > Preferences > Guides & Grid (Mac OS).

Use guides

Guides help you align text and graphic objects. You can create *ruler guides* (straight vertical or horizontal lines) and *guide objects* (vector objects that you convert to guides). Like the grid, guides do not print.

You can choose between two guide styles—dots and lines—and you can change the color of guides by using either predefined guide colors or colors you select using a color picker. By default, guides are unlocked so that you can move, modify, delete, or revert them, but you can choose to lock them into place.

- To show or hide guides, choose View > Guides > Show Guides or View > Guides > Hide Guides.
- To change guide settings, choose Edit > Preferences > Guides & Grid (Windows) or Illustrator > Preferences > Guides & Grid (Mac OS).
- To lock guides, select View > Guides > Lock Guides.

Create guides

- 1 If the rulers aren't showing, choose View > Show Rulers.
- 2 Position the pointer on the left ruler for a vertical guide or on the top ruler for a horizontal guide.
- 3 Drag the guide into position.

You can also convert vector objects to guides by selecting them and choosing View > Guides > Make Guides.



To make working with multiple guides easier, move them into a separate layer.

- 4 If you want to restrict the guides to an artboard and not to the entire canvas, then select the Artboard tool and then drag the guides on to the artboard.

Move, delete, or release guides

- 1 If guides are locked, select View > Guides > Lock Guides.
- 2 Do any of the following:
 - Move the guide by dragging or copying.
 - Delete the guide by pressing Backspace (Windows) or Delete (Mac OS), or by choosing Edit > Cut or Edit > Clear.
 - Delete all guides at once by choosing View > Guides > Clear Guides.
 - Release the guide, turning it back into a regular graphic object, by selecting the guide and choosing View > Guides > Release Guides.

Snap objects to anchor points and guides

- 1 Choose View > Snap To Point.
- 2 Select the object you want to move, and position the pointer on the exact point you want to align with anchor points and guides.

Important: *When snapping to a point, the snapping alignment depends on the position of the pointer, not the edges of the dragged object.*

- 3 Drag the object to the desired location.

When the pointer comes within 2 pixels of an anchor point or guide, it snaps to the point. The pointer changes from a filled arrowhead to a hollow arrowhead when a snap occurs.

Smart Guides

Smart Guides are temporary snap-to guides that appear when you create or manipulate objects or artboards. They help you align, edit, and transform objects or artboards relative to other objects, artboards, or both by snap-aligning and displaying X, Y location and delta values. You can specify the type of smart guides and feedback that appear (such as measurement labels, object highlighting, or labels) by setting the Smart Guides preferences.

To see a video on using smart guides, see www.adobe.com/go/lrvid4020_ai.

Use Smart Guides

Smart Guides are on by default.

- 1 Choose View > Smart Guides to turn guides on or off.
- 2 Use Smart Guides in the following ways:
 - When you create an object with the pen or shape tools, use the Smart Guides to position a new object's anchor points relative to an existing object. Or, when you create a new artboard, use Smart Guides to position it relative to another artboard or an object.
 - When you create an object with the pen or shape tools, or when you transform an object, use the smart guides' construction guides to position anchor points to specific preset angles, such as 45 or 90 degrees. You set these angles in the Smart Guides preferences.
 - When you move an object or artboard, use the Smart Guides to align the selected object or artboard to other objects or artboards. The alignment is based on the geometry of objects and artboards. Guides appear as the object approaches the edge or center point of other objects.

Note: Press *Ctrl* (Windows) or *Command* (Mac OS) to use the alignment behavior from Illustrator CS3, which uses the center point or edge of one object or artboard.

- When you transform an object, Smart Guides automatically appear to assist the transformation.

You can change when and how Smart Guides appear by setting Smart Guide preferences.

Note: When *Snap To Grid* or *Pixel Preview* is turned on, you cannot use Smart Guides (even if the menu command is selected).

Smart Guide preferences

Choose Edit > Preferences > Smart Guides (Windows) or Illustrator > Preferences > Smart Guides (Mac OS) to set the following preferences:

Color Specifies the color of the guides.

Alignment Guides Displays guide lines that are generated along the center and edges of geometric objects, artboard, and bleeds. They are generated when you move objects and when you perform operations such as drawing basic shapes, using Pen tool, and transforming objects.

Anchor/Path Labels Displays information when paths intersect and when they are centered on an anchor point.

Measurement Labels Displays information for many tools (such as Drawing tools and Text tools) about the current position the cursor as you position the cursor over an anchor point. While creating, selecting, moving, or transforming objects it displays the x and y delta from the object's original location. When you press Shift while using a drawing tool, the starting location appears.

Object Highlighting Highlights the object below the pointer as you drag around it. The highlight color matches the object's layer color.

Transform Tools Displays information when you scale, rotate, and shear objects.

Construction Guides Displays guidelines as you draw new objects. You specify the angles at which you want guidelines drawn from the anchor points of a nearby object. You can set up to six angles. Type an angle in the selected Angles box, select a set of angles from the Angles pop-up menu, or select a set of angles from the pop-up menu and change one of the values in the box to customize a set of angles. The preview reflects your settings.

Snapping Tolerance Specifies the number of points the pointer must be from another object for Smart Guides to take effect.

Specify crop marks for trimming or aligning

In addition to specifying different artboards to crop artwork for output, you can also create and use multiple sets of *crop marks* within your artwork. Crop marks indicate where you want the printed paper to be cut. Crop marks are useful when you want to create marks around several objects on a page—for example, when printing a sheet of business cards. They are also helpful for aligning Illustrator artwork that you’ve exported to another application.

Crop marks differ from the artboard in the following ways:

- Artboards specify the printable boundaries of artwork, whereas crop marks don’t affect the printed area at all.
- You can activate only one artboard at a time, whereas you can create and display multiple crop marks.
- The artboard is indicated by visible but non-printing marks, whereas crop marks are printed with registration black (so that they print to every separation plate, similar to printer’s marks).

Note: Crop marks do not replace trim marks created with the *Marks & Bleed* options in the *Print* dialog box.

Create crop marks around an object

In Illustrator CS5, you can create editable trim/crop marks or create crop marks as live effects.

To use crop marks, do the following:

- 1 Select the object.
- 2 To create editable trim marks or crop marks, select **Object > Create Trim Marks**.
- 3 To create crop marks as live effect, select **Effect > Crop Marks**.

Delete crop marks

To delete an editable crop or trim marks, select the trim marks and press the Delete key.

To delete a crop marks effect, select **Crop Marks** in the **Appearance** panel, and click the **Delete Selected Item** icon .

Use Japanese-style crop marks

Japanese-style crop marks have double lines, which visually define a default bleed value of 8.5 points (3 millimeters).

- 1 Choose **Edit > Preferences > General (Windows)** or **Illustrator > Preferences > General (Mac OS)**.
- 2 Select **Use Japanese Crop Marks**, and then click **OK**.

Measure the distance between objects

The Measure tool calculates the distance between any two points and displays the results in the Info panel.





- 1 Select the Measure tool . (Press and hold the Eyedropper tool to see it in the Tools panel.)
- 2 Do one of the following:
 - Click the two points to measure the distance between them.

- Click the first point and drag to the second point. Shift-drag to constrain the tool to multiples of 45°.

The Info panel shows the horizontal and vertical distances from the x and y axes, the absolute horizontal and vertical distances, the total distances, and the angle measured.

Info panel overview

You use the Info panel (Window > Info) to get information on the area beneath the pointer and on selected objects.

- When an object is selected and a selection tool is active, the Info panel displays the object's x and y coordinates, width (W), and height (H). The values for width and height are affected by the Use Preview Bounds option in the General preferences. When Use Preview Bounds is selected, Illustrator includes the stroke width (and other attributes such as drop shadows) in the object's dimensions. When Use Preview Bounds is deselected, Illustrator measures only the dimensions defined by the object's vector path.
- When you use the Pen tool or Gradient tool, or when you move a selection, the Info panel displays the change in x (W), the change in y (H), the distance (D), and the angle  as you drag.
- When you use the Zoom tool, the Info panel displays the magnification factor and the x and y coordinates after you release the mouse button.
- When you use the Scale tool, the Info panel displays the percentage change in width (W) and height (H) and the new width (W) and height (H) after the scaling is complete. When you use the rotate or reflect tools, the Info panel displays the coordinates of the object's center and the angle of rotation  or reflection .
- When you use the Shear tool, the Info panel displays the coordinates of the object's center, the angle of shear axis , and the amount of shear .
- When you use the Paintbrush tool, the Info panel displays the x and y coordinates and the name of the current brush.
- Select Show Options from the panel menu or click the double arrow on the panel tab to show values for the fill and stroke colors of the selected object and the name of any pattern, gradient, or tint applied to the selected object.

Note: If you select multiple objects, the Info panel displays only the information that is the same for all selected objects.

Setting preferences

About preferences

Preferences are options regarding how you want Illustrator to work, including those for display, tools, ruler units, and exporting information. Your preferences are saved in a file called AIPrefs (Windows) or Adobe Illustrator Prefs (Mac OS), which is launched each time you start Illustrator.

Open a preferences dialog box

- 1 Do one of the following:
 - (Windows) Choose Edit > Preferences > [preference set name].
 - (Mac OS) Choose Illustrator > Preferences > [preference set name].
 - With nothing selected, click the Preferences button on the Control panel.
- 2 To switch to a different preference set, do one of the following:
 - Select an option from the menu at the upper-left of the Preferences dialog box.

- Click Next to display the next options, or click Prev to display the previous options.

Reset all preferences to default settings

Resetting preferences can be helpful if you are having problems with the application.

❖ Do one of the following:

- Press and hold Alt+Control+Shift (Windows) or Option+Command+Shift (Mac OS) as you start Illustrator. Your current settings are deleted.
- Remove or rename the AIPrefs file (Windows) or Adobe Illustrator Prefs file (Mac OS). New preferences files are created the next time you start Illustrator.

Note: *It is safe to remove the entire Adobe Illustrator CS5 Settings folder. This folder contains various preferences that can be regenerated.*

Setting Illustrator preferences

The Illustrator preferences file manages the commands and panel settings in Illustrator. When you open Illustrator, the positioning of panels and commands are stored in the Illustrator preferences file. If you want to restore the default settings for Illustrator or change the current settings, delete the Illustrator preferences. Illustrator automatically creates a preference file, when you restart Illustrator and save a file.

Depending on the operating system that you are using, the Illustrator preferences file is available at the following location:

Note: *The folder name may vary depending on the language version you have installed.*

Mac OS X

```
<startup drive>/Users/<username>/Library/Preferences/Adobe Illustrator CS5  
Settings/en_US*/Adobe Illustrator Prefs
```

Windows XP

```
<startup drive>\ Documents and Settings\<username>\Application Data\Adobe\Adobe Illustrator  
CS5 Settings\en_US*\AIPrefs
```

Windows Vista or Windows 7

```
<startup drive>\Users\<username>\AppData\Roaming\Adobe\Adobe Illustrator CS5  
Settings\en_US*\AIPrefs.
```

Note: *In Windows XP, the Application Data folder is hidden by default. The same is true for the AppData folder in Windows Vista and Windows 7. To make this folder visible, open Folder Options in Control Panel and click the View tab. In the Advanced Settings pane, select the Show Hidden Files and Folders or Show hidden files, folders, or drives option.*

 *If you cannot locate the preferences file, use your operating system's Find command, and search for AIPrefs (Windows) or Adobe Illustrator Prefs (Mac OS).*

About plug-in modules

Plug-in modules are software programs that add features to Adobe Illustrator. A number of special effects plug-ins come with your program and are automatically installed in the Plug-ins folder inside the Illustrator folder.

You can install any commercial plug-in designed for use with Photoshop or Illustrator. To install an Adobe Systems plug-in module, use the installer if one is provided. Otherwise, drag a copy of the module to the Plug-ins folder inside the Illustrator folder. Then restart Illustrator for the plug-in to take effect. To install a third-party plug-in module, follow the installation instructions that came with the plug-in module.

Note: The open architecture of the Adobe Illustrator program allows developers outside of Adobe to create features that are accessible from within Adobe Illustrator. If you are interested in creating plug-in modules compatible with Adobe Illustrator, see the Adobe Systems U.S. website at www.adobe.com.

Recovery, undo, and automation

Undo and redo changes

The Undo and Redo commands let you undo or redo operations, allowing you to correct mistakes as you work. You can undo or redo an operation after you select the Save command (but not if you have closed and then reopened the file).

❖ Choose Edit > Undo or Edit > Redo.

You can undo an unlimited number of operations (depending on memory) by repeatedly choosing the Undo command. If an operation cannot be undone, the Undo command is dimmed.

Revert to the last saved version

You can revert a file to the last saved version (but not if you have closed and then reopened the file). You cannot undo this action.

❖ Choose File > Revert.

Automating tasks

Graphic design is a field characterized by creativity, but there are some aspects of the actual work of illustration that can be repetitious. In fact, you'll probably notice that the time you spend placing and replacing images, correcting errors, and preparing files for printing and web display often reduces the time you have available for doing creative work.

Illustrator provides a variety of ways to automate many of the repetitive tasks you have to do, leaving more time to concentrate on the creative aspects of your work.

An *action* is a series of tasks that are recorded while using the Illustrator application—menu commands, tool options, object selection, and so on. When you play an action, Illustrator performs all of the recorded tasks for you.

Illustrator provides prerecorded actions to assist you in performing common tasks. These actions are installed as a default set in the Actions panel when you install the Illustrator application.

A *script* is a series of commands that tells your computer to perform a sequence of operations. These operations may involve only Illustrator, or they may involve other applications, such as word-processing, spreadsheet, and database-management programs. Illustrator provides default scripts to assist you in performing common tasks. You can access these scripts by choosing File > Scripts.

Data-driven graphics streamline how designers and developers work together in high-volume publishing environments.

Chapter 3: Drawing

Drawing basics

You draw and modify paths using a set of drawing tools and techniques common to Adobe Illustrator, Adobe® InDesign®, and Adobe® Photoshop®. Use these applications to draw paths, and freely copy and paste them between programs. You can also create symbols for use in both Adobe Illustrator and Adobe® Flash® Professional.

About vector graphics

Vector graphics (sometimes called *vector shapes* or *vector objects*) are made up of lines and curves defined by mathematical objects called *vectors*, which describe an image according to its geometric characteristics.

You can freely move or modify vector graphics without losing detail or clarity, because they are resolution-independent—they maintain crisp edges when resized, printed to a PostScript printer, saved in a PDF file, or imported into a vector-based graphics application. As a result, vector graphics are the best choice for artwork, such as logos, that will be used at various sizes and in various output media.

The vector objects you create using the drawing and shape tools in Adobe Creative Suite are examples of vector graphics. You can use the Copy and Paste commands to duplicate vector graphics between Creative Suite components.

More Help topics

[“About bitmap images”](#) on page 271

About paths

As you draw, you create a line called a *path*. A path is made up of one or more straight or curved *segments*. The beginning and end of each segment are marked by *anchor points*, which work like pins holding a wire in place. A path can be *closed* (for example, a circle), or *open*, with distinct *endpoints* (for example, a wavy line).

You change the shape of a path by dragging its anchor points, the *direction points* at the end of *direction lines* that appear at anchor points, or the path segment itself.

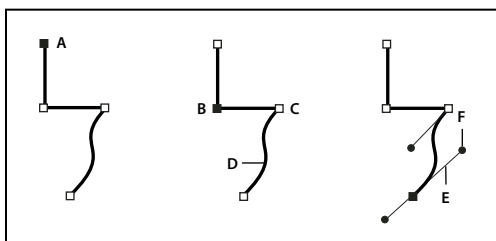

Components of a path

A. Selected (solid) endpoint B. Selected anchor point C. Unselected anchor point D. Curved path segment E. Direction line F. Direction point

Paths can have two kinds of anchor points: corner points and smooth points. At a *corner point*, a path abruptly changes direction. At a *smooth point*, path segments are connected as a continuous curve. You can draw a path using any combination of corner and smooth points. If you draw the wrong kind of point, you can always change it.

Drawing

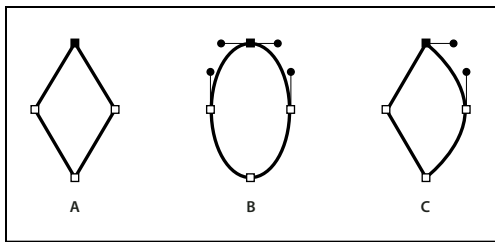

Points on a path

A. Four corner points B. Four smooth points C. Combination of corner and smooth points

A corner point can connect any two straight or curved segments, while a smooth point always connects two curved segments.

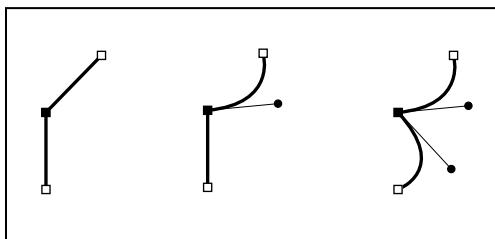

A corner point can connect both straight segments and curved segments.

Note: Don't confuse corner and smooth points with straight and curved segments.

A path's outline is called a *stroke*. A color or gradient applied to an open or closed path's interior area is called a *fill*. A stroke can have weight (thickness), color, and a dash pattern (Illustrator and InDesign) or a stylized line pattern (InDesign). After you create a path or shape, you can change the characteristics of its stroke and fill.

In InDesign, each path also displays a *center point*, which marks the center of the shape but is not part of the actual path. You can use this point to drag the path, to align the path with other elements, or to select all anchor points on the path. The center point is always visible; it can't be hidden or deleted.

About direction lines and direction points

When you select an anchor point that connects curved segments (or select the segment itself), the anchor points of the connecting segments display *direction handles*, which consist of *direction lines* that end in *direction points*. The angle and length of the direction lines determine the shape and size of the curved segments. Moving the direction points reshapes the curves. Direction lines don't appear in the final output.

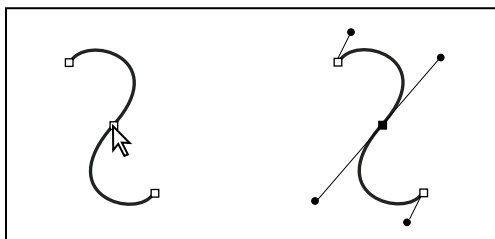

After selecting an anchor point (left), direction lines appear on any curved segments connected by the anchor point (right).

A smooth point always has two direction lines, which move together as a single, straight unit. When you move a direction line on a smooth point, the curved segments on both sides of the point are adjusted simultaneously, maintaining a continuous curve at that anchor point.

In comparison, a corner point can have two, one, or no direction lines, depending on whether it joins two, one, or no curved segments, respectively. Corner point direction lines maintain the corner by using different angles. When you move a direction line on a corner point, only the curve on the same side of the point as that direction line is adjusted.

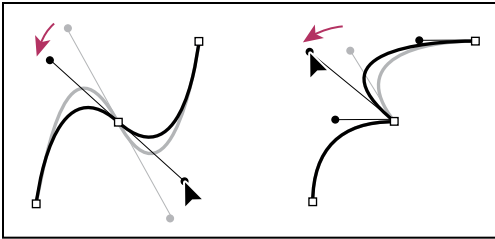

Adjusting direction lines on a smooth point (left) and a corner point (right)

Direction lines are always tangent to (perpendicular to the radius of) the curve at the anchor points. The angle of each direction line determines the slope of the curve, and the length of each direction line determines the height, or depth, of the curve.

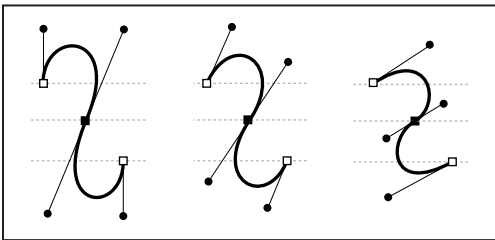

Moving and resizing direction lines changes the slope of curves.

Note: In Illustrator, you can show or hide anchor points, direction lines, and direction points by choosing *View > Show Edges* or *View > Hide Edges*.

Specify direction line and direction point appearance

When working with anchor points and paths, you may sometimes need to see direction lines (handles), while at other times they may get in the way. You can show or hide direction lines for multiple selected anchor points. For a single anchor point, the lines always appear.

You can choose to show or hide direction lines on a per-selection basis, or you can set a preference for direction line display.

For a video on setting direction lines and points, see www.adobe.com/go/vid0037.

More Help topics

“Specify selection preferences” on page 202

Show or hide direction lines for selected anchor points

- 1 Use the Direct Selection tool to select the desired anchor points.



- In the Control panel, click Show Handles For Multiple Selected Anchor Points  > or Hide Handles For Multiple Selected Anchor Points  .

Note: You can also set a preference to always show or always hide handles when multiple anchor points are selected.

Set direction point and direction line display preferences

- Choose Edit > Preferences > Selection & Anchor Display (Windows) or Illustrator > Preferences > Selection & Anchor Display (Mac OS).
- In the Anchor Point And Handle Display area, specify any of the following:

Handles Specifies the display of handle end points (direction points):



-  Displays direction points as small solid circles.
-  Displays direction points as large solid circles.
-  Displays direction points as open crosses.

Show Handles When Multiple Anchors Are Selected Displays direction lines on all selected anchor points when you use the Direct Selection tool or Group Selection tool to select an object. If you don't select this option, direction lines are displayed for an anchor point if it is the only anchor point selected on that path, or if the Bezier segment for the direction line is selected and the anchor point from which the direction line extends is not selected.

Specify anchor point size preferences

- Choose Edit > Preferences > Selection & Anchor Display (Windows) or Illustrator > Preferences > Selection & Anchor Display (Mac OS).
- In the Anchor Point And Handle Display area, specify any of the following:



Anchors Specifies the display of anchor points:

-  Displays both selected and unselected anchor points as small points.
-  Displays selected anchor points as large points and unselected anchor points as small points.
-  Displays both selected and unselected anchor points as large points.

Highlight Anchors On Mouse Over Highlights the anchor point located directly below the mouse cursor.

Drawing modes

Illustrator CS5 provides the following drawing modes:

- Draw Normal ()
- Draw Behind ()
- Draw Inside ()

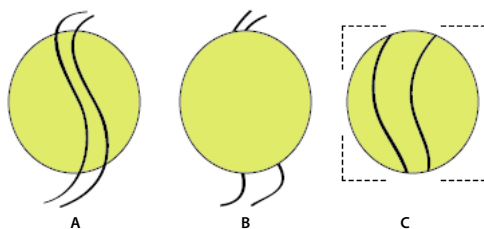

A dotted open rectangle like the one shown in the illustration C, is displayed when an object with Draw Inside mode is active.

The Draw Normal mode is the default drawing mode. You can select drawing modes from the Tools panel, below the Color Selector tool.



Drawing Modes panel

To switch through drawing modes, click the Drawing Modes panel in the Tools panel and select the drawing mode. You can also use the Shift+D keyboard shortcut to cycle through the drawing modes.

Note: *The options, Paste, Paste in Place, and Paste on All Artboards honor the drawing modes. However, Paste in Front and Paste in Back commands are not affected by the drawing modes.*

For a video on using the different drawing modes, see www.adobe.com/go/lrvid5209_ai_en.

Draw Behind mode

The Draw Behind mode allows you to draw behind all artwork on a selected layer if no artwork is selected. If an artwork is selected, the new object is drawn directly beneath the selected object.

The draw behind mode is honored in the following cases:

- Creating new layers
- Placing symbols
- Placing files from the File menu
- Using Alt+Drag to duplicate objects
- Using Paste in Place and Paste on All Artboards options

Draw Inside mode

The Draw Inside mode allows you to draw inside the selected object. The Draw Inside mode eliminates the need to perform multiple tasks such as drawing and altering stacking order or drawing, selecting, and creating a clipping mask.

The draw inside mode is enabled only when there is a single selected object (path, compound path, or text).

To create clipping masks using the Draw Inside mode, select the path within which you want to draw and switch to the Draw Inside mode. Subsequent paths are clipped by the path that was selected when you switch to the Draw Inside mode, until you switch to the Draw Normal mode (Shift+D or double-click).

Note: *The clipping masks created using Draw Inside retain the appearance on the clipping path unlike the menu command Object > Clipping Mask > Make.*

Drawing simple lines and shapes

Draw straight lines with the Line Segment tool

Use the Line Segment tool when you want to draw one straight line segment at a time. For a video on using the Line Segment tool, see www.adobe.com/go/vid0036.

- 1 Select the Line Segment tool .
- 2 Do one of the following:
 - Position the pointer where you want the line to begin, and drag to where you want the line to end.



- Click where you want the line to begin, and specify the length and angle of the line. If you want to fill the line with the current fill color, select Fill Line. Then click OK.

More Help topics

“[Drawing tool gallery](#)” on page 18

“[Keys for drawing](#)” on page 476

Draw rectangles and squares

- 1 Select the Rectangle tool  or the Rounded Rectangle tool .
- 2 Do one of the following:
 - To draw a rectangle, drag diagonally until the rectangle is the desired size.
 - To draw a square, hold down the Shift key while you drag diagonally until the square is the desired size.
 - To create a square or rectangle using values, click where you want the top-left corner to be. Specify a width and height (and a corner radius for a rounded rectangle), and click OK.

For a video on using shape tools, see www.adobe.com/go/vid0036. For an example of using shape tools to draw buildings, see www.adobe.com/go/learn_ai_tutorials_shapes_en.

More Help topics

“[Drawing tool gallery](#)” on page 18

“[Keys for drawing](#)” on page 476

Specify the corner radius of a rounded rectangle

The corner radius determines the roundness of the rectangle’s corners. You can change the default radius for all new rectangles, and you can change the radius for individual rectangles as you draw them.

- To change the default corner radius, choose Edit > Preferences > General (Windows) or Illustrator > Preferences > General (Mac OS), and enter a new value for Corner Radius. Alternatively, select the Rounded Rectangle tool, click in the document window, and enter a new value for Corner Radius. The default radius applies only to new rounded rectangles you draw, not to existing rounded rectangles.
- To change the corner radius while dragging with the Rounded Rectangle tool, press the Up Arrow key or Down Arrow key. When the corners are the desired roundness, release the key.
- To create square corners while dragging with the Rounded Rectangle tool, press the Left Arrow key.
- To create the most rounded corners while dragging with the Rounded Rectangle tool, press the Right Arrow key.

Draw ellipses

- 1 Select the Ellipse tool .
- 2 Do one of the following:
 - Drag diagonally until the ellipse is the desired size.
 - Click where you want the top-left corner of the ellipse’s bounding box to be. Specify a width and height for the ellipse, and click OK.

Note: To create a circle, hold down the Shift key while dragging, or if you are specifying dimensions, once you've entered a Width value you can click on the word Height to copy that value into the Height box.

For a video on using shape tools, see www.adobe.com/go/vid0036.

More Help topics

“Drawing tool gallery” on page 18

“Keys for drawing” on page 476

Draw polygons

1 Select the Polygon tool .

2 Do one of the following:

- Drag until the polygon is the desired size. Drag the pointer in an arc to rotate the polygon. Press the Up Arrow and Down Arrow keys to add and remove sides from the polygon.
- Click where you want the center of the polygon to be. Specify a radius and number of sides for the polygon, and click OK.



Triangles are polygons too! You can draw one just as you would any other polygon.

For a video on using shape tools, see www.adobe.com/go/vid0036.

More Help topics

“Drawing tool gallery” on page 18

“Keys for drawing” on page 476

Draw stars

1 Select the Star tool .

2 Do one of the following:

- Drag until the star is the desired size. Drag the pointer in an arc to rotate the star. Press the Up Arrow and Down Arrow to add and remove points from the star.
- Click where you want the center of the star to be. For Radius 1, specify the distance from the center of the star to the star's innermost points. For Radius 2, specify the distance from the center of the star to the star's outermost points. For Points, specify how many points you want the star to have. Then click OK. To increase or decrease the number of points in the star, you can also use the up and down arrow keys while drawing the star.

For a video on using shape tools, see www.adobe.com/go/vid0036.

More Help topics

“Drawing tool gallery” on page 18

“Keys for drawing” on page 476

Draw arcs

1 Select the Arc tool .

2 Do one of the following:

- Position the pointer where you want the arc to begin, and drag to where you want the arc to end.
- Click where you want the arc to begin. In the dialog box, click a square on the reference point locator  to determine the point from which the arc is drawn. Then set any of the following options, and click OK.

Length X-Axis Specifies the width of the arc.

Length Y-Axis Specifies the height of the arc.

Type Specifies whether you want the object to be an open path or a closed path.

Base Along Specifies the direction of the arc. Choose X Axis or Y Axis depending on whether you want to draw the base of the arc along the horizontal (*x*) axis or vertical (*y*) axis.

Slope Specifies the direction of the arc's slope. Enter a negative value for a concave (inward) slope. Enter a positive value for a convex (outward) slope. A slope of 0 creates a straight line.

Fill Arc Fills the arc with the current fill color.

Note: To see a dynamic preview of the arc as you set options, double-click the arc tool in the Tools panel.

For a video on using shape tools, see www.adobe.com/go/vid0036.

More Help topics

“[Drawing tool gallery](#)” on page 18

“[Keys for drawing](#)” on page 476

Draw spirals

1 Select the Spiral tool .

2 Do one of the following:

- Drag until the spiral is the desired size. Drag the pointer in an arc to rotate the spiral.
- Click where you want the spiral to begin. In the dialog box, set any of the following options, and click OK.

Radius Specifies the distance from the center to the outermost point in the spiral.

Decay Specifies the amount by which each wind of the spiral should decrease relative to the previous wind.

Segments Specifies how many segments the spiral has. Each full wind of the spiral consists of four segments.

Style Specifies the direction of the spiral.

For a video on using shape tools, see www.adobe.com/go/vid0036.

More Help topics

“[Drawing tool gallery](#)” on page 18

“[Keys for drawing](#)” on page 476

Draw grids

Use the grid tools to quickly draw rectangular and polar grids. The Rectangular Grid tool creates rectangular grids of a specified size with a specified number of dividers. The Polar Grid tool creates concentric circles of a specified size and a specified number of dividers.

More Help topics

[“Drawing tool gallery”](#) on page 18

[“Keys for drawing”](#) on page 476

Draw rectangular grids

1 Select the Rectangular Grid tool .

2 Do one of the following:

- Drag until the grid is the desired size.
- Click to set the grid’s reference point. In the dialog box, click a square on the reference point locator  to determine the point from which the grid is drawn. Then set any of the following options, and click OK.

Default Size Specifies the width and height of the entire grid.

Horizontal Dividers Specifies the number of horizontal dividers you want to appear between the top and bottom of the grid. The Skew value determines how the horizontal dividers are weighted toward the top or bottom of the grid.

Vertical Dividers Specifies the number of dividers you want to appear between the left and right sides of the grid. The Skew value determines how the vertical dividers are weighted to the left or right side.

Use Outside Rectangle As Frame Replaces the top, bottom, left, and right segments with a separate rectangular object.

Fill Grid Fills the grid with the current fill color (otherwise, the fill is set to none).

Draw circular (polar) grids

1 Select the Polar Grid tool .

2 Do one of the following:

- Drag until the grid is the desired size.
- Click to set the grid’s reference point. In the dialog box, click a square on the reference point locator  to determine the point from which the grid is drawn. Then set any of the following options, and click OK.

Default Size Specifies the width and height of the entire grid.

Concentric Dividers Specifies the number of circular concentric dividers you want to appear in the grid. The Skew value determines how the concentric dividers are weighted toward the inside or outside of the grid.

Radial Dividers Specifies the number of radial dividers you want to appear between the center and the circumference of the grid. The Skew value determines how the radial dividers are weighted counterclockwise or clockwise on the grid.

Create Compound Path From Ellipses Converts the concentric circles into separate compound paths and fill every other circle.

Fill Grid Fills the grid with the current fill color (otherwise, the fill is set to none).

Drawing pixel-aligned paths for web workflows

Pixel-aligned is an object level property, which enables an object to have its vertical and horizontal paths aligned to the pixel grid. This property remains with the object when the object is modified. Any vertical or horizontal path in the object gets aligned to pixel grid as long as the property is set for it.

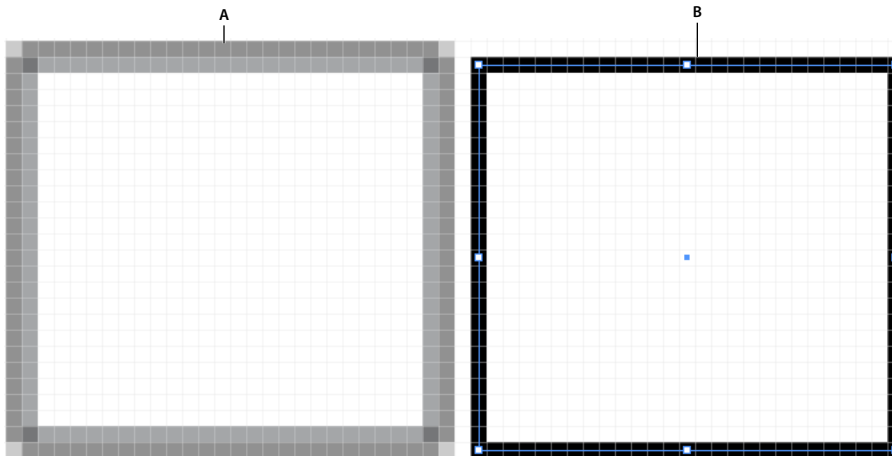

An illustration showing pixel-aligned objects and objects that are not pixel-aligned
A. Object is not pixel-aligned B. Object is pixel-aligned

For a video on drawing pixel-aligned paths for web workflows, see www.adobe.com/go/lrivid5201_ai_en.

Aligning new objects to pixel grid

The Align New Objects to Pixel Grid option is available in the Advanced section of the New Document dialog box.

This option is also available in the Transform panel menu (flyout menu) of the Transform panel.

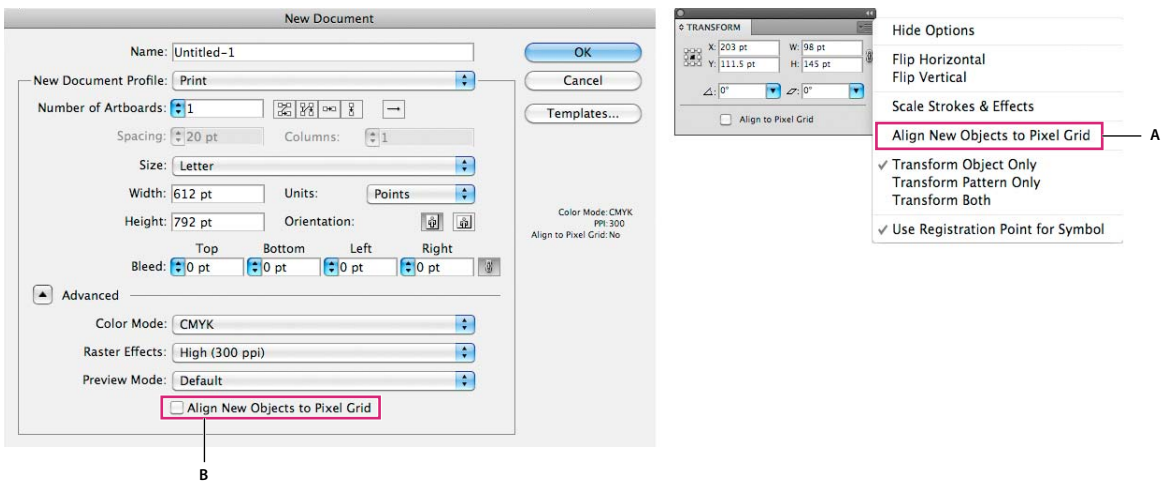

Align New Objects to Pixel Grid option in the Transform panel menu

If you enable this option, any new objects that you draw have the pixel-aligned property set by default. For new documents created using the web document profile, this option is enabled by default.

The crisp appearance of pixel-aligned strokes is maintained in the raster output at a resolution of 72-ppi only. For other resolutions, there is a high possibility of such strokes producing anti-aliased results.

Objects that are pixel-aligned, but do not have any straight vertical or horizontal segments, are not modified to align to the pixel grid. For example, because a rotated rectangle does not have straight vertical or horizontal segments, it is not nudged to produce crisp paths, when the pixel-aligned property is set for it.

Note: The document level property and pixel-aligned status of each object are saved in the .ai file.

For more information on aligning symbols to pixel grid, see “[Aligning symbols to pixel grid](#)” on page 60.

Aligning existing objects to pixel grid

An object with the Align to Pixel Grid option selected, is nudged to align to pixel grid whenever it is modified. For example, if you move or transform a pixel-aligned object, the object is realigned to pixel grid according to its new coordinates.

To align an existing object to pixel grid, select the object and check the Align to Pixel Grid check box at the bottom on the Transform panel.

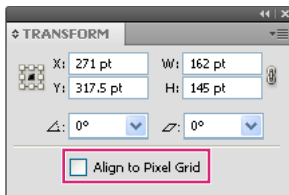

Align to Pixel Grid option in the Transform panel

When you select this option, the vertical and horizontal segments of the paths of the object are nudged. As a result, the appearance of such segments always shows crisp strokes, for all stroke widths and all locations. Objects with this option selected, always have stroke widths in full integer values.

Bringing non-aligned objects into documents with the Align New Objects to Pixel Grid option enabled, does not automatically pixel-align such objects. To make such objects pixel-aligned, select the object and then select the Align to Pixel Grid option from the Transform panel. You cannot pixel-align objects such as rasters, raster effects, and text objects because such objects do not have real paths.

Selecting objects not aligned to pixel grid

Click Select > Object > Not Aligned to Pixel Grid to select the objects.

Aligning symbols to pixel grid

To create a pixel-aligned symbol, select the Align to Pixel Grid option from the Symbol Options dialog box. Symbols aligned to pixel grid remain aligned to the pixel grid at all locations of the artboard, in their actual size.

Note: A scaled symbol may not produce crisp paths although it is pixel-aligned by property.

For more information on aligning to pixel grid, see “[Drawing pixel-aligned paths for web workflows](#)” on page 58.



If the Reset button in the Control panel is active, it implies that the symbol has been transformed and is not in its actual size.

Viewing the pixel grid

To view the pixel grid, zoom to 600% or higher in Pixel Preview mode.

To set the preferences for viewing pixel grid, click Preferences > Guides & Grid. Select the Show Pixel Grid (Above 600% Zoom) option if it is not already selected.

Saving selected slices

To save only selected slices from the artwork, click File > Save Selected Slices.

Anti-aliasing options

Text anti-aliasing

The Character panel in Illustrator provides the following text anti-aliasing options:

- None
- Sharp
- Crisp
- Strong

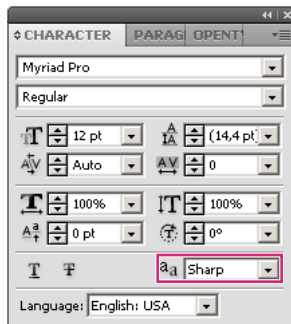

Text anti-aliasing options in the Character panel

You can set anti-aliasing options for each text frame. These text anti-aliasing attributes get saved as part of the document. These options are also supported for PDF, AIT, and EPS formats. Text anti-aliasing options can be exported to or imported from PSD.

While exporting to BMP, PNG, Targa, JPEG, or TIFF formats the following options are available in the anti-aliasing drop-down list: None, Art Optimized and Type Optimized.

- Art optimized option produces raster for each of these formats in the same way as in earlier versions. However, text anti-aliasing options are not honored while rasterizing the artwork in this case.
- Type optimized option honors the newly introduced anti-aliasing options for the text frames in the raster produced.

These options are also available in Save for Web dialog box.

Drawing with the Pencil tool

Draw with the Pencil tool

The Pencil tool works primarily the same way in Adobe Illustrator and InDesign. It lets you draw open and closed paths as if you were drawing with a pencil on paper. It is most useful for fast sketching or creating a hand-drawn look. Once you draw a path, you can immediately change it if needed.



Anchor points are set down as you draw with the Pencil tool; you do not determine where they are positioned. However, you can adjust them once the path is complete. The number of anchor points set down is determined by the length and complexity of the path and by tolerance settings in the Pencil Tool Preferences dialog box. These settings control how sensitive the Pencil tool is to the movement of your mouse or graphics-tablet stylus.

For a video on drawing with the Pencil tool in Illustrator, see www.adobe.com/go/vid0039.

More Help topics

[Pencil tool in Illustrator video](#)

Draw freeform paths with the Pencil tool

- 1 Select the Pencil tool .
- 2 Position the tool where you want the path to begin, and drag to draw a path. The Pencil tool  displays a small x to indicate drawing a freeform path.

As you drag, a dotted line follows the pointer. Anchor points appear at both ends of the path and at various points along it. The path takes on the current stroke and fill attributes, and remains selected by default.

Draw closed paths with the Pencil tool

- 1 Select the Pencil tool.
- 2 Position the tool where you want the path to begin, and start dragging to draw a path.
- 3 After you've begun dragging, hold down Alt (Windows) or Option (Mac OS). The Pencil tool displays a small circle (and, in InDesign, a solid eraser) to indicate that you're creating a closed path.
- 4 When the path is the size and shape you want, release the mouse button (but not the Alt or Option key). After the path closes, release the Alt or Option key.

You don't have to position the cursor over the starting point of the path in order to create a closed path; if you release the mouse button in some other location, the Pencil tool will close the shape by creating the shortest possible line back to the original point.

Edit paths with the Pencil tool

You can edit any path using the Pencil tool and add freeform lines and shapes to any shape.

Add to a path with the Pencil tool

- 1 Select an existing path.
- 2 Select the Pencil tool.
- 3 Position the pencil tip on an endpoint of the path.

You can tell you're close enough to the endpoint when the small x next to the pencil tip disappears.

- 4 Drag to continue the path.

Connect two paths with the Pencil tool

- 1 Select both paths (Shift-click or drag around the two with the Selection tool).
- 2 Select the Pencil tool.
- 3 Position the pointer where you want to begin from one path, and start dragging toward the other path.
- 4 After you begin dragging, hold down Ctrl (Windows) or Command (Mac OS). The Pencil tool displays a small merge symbol to indicate you're adding to the existing path.
- 5 Drag onto the endpoint of the other path, release the mouse button, and then release the Ctrl or Command key.

Note: For best results, drag from one path to the other as if you were simply continuing the paths in the direction they were created.

Reshape paths with the Pencil tool

- 1 Select the path you want to change.
- 2 Position the Pencil tool on or near the path to redraw.

You can tell you're close enough to the path when the small x disappears from the tool.

- 3 Drag the tool until the path is the desired shape.

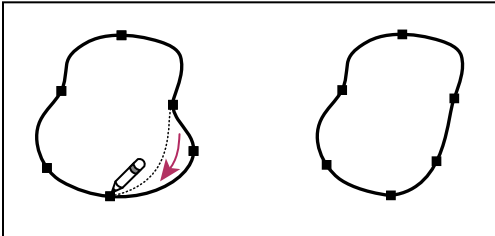

Using the Pencil tool to edit a closed shape

Note: Depending on where you begin to redraw the path and in which direction you drag, you may get unexpected results. For example, you may unintentionally change a closed path to an open path, change an open path to a closed path, or lose a portion of a shape.

Pencil tool options

Double-click the Pencil tool to set any of the following options:

Fidelity Controls how far you have to move your mouse or stylus before a new anchor point is added to the path. The higher the value, the smoother and less complex the path. The lower the value, the more the curves will match the pointer's movement, resulting in sharper angles. Fidelity can range from 0.5 to 20 pixels.

Smoothness Controls the amount of smoothing applied when you use the tool. Smoothness can range from 0% to 100%. The higher the value, the smoother the path. The lower the value, the more anchor points are created, and the more the line's irregularities are preserved.

Fill New Pencil Strokes (Illustrator only) Applies a fill to pencil strokes you draw after selecting this option, but not to existing pencil strokes. Remember to select a fill before you draw the pencil strokes.

Keep Selected Determines whether to keep the path selected after you draw it. This option is selected by default.

Edit Selected Paths Determines whether or not you can change or merge a selected path when you are within a certain distance of it (specified with the next option).

Within: _ pixels Determines how close your mouse or stylus must be to an existing path in order to edit the path with the Pencil tool. This option is only available when the Edit Selected Paths option is selected.

Drawing with the Pen tool

Draw straight line segments with the Pen tool

The simplest path you can draw with the Pen tool is a straight line, made by clicking the Pen tool to create two anchor points. By continuing to click, you create a path made of straight line segments connected by corner points.

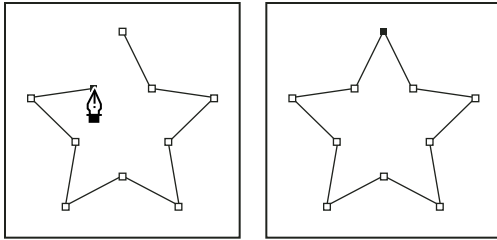

Clicking Pen tool creates straight segments.

- 1 Select the Pen tool.
- 2 Position the Pen tool where you want the straight segment to begin, and click to define the first anchor point (do not drag).

Note: The first segment you draw will not be visible until you click a second anchor point. (Select the Rubber Band option in Photoshop to preview path segments.) Also, if direction lines appear, you've accidentally dragged the Pen tool; choose Edit > Undo, and click again.

- 3 Click again where you want the segment to end (Shift-click to constrain the angle of the segment to a multiple of 45°).
- 4 Continue clicking to set anchor points for additional straight segments.

The last anchor point you add always appears as a solid square, indicating that it is selected. Previously defined anchor points become hollow, and deselected, as you add more anchor points.

- 5 Complete the path by doing one of the following:
 - To close the path, position the Pen tool over the first (hollow) anchor point. A small circle appears next to the Pen tool pointer  when it is positioned correctly. Click or drag to close the path.

Note: To close a path in InDesign, you can also select the object and choose Object > Paths > Close Path.

- To leave the path open, Ctrl-click (Windows) or Command-click (Mac OS) anywhere away from all objects.

To leave the path open, you can also select a different tool, or choose Select > Deselect in Illustrator or Edit > Deselect All in InDesign. In InDesign or Illustrator, you can also simply press Enter or Return to leave the path open.

Draw curves with the Pen tool

You create a curve by adding an anchor point where a curve changes direction, and dragging the direction lines that shape the curve. The length and slope of the direction lines determine the shape of the curve.

Curves are easier to edit and your system can display and print them faster if you draw them using as few anchor points as possible. Using too many points can also introduce unwanted bumps in a curve. Instead, draw widely spaced anchor points, and practice shaping curves by adjusting the length and angles of the direction lines.

- 1 Select the Pen tool.
- 2 Position the Pen tool where you want the curve to begin, and hold down the mouse button.

The first anchor point appears, and the Pen tool pointer changes to an arrowhead. (In Photoshop, the pointer changes only after you've started dragging.)

- 3 Drag to set the slope of the curve segment you're creating, and then release the mouse button.

In general, extend the direction line about one third of the distance to the next anchor point you plan to draw. (You can adjust one or both sides of the direction line later.)

Hold down the Shift key to constrain the tool to multiples of 45°.

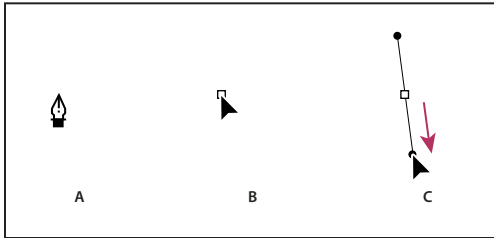

Drawing the first point in a curve

A. Positioning Pen tool B. Starting to drag (mouse button pressed) C. Dragging to extend direction lines

4 Position the Pen tool where you want the curve segment to end, and do one of the following:

- To create a C-shaped curve, drag in a direction opposite to the previous direction line. Then release the mouse button.

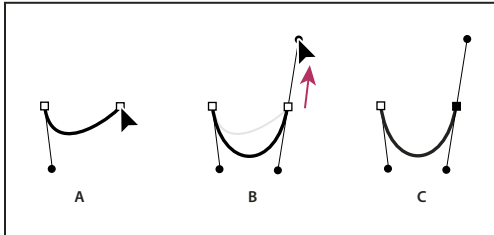

Drawing the second point in a curve

A. Starting to drag second smooth point B. Dragging away from previous direction line, creating a C curve C. Result after releasing mouse button

- To create an S-shaped curve, drag in the same direction as the previous direction line. Then release the mouse button.

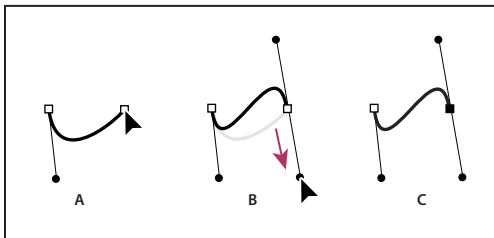

Drawing an S curve

A. Starting to drag new smooth point B. Dragging in same direction as previous direction line, creating an S curve C. Result after releasing mouse button

 (Photoshop only) To change the direction of the curve sharply, release the mouse button, and then Alt-drag (Windows) or Option-drag (Mac OS) the direction point in the direction of the curve. Release the Alt (Windows) or Option (Mac OS) key and the mouse button, reposition the pointer where you want the segment to end, and drag in the opposite direction to complete the curve segment.

5 Continue dragging the Pen tool from different locations to create a series of smooth curves. Note that you are placing anchor points at the beginning and end of each curve, not at the tip of the curve.

 Alt-drag (Windows) or Option-drag (Mac OS) direction lines to break out the direction lines of an anchor point.

Drawing

6 Complete the path by doing one of the following:

- To close the path, position the Pen tool over the first (hollow) anchor point. A small circle appears next to the Pen tool pointer  when it is positioned correctly. Click or drag to close the path.

Note: To close a path in InDesign, you can also select the object and choose Object > Paths > Close Path.

- To leave the path open, Ctrl-click (Windows) or Command-click (Mac OS) anywhere away from all objects.

To leave the path open, you can also select a different tool, or choose Select > Deselect in Illustrator or Edit > Deselect All in InDesign.

For a video on using the Pen tool in Illustrator, see www.adobe.com/go/vid0037.

More Help topics

[Pen tool in Illustrator video](#)

Reposition anchor points as you draw

- ❖ After you click to create an anchor point, keep the mouse button pressed down, hold down the spacebar, and drag to reposition the anchor point.

Finish drawing a path

- ❖ Complete a path in one of the following ways:

- To close a path, position the Pen tool over the first (hollow) anchor point. A small circle appears next to the Pen tool pointer  when it is positioned correctly. Click or drag to close the path.

Note: To close a path in InDesign, you can also select the object and choose Object > Paths > Close Path.

- To leave a path open, Ctrl-click (Windows) or Command-click (Mac OS) anywhere away from all objects.

To leave the path open, you can also select a different tool, or choose Select > Deselect in Illustrator or Edit > Deselect All in InDesign. In InDesign, you can also simply press Enter or Return to leave the path open.

Draw straight lines followed by curves

- 1 Using the Pen tool, click corner points in two locations to create a straight segment.
- 2 Position the Pen tool over the selected endpoint. In Illustrator and InDesign, a convert-point icon appears next to the Pen tool when it is positioned correctly (In Photoshop, a small diagonal line, or slash, appears next to the Pen tool). To set the slope of the curved segment you'll create next, click the anchor point, and drag the direction line that appears.

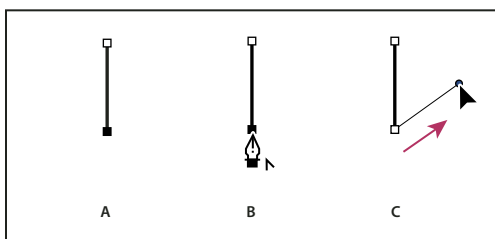

Drawing a straight segment followed by a curved segment (part 1)

A. Straight segment completed **B.** Positioning Pen tool over endpoint (the Convert Point icon appears only in Illustrator and InDesign)
C. Dragging direction point

Drawing

- 3 Position the pen where you want the next anchor point; then click (and drag, if desired) the new anchor point to complete the curve.

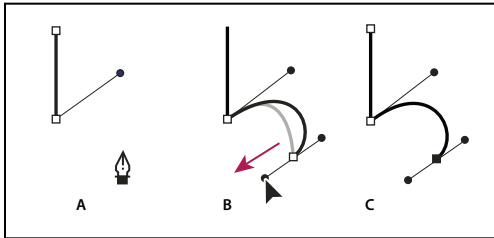

Drawing a straight segment followed by a curved segment (part 2)
 A. Positioning Pen tool B. Dragging direction line C. New curve segment completed

Draw curves followed by straight lines

- 1 Using the Pen tool, drag to create the first smooth point of the curved segment, and release the mouse button.
- 2 Reposition the Pen tool where you want the curved segment to end, drag to complete the curve, and release the mouse button.

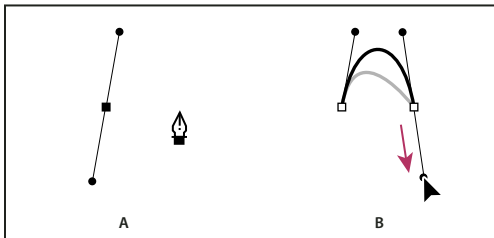

Drawing a curved segment followed by a straight segment (part 1)
 A. First smooth point of curved segment completed and Pen tool positioned over endpoint B. Dragging to complete the curve

- 3 Position the Pen tool over the selected endpoint. A convert-point icon appears next to the Pen tool when it is positioned correctly. Click the anchor point to convert the smooth point to a corner point.
- 4 Reposition the Pen tool where you want the straight segment to end, and click to complete the straight segment.

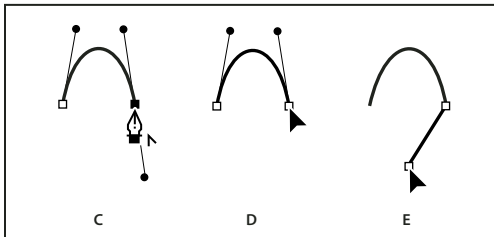

Drawing a curved segment followed by a straight segment (part 2)
 C. Positioning Pen tool over existing endpoint D. Clicking endpoint E. Clicking next corner point

Draw two curved segments connected by a corner

- 1 Using the Pen tool, drag to create the first smooth point of a curved segment.
- 2 Reposition the Pen tool and drag to create a curve with a second smooth point; then press and hold Alt (Windows) or Option (Mac OS) and drag the direction line toward its opposing end to set the slope of the next curve. Release the key and the mouse button.

This process converts the smooth point to a corner point by splitting the direction lines.

Drawing

- 3 Reposition the Pen tool where you want the second curved segment to end, and drag a new smooth point to complete the second curved segment.

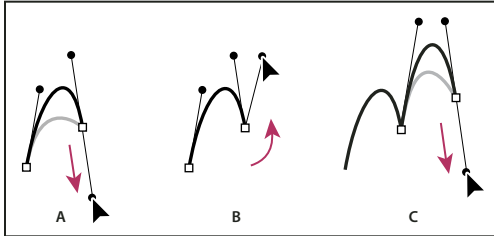

Drawing two curves

A. Dragging a new smooth point B. Pressing Alt/Option to split direction lines while dragging, and swinging direction line up C. Result after repositioning and dragging a third time

Editing paths

Select paths, segments, and anchor points



Before you can reshape or edit a path, you need to select the path's anchor points, segments, or a combination of both.

Select anchor points

- If you can see the points, you can click them with the Direct Selection tool  to select them. Shift-click to select multiple points.
- Select the Direct Selection tool and drag a boundary around the anchor points. Shift-drag around additional anchor points to select them.
- Make sure the path that contains the anchor points is not selected. Move the Direct Selection tool over the anchor point until the pointer displays a hollow square, and then click the anchor point. Shift-click additional anchor points to select them.
- (Illustrator only) Select the Lasso tool, and drag around the anchor points. Shift-drag around additional anchor points to select them.

Select path segments

Do any of the following:

- Select the Direct Selection tool , and click within 2 pixels of the segment, or drag a marquee over part of the segment. Shift-click or Shift-drag around additional path segments to select them.
- (Illustrator only) Select the Lasso tool , and drag around part of the path segment. Shift-drag around additional path segments to select them.

Select all anchor points and segments in a path

- 1 Select the Direct Selection tool  or, in Illustrator, the Lasso tool.
- 2 Drag around the entire path.

If the path is filled, you can also click inside the path with the Direct Selection tool to select all anchor points.

Copy a path

- ❖ Select a path or segment with the Selection tool or Direct Selection tool and do one of the following:
 - Use the standard menu functions to copy and paste paths within or between applications.
 - Press and hold Alt (Windows) or Option (Mac OS) and drag the path to the desired position, and then release the mouse button and Alt/Option key.

Adjust path segments

Editing path segments works similarly in Adobe applications. You can edit a path segment at any time, but editing existing segments is slightly different from drawing them. Keep the following tips in mind when editing segments:

- If an anchor point connects two segments, moving that anchor point always changes both segments.
- When drawing with the Pen tool, press Ctrl (Windows) or Command (Mac OS) to temporarily activate the last used selection tool (Illustrator) or the Direct Selection tool (InDesign and Photoshop) so that you can adjust segments you've already drawn.
- When you initially draw a smooth point with the Pen tool, dragging the direction point changes the length of the direction line on both sides of the point. However, when you edit an existing smooth point with the Direct Selection tool, you change the length of the direction line only on the side you're dragging.

More Help topics

[“Select paths, segments, and anchor points”](#) on page 68

[“Reshaping tool gallery”](#) on page 21

Move straight segments

- 1 With the Direct Selection tool , select the segment you want to adjust.
- 2 Drag the segment to its new position.

Adjust the length or angle of straight segments

- 1 With the Direct Selection tool , select an anchor point on the segment you want to adjust.
- 2 Drag the anchor point to the desired position. Shift-drag to constrain the adjustment to multiples of 45°.

 *In Illustrator or InDesign, if you're simply trying to make a rectangle wider or narrower, it's easier to select it with the Selection tool and resize it using one of the handles on the sides of its bounding box.*

Adjust the position or shape of curved segments

- 1 With the Direct Selection tool, select a curved segment, or an anchor point on either end of the curved segment. Direction lines appear, if any are present. (Some curved segments use just one direction line.)
- 2 Do any of the following:
 - To adjust the position of the segment, drag the segment. Shift-drag to constrain the adjustment to multiples of 45°.

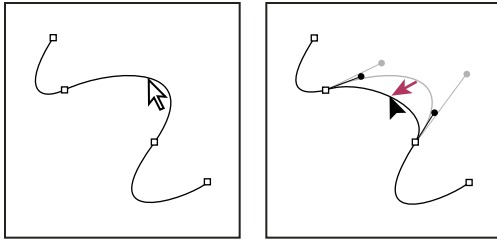

Click to select the curve segment. Then drag to adjust.

- To adjust the shape of the segment on either side of a selected anchor point, drag the anchor point or the direction point. Shift-drag to constrain movement to multiples of 45°.

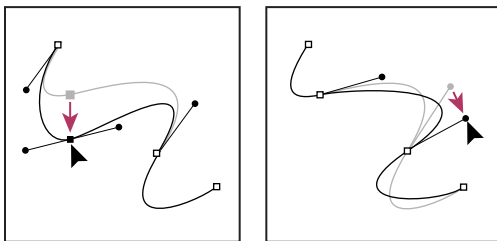

Drag the anchor point, or drag the direction point.

Note: You can also apply a transformation, such as scaling or rotating, to a segment or anchor point.

Delete a segment

- 1 Select the Direct Selection tool , and select the segment you want to delete.
- 2 Press Backspace (Windows) or Delete (Mac OS) to delete the selected segment. Pressing Backspace or Delete again erases the rest of the path.

Extend an open path

- 1 Using the Pen tool, position the pointer over the endpoint of the open path you want to extend. The pointer changes when it's precisely positioned over the endpoint.
- 2 Click the endpoint.
- 3 Do one of the following:
 - To create a corner point, position the Pen tool where you want to end the new segment, and click. If you are extending a path that ends at a smooth point, the new segment will be curved by the existing direction line.

Note: In Illustrator, if you extend a path that ends in a smooth point, the new segment will be straight.

- To create a smooth point, position the Pen tool where you want to end the new curved segment, and drag.

Connect two open paths

- 1 Using the Pen tool, position the pointer over the endpoint of the open path that you want to connect to another path. The pointer changes when it's precisely positioned over the endpoint.
- 2 Click the endpoint.
- 3 Do one of the following:
 - To connect the path to another open path, click an endpoint on the other path. When you precisely position the Pen tool over the other path's endpoint, a small merge symbol  appears next to the pointer.

- To connect a new path to an existing path, draw the new path near the existing path, and then move the Pen tool to the existing path's (unselected) endpoint. Click that endpoint when you see the small merge symbol that appears next to the pointer.

 *In InDesign, you can also use the Pathfinder panel to join paths. To close the path of an open path, use the Selection tool to select the path and click Close Path in the Pathfinder panel. To close the end points between two paths, select the paths and click Join Path. You may want to click Join Path a second time to join the second endpoint.*

Join two endpoints

- 1 Select the endpoints.

If the endpoints are coincident (on top of each other), drag a marquee through or around both endpoints to select them.

- 2 Click the Connect Selected End Points button  in the Control panel.

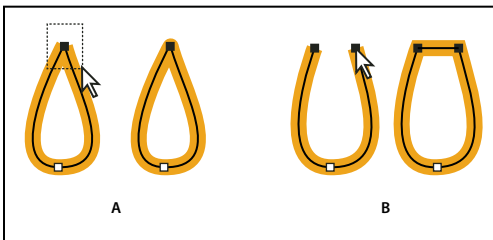

Joining endpoints

A. Selecting and joining coincident endpoints B. Selecting and joining noncoincident endpoints

Note: *In Illustrator CS5, only corner joins are used to join open paths.*

Join two or more paths

Illustrator CS5 provides the option to join two or more open paths. To join one or more open paths, use the Selection tool to select the open paths and click Object > Path > Join. You can also use the keyboard shortcut Ctrl+J (Windows) or Cmd+J (Mac).

When anchor points are not overlapping, Illustrator adds a line segment to bridge the paths to join. While joining more than two paths, Illustrator first looks for and joins the paths that have end points stationed closest to each other. This process is repeated until all paths are joined. If you select only one path to join, it is converted into a closed path.

Note: *In this process, you may lose complex aspects of your art styles.*

The output path has the appearance of the topmost path in the selection.

The join option only results in a corner join regardless of whether you select anchor points to join or the entire path. However, for overlapping anchor points, if you want the option to select a smooth or corner join, then use Ctrl+Shift+Alt+J (Windows) or Cmd+Shift+Option+J (Mac OS).

Move or nudge anchor points or segments using the keyboard

- 1 Select the anchor point or path segment.



Note: *In Photoshop, you can move only anchor points in this manner.*

- 2 Click or hold down any of the arrow keys on the keyboard to move 1 pixel at a time in the direction of the arrow.

Hold down the Shift key in addition to the arrow key to move 10 pixels at a time.

Note: In Illustrator and InDesign, you can change the distance of a nudge by changing the Keyboard Increment preference. When you change the default increment, holding down Shift nudges 10 times the specified distance.

Stretch parts of a path without distorting its overall shape





- 1 Select the entire path.
- 2 Select the Reshape tool  (located under the Scale tool ).
- 3 Position the cursor over the anchor point or path segment that you want to act as a focal point (that is, a point that pulls selected path segments), and click.

If you click a path segment, a highlighted anchor point with a square around it is added to the path.

- 4 Shift-click more anchor points or path segments to act as focal points. You can highlight an unlimited number of anchor points or path segments.
- 5 Drag the highlighted anchor points to adjust the path.

Adding and deleting anchor points

Adding anchor points can give you more control over a path, or it can extend an open path. However, it's a good idea not to add more points than necessary. A path with fewer points is easier to edit, display, and print. You can reduce the complexity of a path by deleting unnecessary points. Adding and deleting anchor points works similarly in Adobe applications.

The Tools panel contains three tools for adding or deleting points: the Pen tool , the Add Anchor Point tool , and the Delete Anchor Point tool . In addition, the Control panel has a Remove Selected Anchor Points button .

By default, the Pen tool changes to the Add Anchor Point tool as you position it over a selected path, or to the Delete Anchor Point tool as you position it over an anchor point.

Note: Don't use the Delete and Backspace keys or the Edit > Cut and Edit > Clear commands to delete anchor points: these keys and commands delete the point and the line segments that connect to that point.

More Help topics

["Drawing tool gallery"](#) on page 18

["Select paths, segments, and anchor points"](#) on page 68

Add or delete anchor points

- 1 Select the path you want to modify.
- 2 To add an anchor point, select the Pen tool or the Add Anchor Point tool, position the pointer over the path segment, and click.
- 3 To delete an anchor point, do either of the following:
 - Select the point with the Direct Selection tool and click Remove Selected Anchor Points  in the Control panel.
 - Select the Pen tool or the Delete Anchor Point tool, position the pointer over the anchor point, and click.

Find and delete stray anchor points

Stray anchor points are individual points that are not connected to other anchor points. It is a good practice to find and delete stray anchor points.

- 1 Deselect all objects.

- 2 Choose Select > Object > Stray Points.
- 3 Choose Edit > Cut or Edit > Clear commands, or press Delete or Backspace on the keyboard.

Disable or temporarily override automatic Pen tool switching

You can temporarily override or disable automatic switching to the Add Anchor Point tool or Delete Anchor Point tool.

- To temporarily override switching, hold down Shift as you position the Pen tool over the selected path or an anchor point. This is useful when you want to start a new path on top of an existing path. To prevent Shift from constraining the Pen tool, release Shift before you release the mouse button.
- To disable switching, choose Edit > Preferences > General (Windows) or Illustrator > Preferences > General (Mac OS), and select Disable Auto Add/Delete.

Smooth and simplify paths

You can smooth the appearance of paths as well as simplify paths by removing excess anchor points.

More Help topics

[“Drawing tool gallery”](#) on page 18

[“Keys for editing shapes”](#) on page 479

[“Select paths, segments, and anchor points”](#) on page 68

Smooth paths

- 1 Select the object.
- 2 Select the Smooth tool .
- 3 Drag the tool along the length of the path segment you want to smooth out.
- 4 Continue smoothing until the stroke or path is the desired smoothness.

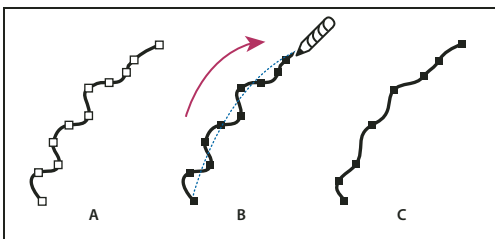

Using the Smooth tool

A. Original path B. Dragging across path with the Smooth tool C. Result

- 5 To change the amount of smoothing, double-click the Smooth tool and set the following options:
 - Fidelity** Controls how far you have to move your mouse or stylus before Illustrator adds a new anchor point to the path. For example, a Fidelity value of 2.5 means that tool movements of less than 2.5 pixels aren't registered. Fidelity can range from 0.5 to 20 pixels; the higher the value, the smoother and less complex the path.
 - Smoothness** Controls the amount of smoothing that Illustrator applies when you use the tool. Smoothness can range from 0% to 100%; the higher the value, the smoother the path.

Simplify paths

Simplifying a path removes extra anchor points without changing the shape of the path. Removing unnecessary anchor points simplifies your artwork, reducing the file size, and making it display and print faster.

- 1 Select the object.
- 2 Choose Object > Path > Simplify.
- 3 Set the Curve Precision to control how closely the simplified path follows the original path.

 *Select Preview to show a preview of the simplified path and list the number of points in the original and simplified paths.*

- 4 Select additional options, and click OK:

Curve Precision Enter a value between 0% and 100% to set how closely the simplified path should follow the original path. A higher percentage creates more points and a closer fit. Any existing anchor points are ignored except for endpoints of a curve and corner points (unless you enter a value for Angle Threshold).

Angle Threshold Enter a value between 0 and 180° to control the smoothness of corners. If the angle of a corner point is less than the angle threshold, the corner point is not changed. This option helps keep corners sharp, even if the value for Curve Precision is low.

Straight Lines Creates straight lines between the object's original anchor points. Corner points are removed if they have an angle greater than the value set in Angle Threshold.

Show Original Shows the original path behind the simplified path.

Average the position of anchor points

- 1 Select two or more anchor points (on the same path or on different paths).
- 2 Choose Object > Path > Average.
- 3 Choose to average along the horizontal (x) axis only, the vertical (y) axis only, or both axes, and click OK.

Convert between smooth points and corner points

You can convert the points on a path between corner to smooth points. Using options in the Control panel, you can quickly convert multiple anchor points. Using the Convert Anchor Point tool, you can choose to convert only one side of the point, and you can precisely alter the curve as you convert the point.

More Help topics

[“About paths”](#) on page 50

[“Drawing tool gallery”](#) on page 18

[“About direction lines and direction points”](#) on page 51

Convert one or more anchor points using the Control panel

To use the anchor point conversion options in the Control panel, only relevant anchor points, not the entire object, should be selected. If you select multiple objects, one of the objects must be only partially selected. When entire objects are selected, the Control panel options change to those that affect the entire object.

- 1 To convert one or more corner points to smooth points, select the points and then click the Convert Selected Anchor Points To Smooth  button in the Control panel.

- 2 To convert one or more smooth points to corner points, select the points and then click the Convert Selected Anchor Points To Corner  button in the Control panel.

Convert an anchor point precisely using the Convert Anchor Point tool

- 1 Select the entire path you want to modify so that you can see its anchor points.
- 2 Select the Convert Anchor Point tool .
- 3 Position the Convert Anchor Point tool over the anchor point you want to convert, and do one of the following:
 - To convert a corner point to a smooth point, drag a direction point out of the corner point.

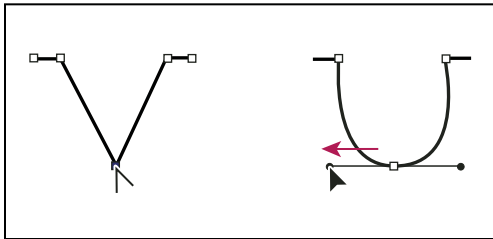

Dragging a direction point out of a corner point to create a smooth point

- To convert a smooth point to a corner point without direction lines, click the smooth point.

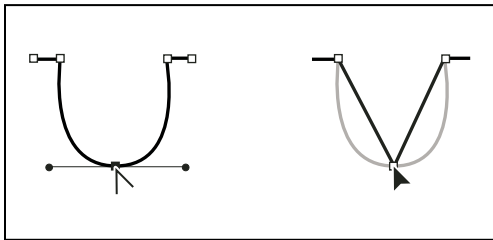

Clicking a smooth point to create a corner point

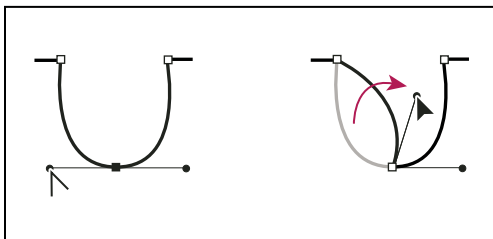

- To convert a smooth point to a corner point with independent direction lines, drag either direction point.



Converting a smooth point to a corner point

- To convert a corner point without direction lines to a corner point with independent direction lines, first drag a direction point out of a corner point (making it a smooth point with direction lines). Release the mouse button only (don't release any keys you may have pressed to activate the Convert Anchor Point tool), and then drag either direction point.

Erase artwork

You can erase portions of your artwork using the Path Eraser tool, the Eraser tool, or the eraser on a Wacom stylus pen. The Path Eraser tool  lets you erase parts of a path by drawing along the path. This tool is useful when you want to limit what you erase to a path segment, such as one edge of a triangle. The Eraser tool  and the eraser on a Wacom stylus pen let you erase any area of your artwork, regardless of structure. You can use the Eraser tool on paths, compound paths, paths inside Live Paint groups, and clipping paths.

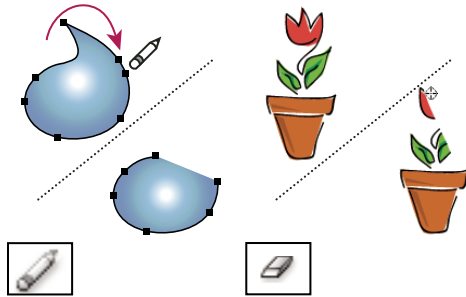

Using the Path Eraser tool to erase portions of a path (left), using the Eraser tool to erase part of a grouped object (right)

For a video on using the Eraser tool, see www.adobe.com/go/vid0036.

More Help topics

“Drawing tool gallery” on page 18

“Keys for editing shapes” on page 479

Erase part of a path using the Path Eraser tool

- 1 Select the object.
- 2 Select the Path Eraser tool .
- 3 Drag the tool along the length of the path segment you want to erase. For best results, use a single, smooth, dragging motion.

Erase objects using the Eraser tool

- 1 Do one the following:
 - To erase specific objects, select the objects or open the objects in isolation mode.
 - To erase any object on the artboard, leave all objects unselected.When you have nothing selected, the Eraser tool erases through and across all layers.
- 2 Select the Eraser tool .
- 3 (Optional) Double-click the Eraser tool and specify options.
- 4 Drag over the area you want to erase. You can control the tool by doing any of the following:
 - To constrain the Eraser tool to a vertical, horizontal, or diagonal line, Shift-drag.
 - To create a marquee around an area and erase everything inside the area, Alt-drag (Windows) or Option-drag (Mac OS). To constrain the marquee to a square, Alt-Shift-drag (Windows) or Option-Shift-drag (Mac OS).

Erase objects using a Wacom stylus pen eraser

When you flip a stylus pen, the Eraser Tool automatically becomes active. When you flip the stylus pen back over, the last active tool becomes active again.

- ❖ Turn over the stylus pen and drag across the area you want to erase.

Press harder to increase the width of the erased path. (You may need to select the Pressure option in the Eraser Tool Options dialog box first.)

Eraser tool options

You can change the Eraser tool options by double-clicking the tool in the Tools panel.

Note: You can change the diameter at any time by pressing **]** to enlarge or **[** to reduce.

Angle Determines the angle of rotation for the tool. Drag the arrowhead in the preview, or enter a value in the Angle text box.

Roundness Determines roundness of the tool. Drag a black dot in the preview away from or toward the center, or enter a value in the Roundness text box. The higher the value, the greater the roundness.

Diameter Determines the diameter of the tool. Use the Diameter slider, or enter a value in the Diameter text box.

The pop-up list to the right of each option lets you control variations in the shape of the tool. Select one of the following options:

Fixed Uses a fixed angle, roundness, or diameter.

Random Uses random variations in angle, roundness, or diameter. Enter a value in the Variation text box to specify the range within which the brush characteristic can vary. For example, when the Diameter value is 15 and the Variation value is 5, the diameter can be 10, or 20, or any value in between.

Pressure Varies in angle, roundness, or diameter based on the pressure of a drawing stylus. This option is most useful when used with Diameter. It is available only if you have a graphics tablet. Enter a value in the Variation text box to specify how much more or less the original value the brush characteristic will vary. For example, when the Roundness value is 75% and the Variation value is 25%, the lightest stroke is 50% and the heaviest stroke is 100%. The lighter the pressure, the more angular the brush stroke.

Stylus Wheel Varies in diameter based on manipulation of the stylus wheel.

Tilt Varies in angle, roundness, or diameter based on the tilt of a drawing stylus. This option is most useful when used with Roundness. It is available only if you have a graphics tablet that can detect the direction in which the pen is tilted.

Bearing Varies in angle, roundness, or diameter based on the pressure of a drawing stylus. This option is most useful when used to control the angle of calligraphic brushes, especially when you're using the brush like a paintbrush. It is available only if you have a graphics tablet that can detect how close to vertical the pen is.

Rotation Varies in angle, roundness, or diameter based on how the drawing stylus pen tip is rotated. This option is most useful when used to control the angle of calligraphic brushes, especially when you're using the brush like a flat pen. It is available only if you have a graphics tablet that can detect this type of rotation.

Split a path

You can split a path at any anchor point or along any segment. When you split a path, keep the following in mind:

- If you want to split a closed path into two open paths, you must slice in two places along the path. If you slice a closed path only once, you get a single path with a gap in it.

- Any paths resulting from a split inherit the path settings of the original path, such as stroke weight and fill color. Stroke alignment is automatically reset to center.
- 1 (Optional) Select the path to see its current anchor points.
 - 2 Do one of the following:
 - Select the Scissors tool and click the path where you want to split it. When you split the path in the middle of a segment, the two new endpoints appear on top of the other, and one endpoint is selected.
 - Select the anchor point where you want to split the path, and then click the Cut Path At Selected Anchor Points button  in the Control panel. When you split the path at an anchor point, a new anchor point appears on top of the original anchor point, and one anchor point is selected.
 - 3 Use the Direct Selection tool to adjust the new anchor point or path segment.

Note: You can divide an object into separate component faces by using the Knife tool (a face is an area undivided by a line segment).

More Help topics

“Cut objects with the Knife tool” on page 246

Perspective drawing

Introducing perspective drawing

In Illustrator CS5, you can easily draw or render artwork in perspective using a feature set that works on established laws of perspective drawing.

Perspective grid allows you to approximately represent a scene on a flat surface, as it is naturally perceived (by the human eye). For example, a road or a pair of railway tracks, which seem to meet or vanish in the line of vision.

The following features in Illustrator facilitate drawing in perspective:

- Utilities to define or edit one, two, and three vanishing point perspectives in a document.
- Control different perspective-defining parameters interactively.
- Create objects directly in perspective.
- Bring existing objects in perspective.
- Transform objects in perspective (move and scale objects).
- Move or duplicate objects toward a perpendicular plane (perpendicular movement).
- Define real world objects and draw objects with the specified real world measurements in perspective.

For a video on perspective drawing, see www.adobe.com/go/Irvid5205_ai_en.

About Perspective Grid

To view the default two-point perspective grid in a document, you can do any of the following:

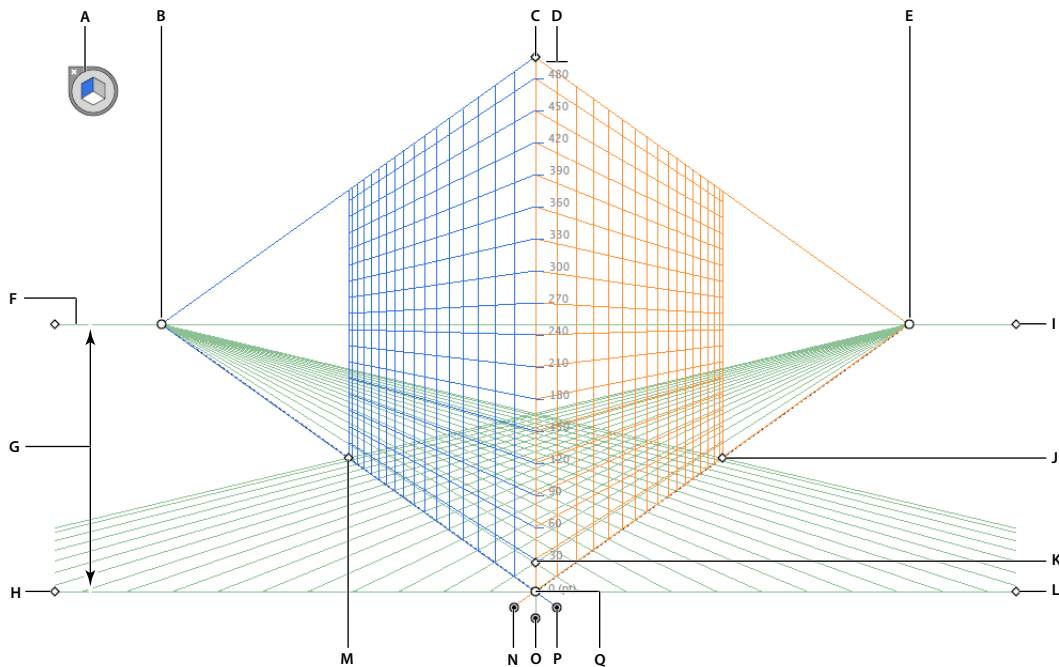

- Click View > Perspective Grid > Show Grid.
- Press Ctrl+Shift+I (on Windows) or Cmd+Shift+I (on Mac) to show the Perspective Grid. The same keyboard shortcut can be used to hide the visible grid.

- Click the Perspective Grid tool from the Tools panel.



Perspective Grid

A. Plane switching widget B. Left Vanishing Point C. Vertical Grid Extent D. Perspective Grid Ruler E. Right Vanishing Point F. Horizon Line G. Horizon Height H. Ground Level I. Horizon Level J. Extent of Grid K. Grid Cell Size L. Ground Level M. Extent of Grid N. Right Grid Plane Control O. Horizontal Grid Plane Control P. Left Grid Plane Control Q. Origin

The Perspective Grid tool group consists of the Perspective Grid tool  and the Perspective Selection tool .

You can select the Perspective Grid tool from the Tools panel or press Shift+P. When the Perspective Grid tool is selected, it shows:

- Left and right grid controls to adjust planes (see “[Adjust vanishing points, grid planes, horizon height, grid cell size, and grid extent](#)” on page 83)
- Horizon height (see “[Precise perpendicular movement](#)” on page 89)
- Left and right vertical plane position
- Visibility and extent of a grid cell
- Grid cell size
- Origin
- Left and right ground level widgets used for grid movement (see “[Move the perspective grid](#)” on page 83)

In addition, when you select the Perspective Grid, a Plane Switching Widget also appears. You can use this widget to select the active grid plane. In Perspective Grid, an active plane is the plane on which you draw an object to project the observer’s view of that portion of the scene.

Drawing

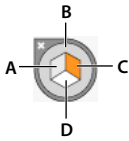

A. Left Grid Plane B. No Active Grid Plane C. Right Grid Plane D. Horizontal Grid Plane

Plane Switching Widget

For a video on defining the perspective grid, see www.adobe.com/go/lrvid5205_ai_en.

You can set options to position the widget on any of the four screen corners and choose to display it when the Perspective Grid is visible. To set these options, double-click the Perspective Grid icon in the Tools panel. In the Perspective Grid Options dialog box, you can select the following:

Show Active Plane Widget This option is selected by default. If you deselect this check box, then the widget is not displayed with the Perspective Grid.

Widget Position You can choose to display the widget on the upper left, upper-right, lower-left, or lower-right corner of the document window.

When you select the Perspective Selection tool, the left, right, and horizontal grid controls are displayed. You can switch to the Perspective Selection tool by pressing Shift+V or selecting it from the Tools panel. The Perspective Selection tool enables you to:

- Bring objects, texts, and symbols in perspective
- Switch active planes using keyboard shortcuts
- Move, scale, and duplicate objects in perspective space
- Move and duplicate objects perpendicular to its current position in the perspective plane. (see “[Precise perpendicular movement](#)” on page 89)

With the Perspective Selection tool, the active planes in the perspective grid are indicated by the following pointers.

Active Plane	Pointers
Left Grid Plane	
Right Grid Plane	
Horizontal Grid Plane	

The Perspective Selection tool snaps the objects to the grid of the active plane while moving, scaling, duplicating, and bringing objects into perspective. Objects snap to the grid lines within 1/4th distance of the cell size.

You can enable or disable snapping from View > Perspective Grid > Snap to Grid.

This option is enabled by default.

Perspective grid presets

Illustrator provides presets for one-point, two-point, and three-point perspectives.

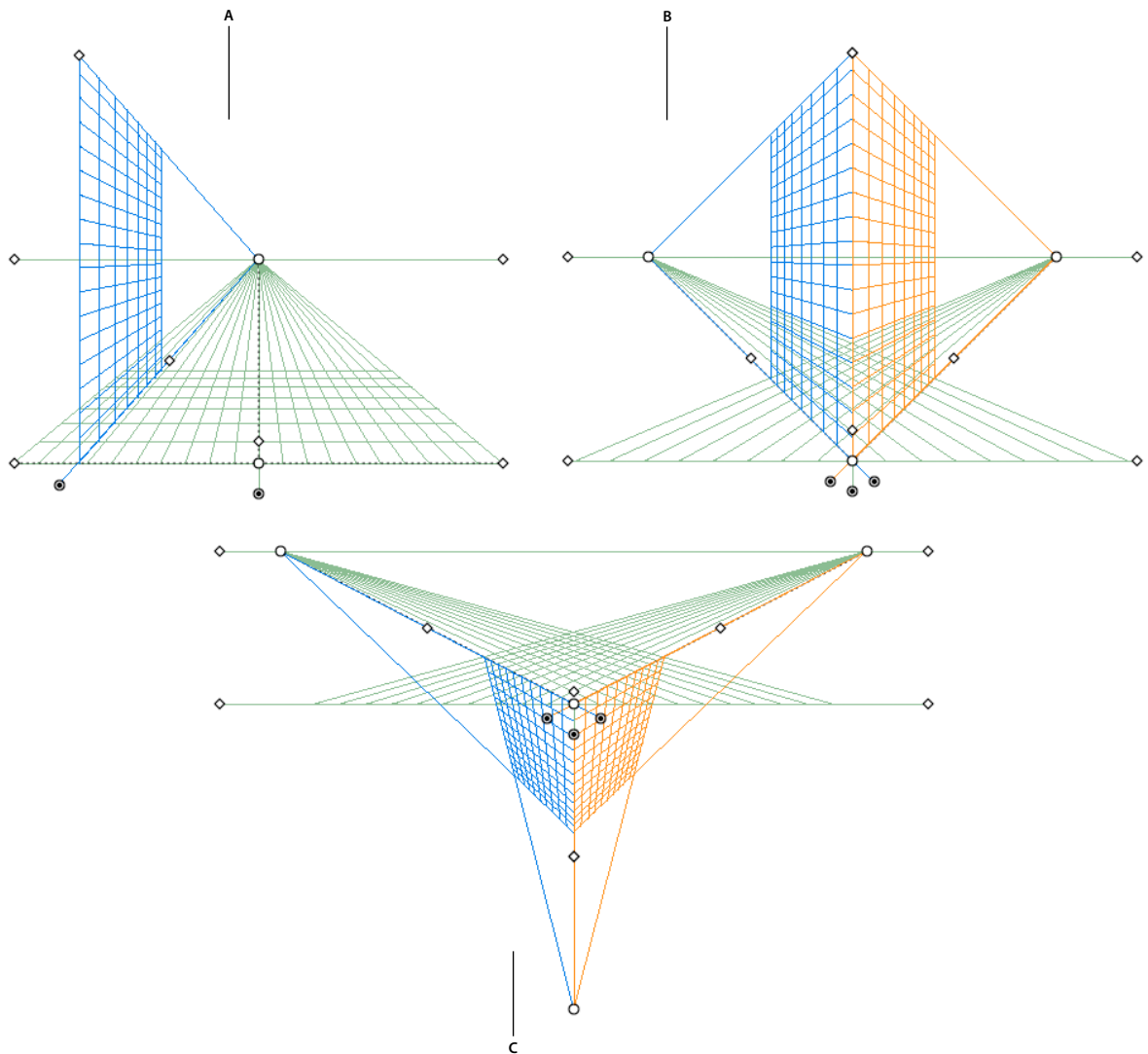

Perspective Grid Presets
A. 1-point perspective B. 2-point perspective (default) C. 3-point perspective

To select one of the default perspective grid preset, click View > Perspective Grid and then select from the required preset.

Define grid presets

To define grid settings, click View > Perspective Grid > Define Grid. In the Define Perspective Grid dialog box, you can configure the following attributes for a preset:

Name To save a new preset, select the Custom option from the Name drop-down list.

Type Select the type of preset: One Point Perspective, Two Point Perspective, or Three Point Perspective.

Units Select the units to measure the grid size. The options are centimeters, inches, pixels, and points.

Scale Select the grid scale to view or set the artboard and real-world measurements. To customize the scale, select the Custom option. In the Custom Scale dialog box, specify the Artboard and Real World proportions.

Gridline every This attribute determines the grid cell size.

Viewing Angle Imagine a cube in such an orientation that no face is parallel to the picture plane (in this case the computer screen). Viewing Angle is the angle which the right face of this imaginary cube makes with the picture plane. Therefore, the viewing angle determines the positions of the left and right vanishing points from the observer. A viewing angle of 45° implies that the two vanishing points are equidistant from the line of vision of the observer. If the viewing angle is greater than 45°, then the right vanishing point is closer to and the left vanishing point is farther away from the line of vision and vice versa.

Viewing Distance Distance between the observer and the scene.

Horizon Height Specify the horizon height (observer's eye level) for the preset. The height of the horizon line from the ground level is displayed in the smart guide readout.

Third Vanishing Point This option is enabled when you select the three-point perspective. You can specify the x and y coordinates for the preset in the X and Y boxes.

To change the colors for the left, right, and horizontal grids, select the color from the Left Grid, Right Grid, and Horizontal Grid drop-down lists. You can also select a custom color from using the Color Selector as well.

Use the Opacity slider, to change the opacity of the grid.

To save the grid as a preset, click the Save Preset button.

Edit, delete, import, and export grid presets

To edit grid presets, click Edit > Perspective Grid Presets. In the Perspective Grid Presets dialog box, select the preset to edit and click Edit.

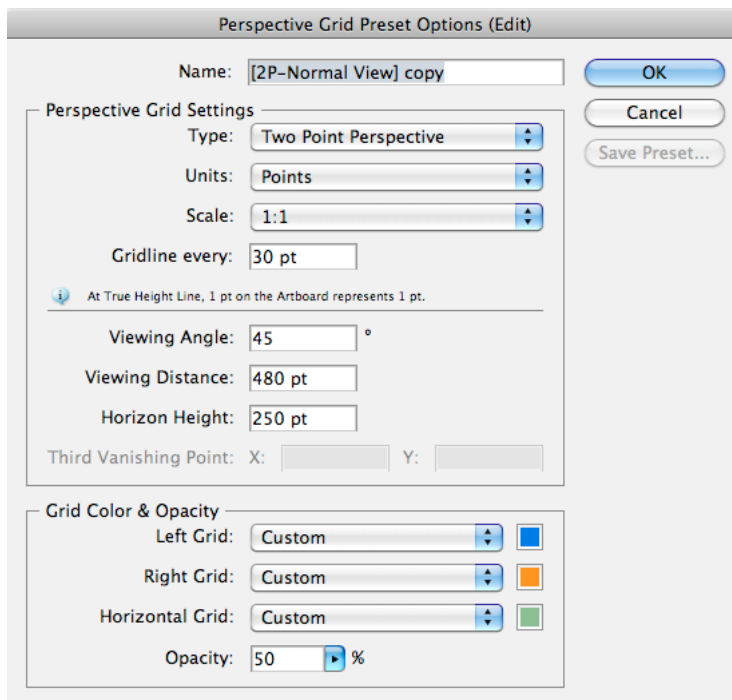

Perspective Grid Presets dialog box

The Perspective Grid Preset Options dialog box opens in edit mode. Enter the new grid setting and click OK to save the new grid settings.

Drawing

You cannot delete the default presets. To delete a user-defined preset, click Delete in the Perspective Grid Presets dialog box.

Illustrator also allows you to import and export user-defined presets. To export a particular preset, click Export in the Perspective Grid Presets dialog box. To import a preset, click Import.

Move the perspective grid

Illustrator can create only one grid in an Illustrator document. You can move the grid across artboards using the Ground level widget while the Perspective Grid tool is selected, to place it at the required position.

Note: You must select the Perspective Grid tool to perform this task because the ground level widget is not displayed if this tool is not selected.

To move the perspective grid do the following:

- 1 Select the Perspective Grid tool from the Tools panel or press Shift+P.
- 2 Drag-and-drop the left or right ground level widget on the grid. When you move the pointer over the ground level point, the pointer changes to .

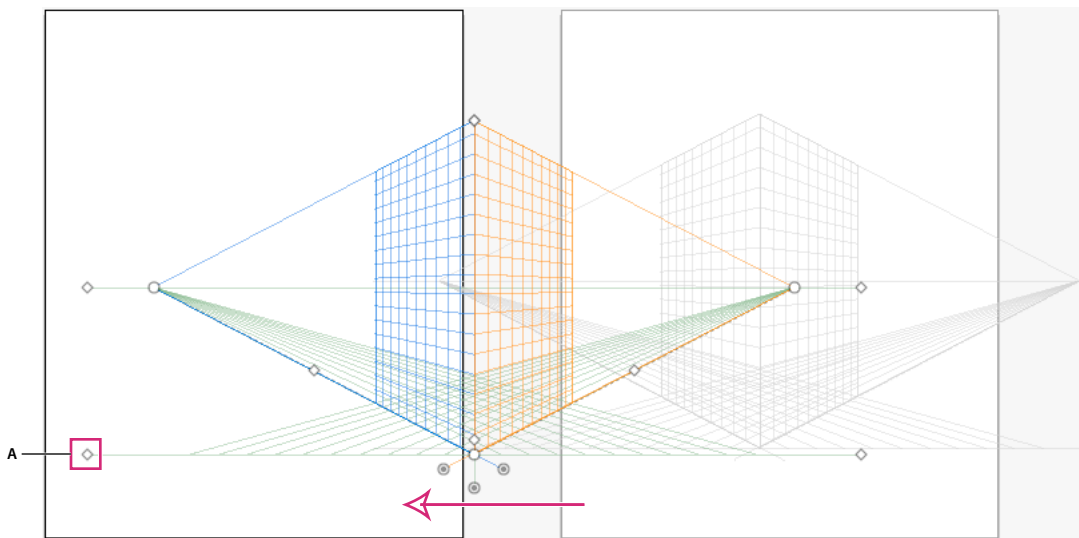

Moving the perspective grid across artboards using the left ground level widget (shown as A)

Adjust vanishing points, grid planes, horizon height, grid cell size, and grid extent

You can manually adjust vanishing points, grid plane controls, horizon height, and cell size using the respective widgets. However, these widgets are only visible with the Perspective Grid tool selected.

To adjust the left and right vanishing points use the left and right vanishing point widgets. Notice that the pointer changes to a two-way arrow pointer () when you move the pointer over the vanishing points.

Note: While adjusting the third vanishing point in 3-point perspective, holding down the Shift key constrains the movement to vertical axis.

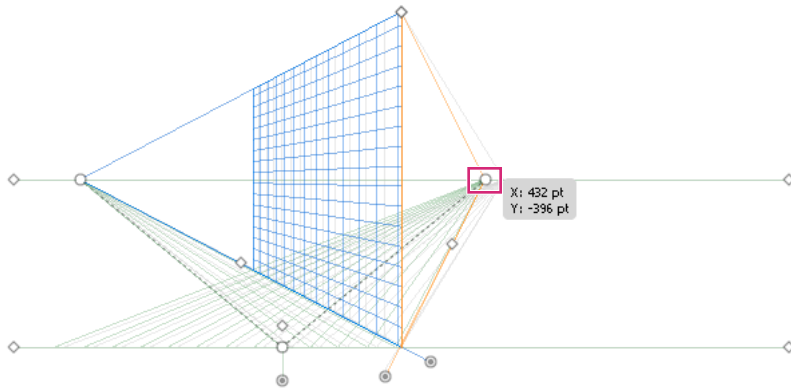

Moving the right vanishing point in a two-point perspective grid

Note: If you lock the station point using the View > Perspective Grid > Lock Station Point option, then both the vanishing points move together.

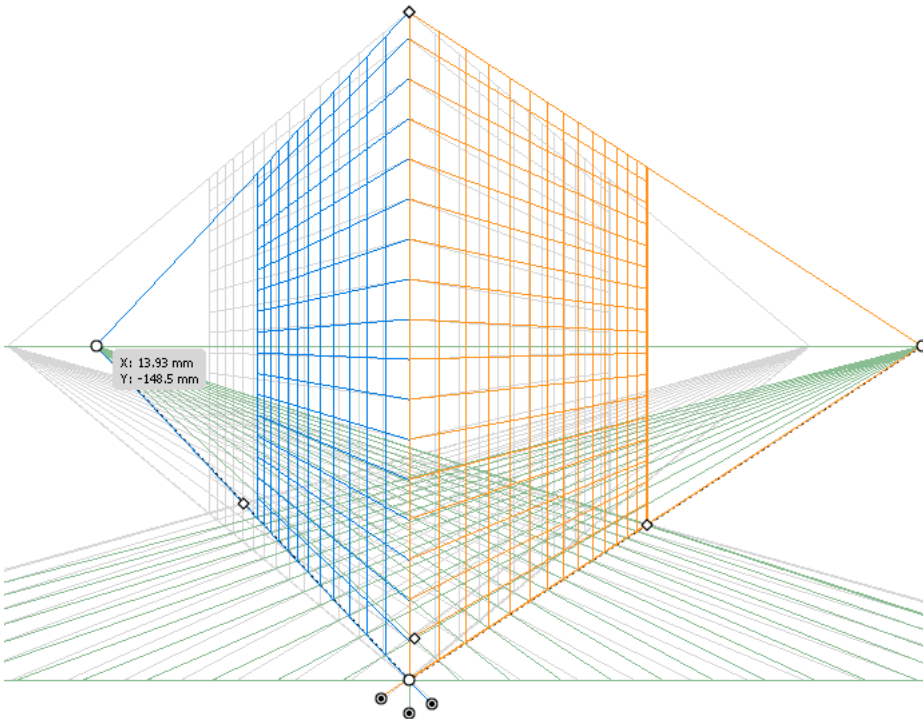

Both vanishing points move when station point is locked.

You can also adjust the left, right, and horizontal grid planes using the respective grid plane control widgets. The pointer changes to a two-way arrow (↔, ⇕) when you move the pointer over the grid plane controls.

Holding the Shift key while moving the grid planes, constrains the movement to the extent of cell size.

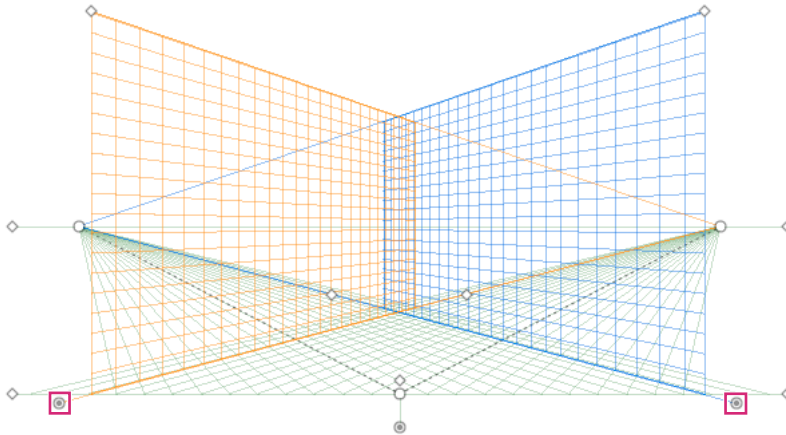

Adjusting the left and right grid planes in a two-point perspective

If you shift the origin, the x and y coordinates of the horizontal plane and the x coordinate of vertical planes are affected. When you select an object in perspective while the grid is visible, the x and y coordinates displayed in the Transform and Info panels change with shift in origin. You can also see the change in coordinate measurements when you draw objects using the rectangle or line group tools and press Shift, while the relevant grid plane is active. If you move the mouse over the origin, the pointer changes to .

Note: If you move the ruler origin, you can see the station point.

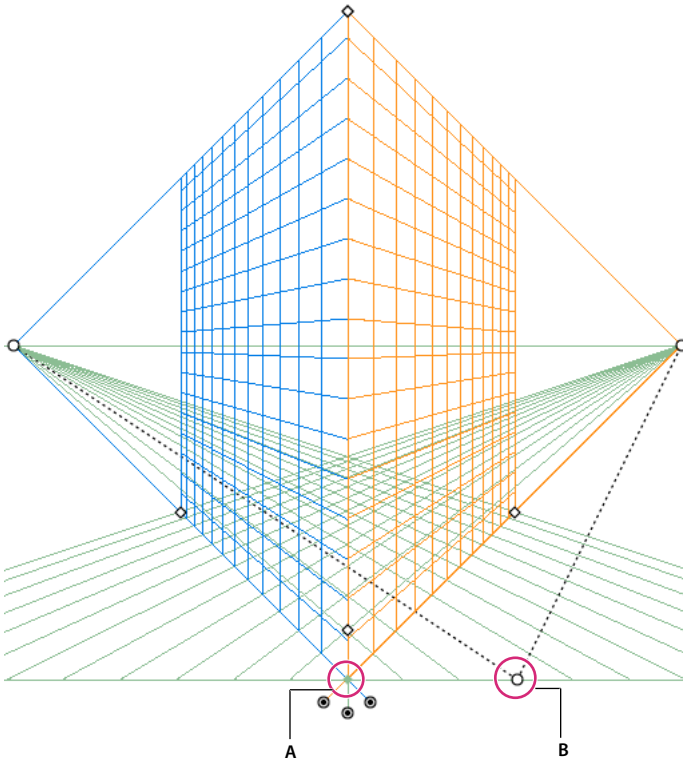

*Changing the ruler origin and viewing the station point
A. Station Point B. Changed Ruler Origin*

Adjust horizon height to fine-tune the observer's eye-level. When you move the pointer over the horizon line, the pointer changes to a vertical two-way arrow .

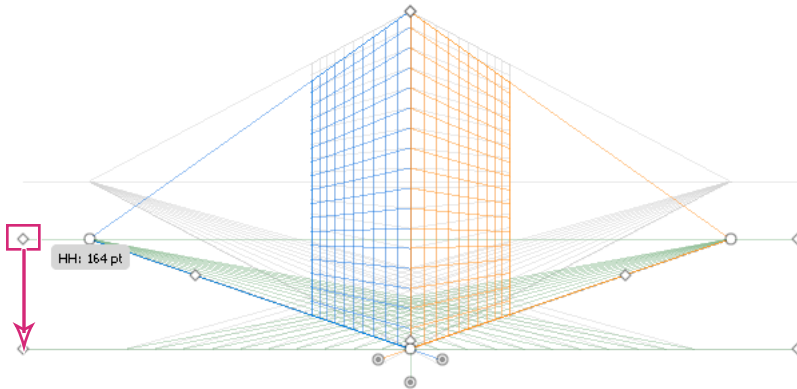

Adjusting the horizon height in a two-point perspective grid

You can change the grid extent to define the extent of the grid on the planes. When you move the pointer over the grid extent widgets, the pointer changes to .

Note: Gridlines are set to display onscreen when there is a 1-pixel gap in them. Progressive zooming in brings in view more gridlines that are closer toward Vanishing Point.

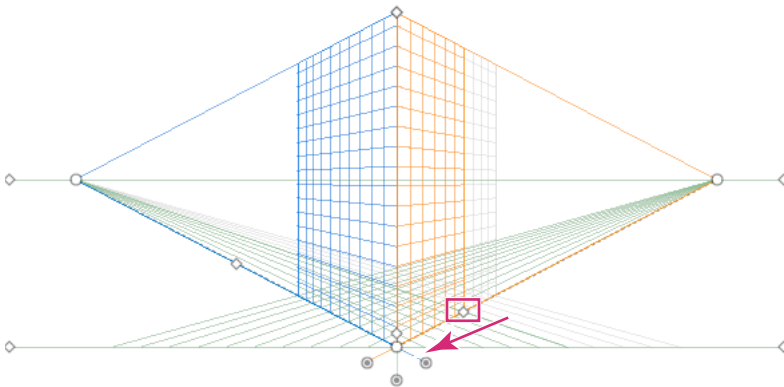

Moving the right grid extent away from the right vanishing point in a two-point perspective grid

You can also adjust the grid extent to increase or decrease the vertical grid extent.

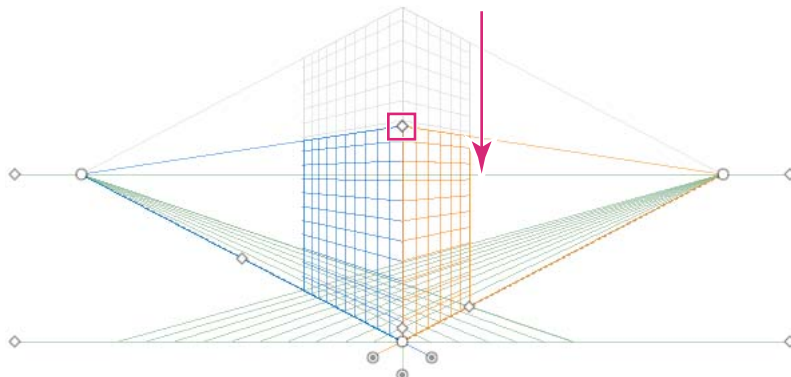

Adjusting the grid extent to decrease the vertical grid extent

To increase or decrease the grid cell size, use the grid cell size widget. When you mouse over the grid cell size widget, the pointer changes to .

Note: When you increase the grid cell size, the number of grid cells reduce.

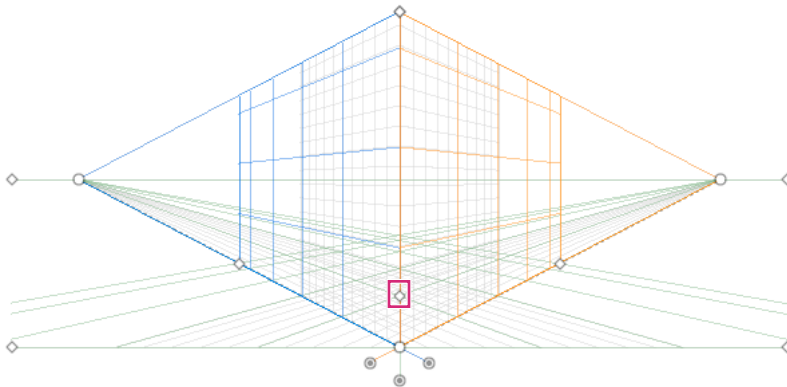

Increasing the grid cell size by dragging the grid cell size widget.

Drawing new objects in perspective

To draw objects in perspective, use the line group tools or rectangle group tools while the grid is visible. While using the rectangle or line group tools, you can switch to the Perspective Selection tool by pressing Cmd (Mac OS) or Ctrl (Windows).

You can also switch the active plane using the keyboard shortcut 1 (left plane), 2 (horizontal plane), and 3 (right plane) with these tools selected.

Note: The Flare tool is not supported with Perspective Grid.

When you draw an object in perspective, use Smart Guides to align the object to other objects. The alignment is based on the perspective geometry of objects. Guides appear as the object approaches the edge or anchor point of other objects.

You can use numerical values for any of the rectangle or line group tools (other than the Flare tool). You can specify height and width values for the object in the same way as you would draw in regular mode, but the object is drawn in perspective in this case. Also, the values represent real world dimensions of the objects.

Note: While drawing in perspective, you can use the regular shortcuts available for drawing objects such as Shift / Alt+drag (Windows) or Option+drag (Mac OS).

While drawing in perspective, objects can be snapped to grid lines of the active plane. An object snaps to the grid lines within 1/4th distance of the cell size.

You can enable or disable the Snap to Grid option from View > Perspective Grid > Snap to Grid. This option is enabled by default.

For a video on drawing artwork in perspective, see www.adobe.com/go/lrvid5211_ai_en.

Attach objects to perspective

If you have already created objects, Illustrator provides the option to attach objects to an active plane on the perspective grid.

To add an object to the left, right, or horizontal grid:

- 1 Select the active plane on which you want to place the object. You can select the active plane using 1, 2, or 3 keyboard shortcut command or by clicking on one of the faces of the cube in the Perspective Grid Widget.
- 2 Click Object > Perspective > Attach to Active Plane.

Note: Using the Attach to Active Plane command does not affect the appearance of the object.

For a video on mapping artwork to perspective, see www.adobe.com/go/lrvid5212_ai_en.

Release objects with perspective

If you want to release an object with a perspective view, click Object > Perspective > Release with Perspective option. The selected object is released from the associated perspective plane and is available as a normal artwork.

Note: Using the Release with Perspective command does not affect the appearance of the object.

Bringing objects in perspective

When you bring an existing object or artwork into perspective, the appearance and scale of the selected object changes. To bring regular objects into perspective, do the following:

- 1 Select the object using the Perspective Selection tool.
- 2 Select the active plane on which you want to place the object by using the Plane Switching widget or using the keyboard shortcut 1 (left plane), 2 (horizontal plane), 3 (right plane).
- 3 Drag-and-drop the object at the required location.

Selecting objects in perspective

Use the Perspective Selection tool to select objects in perspective. The Perspective Selection tool provides a marquee to select objects using the active plane settings.

You can select between normal marquee and the perspective marquee after starting to drag using the Perspective Selection tool and then switch between different planes of the grid using 1, 2, 3, or 4 keys.

Transforming objects

Moving objects

To move objects in perspective, switch to the Perspective Selection tool (Shift+V) and then either use the arrow keys or the mouse to drag-and-drop objects.

Note: During the drag loop while moving the objects, changing the plane using the respective keyboard shortcut changes the object's plane.

You can also move objects in perpendicular direction to the current object location. This technique is useful when creating parallel objects such as the walls of a room. For this movement:

- 1 Select the object using the Perspective Selection tool.
- 2 Keeping the number 5 key pressed, drag the object to the required position. This action moves the object parallel to its current location. Using Alt (Windows) or Option (Mac OS) along with the number 5 key while moving, duplicates the object at the new location without changing the original object. In Draw Behind mode, this action creates the object behind the original object.

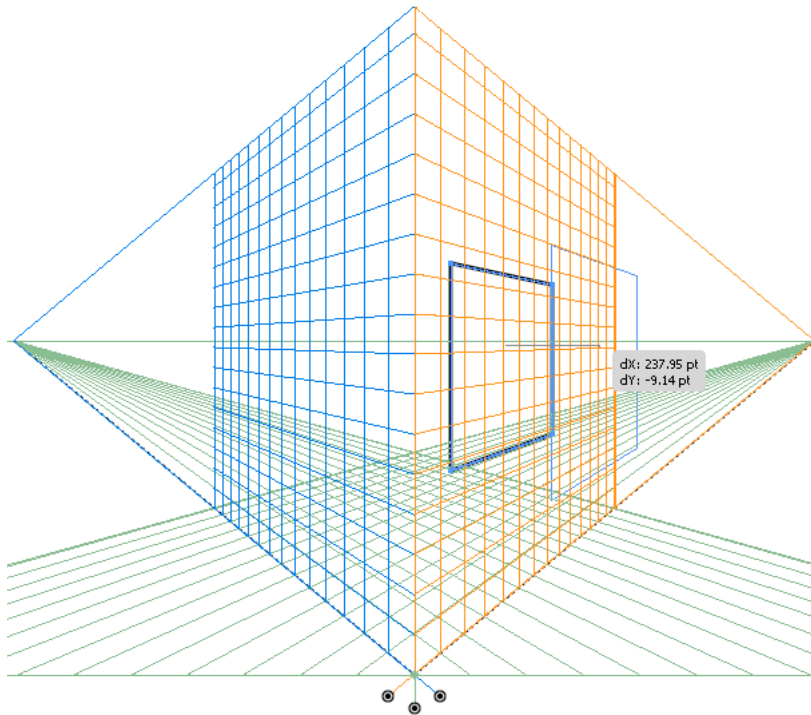

Moving a rectangle in perpendicular to its initial position

Note: The arrow keys do not work when you move objects in perpendicular.

Use the keyboard shortcut, Alt+drag (Windows) or Option+drag (Mac OS) to copy the object. To constrain the movement in perspective, press Shift+drag. To specify a precise location where you need to move the object during perpendicular movement, see “[Precise perpendicular movement](#)” on page 89.

You can also use the Transform Again command (Object > Transform > Transform Again) or the keyboard shortcut Ctrl+D (Windows) or Cmd+D (Mac OS) to move objects in perspective. This option also works when you move object in perpendicular direction.

Note: The keyboard shortcut 5 for perpendicular movement and the keyboard shortcuts 1,2, and 3 for plane switching while drawing or moving objects, work only from the main keyboard and not from the extended numeric keypad.

Precise perpendicular movement

To move objects in precise perpendicular movement, double-click the required plane widget using the Perspective Selection tool. For example, double-click the right plane widget to set the options in the Right Vanishing Plane dialog box.

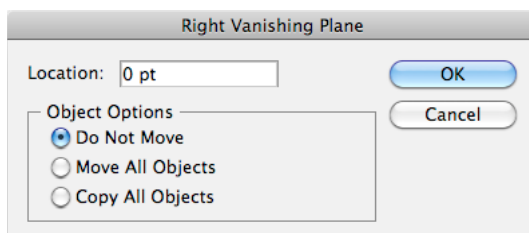

Setting options for perpendicular movement of all objects on the selected grid plane

For precise perpendicular movement, for all objects:

- 1 In the Location box, specify the location where the objects need to be moved. By default, the current location of objects is displayed in the dialog box.
- 2 Select from the following movement options for objects:

Do Not Move If this option is selected, the object does not move when the grid is repositioned.

Move All Objects If you select this option, then all the objects on the plane move with the grid movement.

Copy All Objects If you select this option, then all the objects on the plane are copied on the plane.

To move a selected object in precise perpendicular movement, select the object and then double-click the required plane widget. In this case, the following dialog box is displayed:

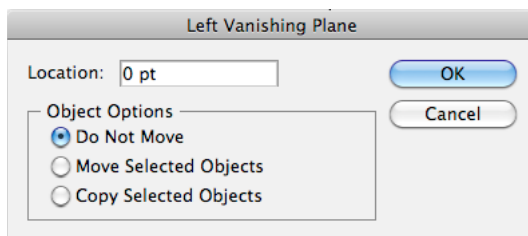

Setting options for perpendicular movement of selected objects

Perpendicular movement by dragging grid planes

You can also move objects in perpendicular direction by dragging the grid plane using grid plane controls. When you move an object in perpendicular direction, the object is placed parallel to its existing or current location.

To move an object parallel to its current position:

- 1 Select the Perspective Selection tool from the Tools panel or by pressing Shift+V.
- 2 Press Shift and drag the grid plane control depending on the grid plane where the object is placed.

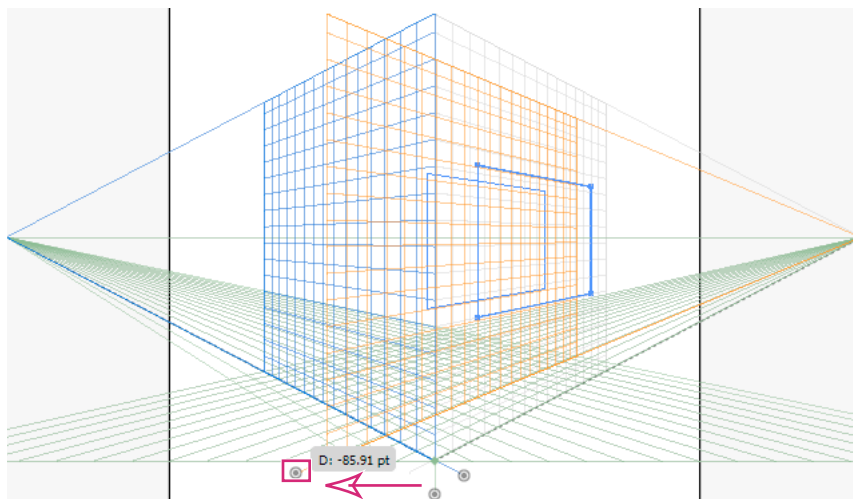

Moving a rectangle in perpendicular by dragging the right grid plane

To create a copy of the object parallel to its current position:

- 1 Select the Perspective Selection tool from the Tools panel or by pressing Shift+V.

- 2 Press Alt and drag (Windows) or Option and drag (Mac OS) the grid plane control depending on the grid plane where the object is placed.

Automatic plane positioning

The automatic plane positioning feature allows you to create objects by inferring the height or depth of the object. For example, to draw a cube, the height of the top face of the cube must be known. With automatic plane positioning, perspective grid automatically adjusts the horizontal grid plane to match the height of the top face of the cube.

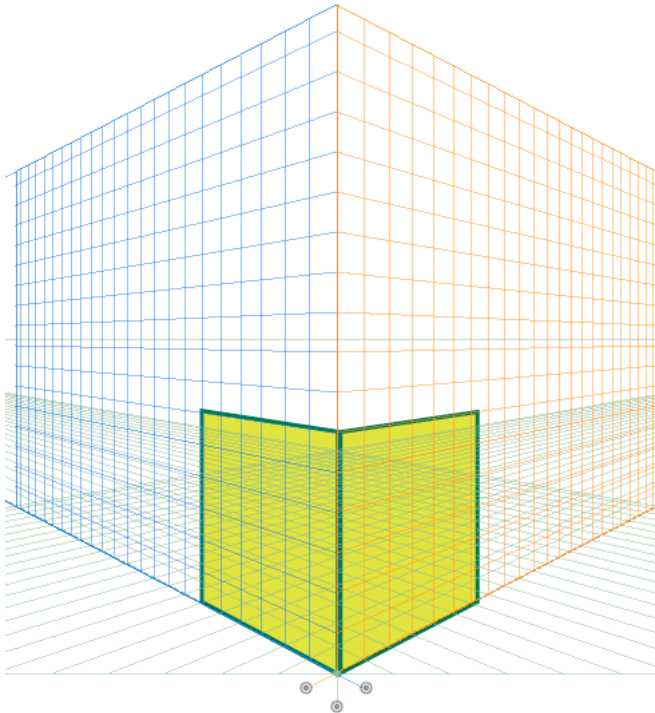

Two faces of a cube

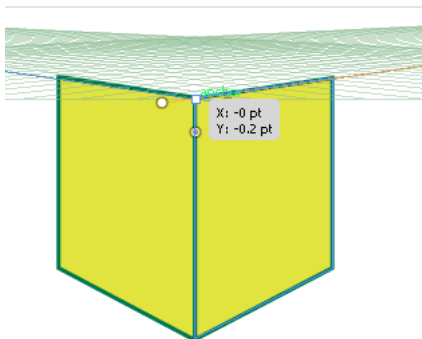

Horizontal grid plane is adjusted to the height of left face of the cube when horizontal grid plane is selected and you place the pointer on the anchor point using Perspective Selection tool and press Shift. The other grid planes are hidden temporarily.

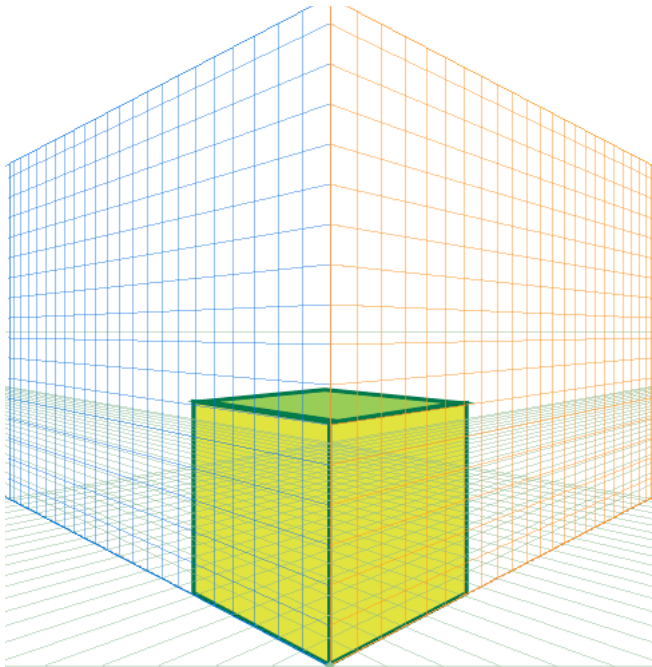

After creating the top face of the cube using the rectangle tool, the grid resumes its original state

Before drawing or placing objects, the object height can be inferred from:

- Other objects by going to one of the anchor points (getting the anchor label) and pressing Shift, which temporarily hides other planes.
- Grid lines by going to the intersection point and pressing the Shift key. Changing plane in this state brings that plane to the selected offset.

Once the object is drawn or placed, the inference mode is reset and all planes are restored to normal visibility.

Using the automatic plane positioning options, you can select to move the active plane temporarily when you mouse over the anchor point or gridline intersection point by pressing the Shift key.

The automatic plane positioning options are available in the Perspective Grid Options dialog box. To display this dialog box, double-click the Perspective Grid tool icon in the Tools panel.

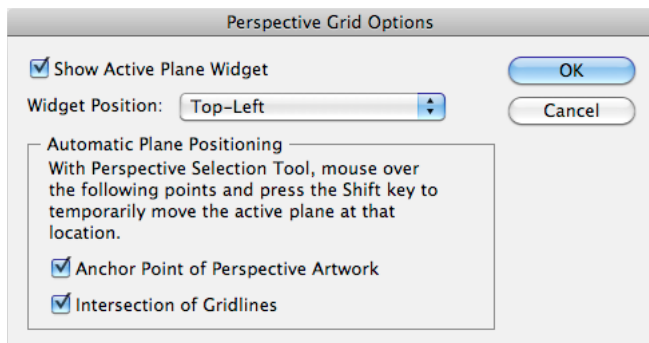

Automatic Plane Positioning options

Move plane to match object

When you want to draw or bring objects in perspective at the same depth or height as an existing object, select the existing object in perspective and click Object > Perspective > Move Plane to Match Object to bring the corresponding grid to the desired height or depth. You can now draw or bring new objects in perspective.

Scale objects in perspective

You can scale objects in perspective using the Perspective Selection tool. While scaling objects in perspective, the following rules apply:

- Scaling is done in the object's plane. When you scale an object, the height or distance is scaled based on the object's plane and not the current or active plane.
- For multiple objects, scaling is done for objects that are on the same plane. For example, if you select multiple objects on the right and left plane, then all the objects that are on the same plane as the object whose bounding box is used for scaling, are scaled.
- Objects that have been moved perpendicularly, are scaled on their respective plane and not the current or active plane.

Adding text and symbols in perspective

You cannot directly add text and symbols to a perspective plane, when the grid is visible. However, you can bring text or symbols into perspective after creating them in normal mode.

To bring text or symbols in perspective, do the following:

- 1 Select the existing text or symbol using the Perspective Selection Tool and drag it to the required position on the active plane, while the grid is visible.
- 2 The Edit Text option is available in the Control panel and under the Object > Perspective menu. In addition, you can edit text in isolation mode or by double-clicking the text object.

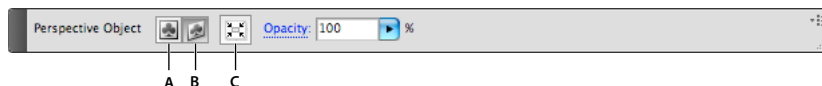

Control Panel with Edit Text options
A. Edit Text B. Edit Perspective C. Isolate Selected Object

The Edit Symbol option is also available in the Control panel and under the Object > Perspective menu. In addition, you can edit a symbol in isolation mode or by double-clicking the object.

 Depending on whether you are editing a symbol or text, the options in the Control panel change to Edit Symbol or Edit Text.

A symbol instance in perspective is the same as an expanded symbol instance. You can edit a symbol definition just as you would edit the symbol definition of a flat symbol instance. However, a symbol definition cannot contain art types that are not supported in perspective such as raster (images), non-native art, envelope, legacy type, and gradient mesh.

Note: Functionalities such as replacing a symbol, breaking link when expanding the a symbol instance, and reset transformation do not work on symbols in perspective.

As a workaround to replacing a symbol instance, you can Alt+drag (Windows) or Option+drag (Mac OS) a symbol instance in perspective and leave it over the symbol in the Symbols panel. However, make a copy of the symbol before replacing the symbol instance because when you drag the symbol instance, the previous symbol instance is permanently deleted from your document.

You can edit or modify text in the same way as is done in the normal mode. For more information, see “Creating text” on page 305.

Perspective Grid settings

You can configure the Perspective Grid settings using View > Perspective Grid. The options available include:

Show Rulers This option shows the ruler division only along the true height line. The gridline every determines the ruler division.

Snap to Grid This option allows snapping to gridlines while bringing in perspective, moving, scaling, and drawing in perspective.

Lock Grid This option restricts the grid movement and other grid editing using the Perspective Grid tool. Only the visibility and the plane position can be changed.

Lock Station Point When the Lock Station Point option is selected, moving one vanishing point moves the other vanishing point in sync with the movement. If not checked, then the movement is independent and the station point also moves.

Tracing artwork with Live Trace

Trace artwork

If you want to base a new drawing on an existing piece of artwork, you can trace it. For example, you can create a graphic based on a pencil sketch drawn on paper or on a raster image saved in another graphics program by bringing the graphic into Illustrator and tracing over it.

The easiest way to trace artwork is to open or place a file into Illustrator and automatically trace the artwork with the Live Trace command. You can control the level of detail and how the tracing is filled. When you are satisfied with the tracing results, you can convert the tracing to vector paths or a Live Paint object.



Before and after tracing a bitmap image with the Live Trace command

For a video on using Live Trace, see www.adobe.com/go/vid0043. For examples on using a template layer for tracing, see the following tutorials: www.adobe.com/go/learn_ai_tutorials_templatelayer_en and www.adobe.com/go/learn_ai_tutorials_elliptical_gradients_en.

Automatically trace artwork using Live Trace

- 1 Open or place a file to use as the source image for the tracing.
- 2 With the source image selected, do one of the following:
 - To trace the image using a tracing preset, click the Tracing Presets and Options button  in the Control panel, and select a preset.

Drawing

- To trace the image using the default tracing options, click Live Trace in the Control panel, or choose Object > Live Trace > Make.
 - To set tracing options before you trace the image, click the Tracing Presets and Options button  in the Control panel, and choose Tracing Options. Alternatively, choose Object > Live Trace > Tracing Options. Set tracing options, and then click Trace.
- 3 (Optional) Adjust the results of the tracing.
 - 4 (Optional) Convert the tracing to paths or to a Live Paint object.

Tracing options

Preset Specifies a tracing preset.

Mode Specifies a color mode for the tracing result.

Threshold Specifies a value for generating a black and white tracing result from the original image. All pixels lighter than the Threshold value are converted to white, all pixels darker than the Threshold value are converted to black. (This option is available only when Mode is set to Black and White.)

Palette Specifies a palette for generating a color or grayscale tracing from the original image. (This option is available only when Mode is set to Color or Grayscale.)

To let Illustrator determine the colors in the tracing, select Automatic. To use a custom palette for the tracing, select a swatch library name. (The swatch library must be open in order for it to appear in the Palette menu.)

Max Colors Specifies a maximum number of colors to use in a color or grayscale tracing result. (This option is available only when Mode is set to Color or Grayscale and when panel is set to Automatic.)

Output To Swatches Creates a new swatch in the Swatches panel for each color in the tracing result.

Blur Blurs the original image before generating the tracing result. Select this option to reduce small artifacts and smooth jagged edges in the tracing result.

Resample Resamples the original image to the specified resolution before generating the tracing result. This option is useful for speeding up the tracing process for large images but can yield degraded results.

Note: The resample resolution is not saved when you create a preset.

Fills Creates filled regions in the tracing result.

Strokes Creates stroked paths in the tracing result.

Max Stroke Weight Specifies the maximum width of features in the original image that can be stroked. Features larger than the maximum width become outlined areas in the tracing result.

Min Stroke Length Specifies the minimum length of features in the original image that can be stroked. Features smaller than the minimum length are omitted from the tracing result.

Path Fitting Controls the distance between the traced shape and the original pixel shape. Lower values create a tighter path fitting; higher values create a looser path fitting.

Minimum Area Specifies the smallest feature in the original image that will be traced. For example, a value of 4 specifies that features smaller than 2 pixels wide by 2 pixels high will be omitted from the tracing result.

Corner Angle Specifies the sharpness of a turn in the original image that is considered a corner anchor point in the tracing result. For more information on the difference between a corner anchor point and a smooth anchor point, see “[About paths](#)” on page 50.

Raster Specifies how to display the bitmap component of the tracing object. This view setting is not saved as part of the tracing preset.

Vector Specifies how to display the tracing result. This view setting is not saved as part of the tracing preset.

 *Select Preview in the Tracing Options dialog box to preview the result of the current settings. To set the default tracing options, deselect all objects before you open the Tracing Options dialog box. When you're finished setting options, click Set Default.*

For a video on using Live Trace, see www.adobe.com/go/vid0043. For a tutorial on tweaking Live Trace options for the best possible results, see www.adobe.com/go/learn_ai_tutorials_livetrace_en.



Change the display of a tracing object

A tracing object is made up of two components: the original source image and the tracing result (which is the vector artwork). By default, only the tracing result is visible. However, you can change the display of both the original image and the tracing result to best suit your needs.

- 1 Select the tracing object.

 *By default, all tracing objects are named "Tracing" in the Layers panel.*

- 2 Do any of the following:

- To change the display of the tracing result, click the Vector View button  in the Control panel or choose Object > Live Trace, and select a display option: No Tracing Result, Tracing Result, Outlines, or Outlines With Tracing.
- To change the display of the source image, click the Raster View button  in the Control panel or choose Object > Live Trace, and select a display option: No Image, Original Image, Adjusted Image (which displays the image with any adjustments that are applied during tracing), or Transparent Image.

Note: In order to view the source image, you must first change the Vector View to No Tracing Result or Outlines.

Adjust the results of a tracing object

Once you create a tracing object, you can adjust the results at any time.

- 1 Select the tracing object.

- 2 Do any of the following:

- Set basic options in the Control panel.
- Click the Tracing Options Dialog button  in the Control panel to view all tracing options. Alternatively, choose Object > Live Trace > Tracing Options. Adjust the options, and click Trace.

 *Use tracing presets to quickly change the results of a tracing.*

Specify the colors used for tracing

- 1 Create a swatch library that contains the colors you want to use in the tracing.
- 2 Make sure that the swatch library is open, and click the Tracing Options Dialog button  in the Control panel. Alternatively, choose Object > Live Trace > Tracing Options.
- 3 Select the swatch library name from the Palette menu, and click Trace.

More Help topics

[“Create a swatch library”](#) on page 124

Use a tracing preset

Tracing presets provide pre-specified tracing options for specific types of artwork. For example, if you’re tracing an image that you plan to use as a technical drawing, choose the Technical Drawing preset. All the tracing options change for optimal tracing of a technical drawing: color is set to black and white, blur is set to 0 px, stroke width is limited to 3 px, and so on.

Specify a preset

- Choose Object > Live Trace > Tracing Options. (Alternatively, select a tracing object, and click the Tracing Options Dialog button  in the Control panel.) Set tracing options for the preset, and click Save Preset. Enter a name for the preset, and click OK.
- Choose Edit > Tracing Presets. Click New, set tracing options for the preset, and click Done.



To base a new preset on an existing preset, select the preset, and click New.

Edit or delete a preset

- 1 Choose Edit > Tracing Presets.
- 2 Select the preset, and click Edit or Delete.

Note: You can’t edit or delete the default presets (default presets appear in brackets []). However, you can make an editable copy of a default preset by selecting the preset and clicking New.

Share presets with other users

- 1 Choose Edit > Tracing Presets.
- 2 Do one of the following:
 - Click Export to save your presets to a file.
 - Click Import to load presets from a file.

Convert a tracing object to a Live Paint object

When you are satisfied with the results of a tracing, you can convert the tracing object to paths or to a Live Paint object. This final step allows you to work with the tracing as you do other vector artwork. Once you convert the tracing object, you can no longer adjust the tracing options.

- 1 Select the tracing object.
- 2 Do one of the following:
 - To convert the tracing to paths, click Expand in the Control panel or choose Object > Live Trace > Expand. Use this method if you want to work with the components of the traced artwork as individual objects. The resulting paths are grouped together.
 - To convert the tracing to paths while preserving the current display options, choose Object > Live Trace > Expand As Viewed. For example, if the display options are set to Outlines for the tracing result, then the expanded paths will be outlines only (rather than filled and stroked). In addition, a snapshot of the tracing with its current display options is preserved and grouped with the expanded paths. Use this method if you want to preserve the tracing image as a guide for the expanded paths.

- To convert the tracing to a Live Paint object, click Live Paint in the Control panel or choose Object > Live Trace > Convert To Live Paint. Use this method if you want to apply fills and strokes to the traced artwork using the Live Paint Bucket tool.



To create a tracing and convert the tracing object in one step, choose Object > Live Trace > Make And Expand or Object > Live Trace > Make And Convert To Live Paint.

For a video on tracing, see www.adobe.com/go/vid0043.

More Help topics

“[About paths](#)” on page 50

“[About Live Paint](#)” on page 160

Release a tracing object



If you want to discard a tracing but keep the original placed image, you can release the tracing object.

- 1 Select the tracing object.
- 2 Choose Object > Live Trace > Release.

Manually trace artwork using template layers

Template layers are locked, nonprinting layers that you can use to manually trace images. Template layers are dimmed by 50% so you can easily see any paths you draw in front of the layer. You can create template layers when you place an image or from existing layers.

- 1 Do one of the following:
 - To place an image as a template layer for tracing, choose File > Place, select the EPS, PDF, or raster image file you want to trace, select Template, and then click Place. A new template layer appears below the current layer in the panel.
 - To trace an existing image, make sure the image is in its own layer, double-click the layer in the Layers panel, select Template, and click OK; alternatively, select the layer and choose Template from the panel menu.

The eye icon  is replaced by the template icon , and the layer is locked.

- 2 Trace over the file using the Pen tool or the Pencil tool.
- 3 To hide the template layer, choose View > Hide Template. Choose View > Show Template to see it again.
- 4 To turn a template layer into a regular layer, double-click the template layer in the Layers panel, deselect Template, and click OK.

Symbols

About symbols

A *symbol* is an art object that you can reuse in a document. For example, if you create a symbol from a flower, you can then add *instances* of that symbol multiple times to your artwork without actually adding the complex art multiple times. Each symbol instance is linked to the symbol in the Symbols panel or to a symbols library. Using symbols can save you time and greatly reduce file size.

Symbols also provide excellent support for SWF and SVG export. When you export to Flash, you can set the symbol type to MovieClip. Once in Flash, you can choose another type if necessary. You can also specify 9-slice scaling in Illustrator so that the symbols scale appropriately when used for user interface components.

Note: For information on using symbols in Flash, see *Flash Help*. For a video on using symbols effectively, see www.adobe.com/go/lrvid5204_ai_en.

After you place a symbol, you can edit the symbol's instances on the artboard and, if you want, redefine the original symbol with the edits. The symbolism tools let you add and manipulate multiple symbol instances at once.

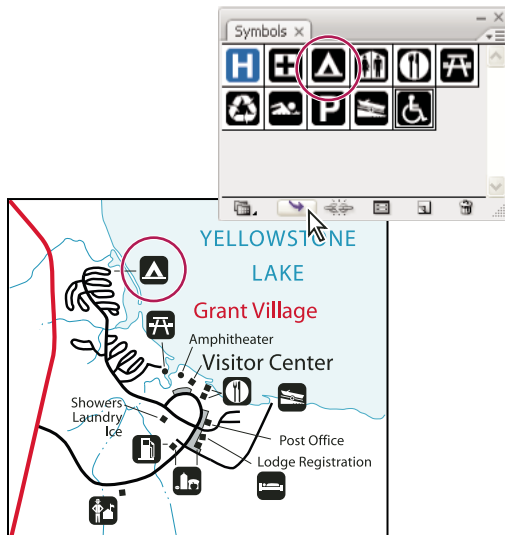

Artwork with symbol instances

Symbols panel overview

You can use the Symbols panel (Window > Symbols) or the Control panel to manage the symbols for a document. The Symbols panel contains a variety of preset symbols. You can add symbols from symbol libraries or libraries that you create.

Change the display of symbols in the panel

- 1 Select a view option from the panel menu: Thumbnail View to display thumbnails, Small List View to display a list of named symbols with a small thumbnail, or Large List View to display a list of named symbols along with a large thumbnail.
- 2 Drag the symbol to a different position. When a black line appears in the desired position, release the mouse button.
- 3 Select Sort By Name from the panel menu to list the symbols in alphabetical order.

Duplicate a symbol in the panel

Duplicating or copying a symbol in the Symbols panel is an easy way to create a new symbol using an existing symbol instance.

To create a copy of a symbol, select the symbol in the Symbols panel and choose Duplicate Symbol from the panel menu, or drag the symbol onto the New Symbol button.

Note: If you want to duplicate a symbol instance on the artboard, for example, if you have scaled and rotated a symbol and want to add another instance with the same scale and rotation, duplicate the instance. (See “[Work with symbol instances](#)” on page 102.)

Rename a symbol

- 1 To rename the symbol, select the symbol in the Symbols panel, choose Symbol Options from the panel menu, and then type a new name in the Symbol Options dialog box.
- 2 To rename a symbol instance, select a symbol instance in the artwork, and then type a new name in the Instance Name text box in the Control panel.

Symbol registration point

The symbol registration point in Illustrator is similar to Adobe Flash Professional. A registration point is the origin of the symbol definition art. This feature provides better interoperability between Illustrator and Flash.

When you create a symbol, you can choose the registration point from any of the 8-point across boundaries or center of the symbol bounding box. The registration point is visible as a crosshair symbol in Symbol edit mode and in normal mode when the symbol instance is selected. In isolation mode, you can snap your artwork with registration point mark.

In the Transform panel menu (flyout menu), the Use Registration Point for Symbol option is selected by default. Coordinates of the registration point are visible in the Transform panel when symbol instance is selected. All transformations of symbol instances correspond to the registration point of the symbol definition art.

The transformations applied on the symbol instance can be reset using the Reset Transformation option. For details see “[Reset transformations](#)” on page 104.

Place a symbol

- 1 Select a symbol in the Symbols panel or a symbol library.
- 2 Do one of the following:
 - Click the Place Symbol Instance button  in the Symbols panel to place the instance in the center of the artboard.
 - Drag the symbol to the artboard where you want it to appear.
 - Choose Place Symbol Instance from the Symbols panel menu.

Note: A single symbol placed anywhere in your artwork (as opposed to existing only in the panel) is called an instance.

Create a symbol

- 1 Select the artwork you want to use as a symbol.
- 2 Do one of the following:
 - Click the New Symbol button  in the Symbols panel.

- Drag the artwork to the Symbols panel.
- Choose New Symbol from the panel menu.

Note: By default, the selected artwork becomes an instance of the new symbol. If you don't want the artwork to become an instance, press Shift as you create the new symbol. In addition, if you don't want the New Symbol dialog box to open when you create a new symbol, press Alt (Windows) or Option (Mac OS) as you create the symbol and Illustrator will use a default name for the symbol, such as New Symbol 1.

- 3 In the Symbol Options dialog box, type a name for the symbol.
- 4 Select the symbol type as Movie Clip or Graphic. If you plan to export the symbols to Flash, do the following:
 - Select Movie Clip for type. Movie Clip is the default symbol type in Flash and in Illustrator.
 - Specify a location on the Registration grid where you want to set the symbol's anchor point. The location of the anchor point affects the position of the symbol within the screen coordinates.
 - Select Enable Guides For 9-Slice Scaling if you want to utilize 9-Slice scaling in Flash.
- 5 Select the Align to Pixel Grid option to apply the pixel-align property to the symbol. For more information, see ["Aligning symbols to pixel grid"](#) on page 60.

You can create symbols from most Illustrator objects, including paths, compound paths, text objects, raster images, mesh objects, and groups of objects. However, you cannot create a symbol from linked art or some groups, such as groups of graphs.

Note: For a video on using symbols effectively between Illustrator and Flash, see www.adobe.com/go/vid0198.

Add sublayers for symbols

Symbols now have an independent layer hierarchy, which is maintained when you expand symbols. You can create sublayers for symbols in symbol editing mode.

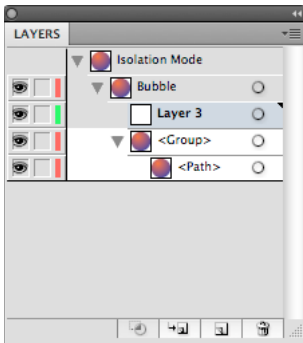

Ability to create sublayers for symbols in edit mode

Paste Remember Layers option is honored when you paste content in symbol editing mode.

Use 9-slice scaling

You can use 9-slice scaling (scale-9) to specify component-style scaling for graphic style and movie clip symbols. This type of scaling lets you create movie clip symbols that scale appropriately for use as user interface components, as opposed to the type of scaling typically applied to graphics and design elements.

The symbol is conceptually divided into nine sections with a grid-like overlay, and each of the nine areas is scaled independently. To maintain the visual integrity of the symbol, corners are not scaled, while the remaining areas of the image are scaled (as opposed to being stretched) larger or smaller, as needed.

The 9-slice scaling grid is visible only in isolation mode. By default, the grid's guides are placed at 25% (or 1/4) of the symbol's width and height from the edge of the symbol, and appear as dotted lines superimposed on the symbol.

Note: For more information on using 9-slice scaling in Flash, see *Flash Help*. For videos on using 9-slice scaling in Illustrator, see www.adobe.com/go/lrvid5210_ai_en.

In Illustrator, you can create 9-slice grid for symbols with rotation, shear, and complex transformations. When you scale a symbol, all the nine areas of the symbol can be scaled independently.

Enable 9-slice scaling



- 1 Select the symbol on the artboard or in the Symbols panel and choose Symbol Options from the panel menu.
- 2 In the Symbol Options dialog box, select Movie Clip or Graphic for Type, and then select Enable Guides For 9-Slice Scaling.

Note: You can also enable this option in the Symbol Options dialog box when creating a new symbol.

Edit the 9-slice scaling grid for a symbol

- 1 To edit the scaling grid for a symbol, open the symbol in isolation mode by doing one of the following:
 - Double-click the symbol in the Symbols panel.
 - Select the symbol in the Symbols panel and choose Edit Symbol from the panel menu.
- 2 To edit the scaling grid for a symbol instance, open the instance in isolation mode by doing one of the following:
 - Double-click the symbol instance on the artboard.
 - Select the symbol instance on the artboard and click Edit Symbol in the Control panel.
- 3 Move the pointer over any of the four guides. When the pointer changes to the move pointer, drag the guide.

Note: Scaling still occurs if you move a guide away from the symbol boundaries (thus dividing the symbol into less than 9 slices). The symbol scales according to the slice in which it falls.

- 4 Exit isolation mode by clicking the Exit Isolation Mode button  at the upper-left corner of the artboard or in the Control panel .

Work with symbol instances

You can move, scale, rotate, shear (or skew), or reflect symbol instances in the same way you can other objects. You can also perform any operation from the Transparency, Appearance, and Graphic Styles panels and apply any effect from the Effect menu. However, if you want to modify the individual components of a symbol instance, you must first *expand* it. Expanding breaks the link between the symbol and the symbol instance and converts the instance to regular artwork.

For videos on selecting and aligning objects, including symbols, see www.adobe.com/go/vid0034 and www.adobe.com/go/vid0035.



Note: The options to “*Replace a symbol instance with a different symbol*” on page 103, *break link when you “Expand a symbol instance”* on page 103, and “*Reset transformations*” on page 104 do not work on symbols in perspective.

More Help topics

“[Expand objects](#)” on page 210

Modify a symbol instance

After you modify a symbol instance, you can redefine the original symbol in the Symbols panel. When you redefine a symbol, all existing symbol instances take on the new definition.

- 1 Select an instance of the symbol.
- 2 Click the Break Link To Symbol button  in the Symbols panel or Control panel.
- 3 Edit the artwork.
- 4 (Optional) do one of the following:
 - To replace the parent symbol with this edited version, Alt-drag (Windows) or Option-drag (Mac OS) the modified symbol on top of the old symbol in the Symbols panel. The symbol is replaced in the Symbols panel and is updated in the current file.
 - To create a new symbol with this edited version, drag the modified symbol to the Symbols panel or click New Symbol  in the Symbols panel.

Expand a symbol instance

- 1 Select one or more symbol instances.
- 2 Do one of the following:
 - Click the Break Link To Symbol button  in the Symbols panel or Control panel, or choose Break Link To Symbol from the panel menu.
 - Choose Object > Expand, and then click OK in the Expand dialog box.

Illustrator places the components of the symbol instance in a group. Once expanded, you can edit the artwork.

Duplicate a symbol instance on the artboard

If you've scaled, rotated, sheared (or skewed), or reflected a symbol instance and you want to add more instances with exactly those same modifications, duplicate the modified instance.

- 1 Select the symbol instance.
- 2 Do one of the following:
 - Alt-drag (Windows) or Option-drag (Mac OS) the symbol instance to another location on the artboard.
 - Copy and paste the symbol instance.

Note: If you want to duplicate a symbol in the Symbols panel, for example to create a new symbol based on an existing symbol, duplicate the symbol, not the instance. (See [“Symbols panel overview”](#) on page 99.)

Replace a symbol instance with a different symbol

- 1 Select the symbol instance on the artboard.
- 2 Do one of the following:
 - Choose a new symbol from the Replace menu in the Control panel.
 - Select a new symbol in the Symbols panel, and choose Replace Symbol from the Symbols panel menu.

Note: This option does not work for symbols in perspective. See [“Adding text and symbols in perspective”](#) on page 93.

Select all instances of a symbol in the document

Select a symbol in the Symbols panel, and then choose Select All Instances from the panel menu.



Reset transformations

To reset any transformations to symbols, select the symbol and click the Reset button in the Control panel. You can also select the Reset Transformation option from the Symbols panel menu (flyout menu).

Edit or redefine a symbol

You can edit a symbol by changing the symbol's artwork or you can redefine the symbol by replacing it with new artwork. Editing and redefining a symbol changes the appearance of the symbol in the Symbols panel, as well as all instances of the symbol on the artboard.

Edit a symbol

- 1 Do one of the following to open the symbol in isolation mode:
 - Select an instance of the symbol and click Edit Symbol in the Control panel. When the Alert box opens, click OK.
 - Double-click an instance of the symbol. When the Alert box opens, click OK.
 - Double-click a symbol in the Symbols panel. A temporary instance of the symbol appears in the center of the artboard.
- 2 Edit the artwork.
- 3 Exit isolation mode by clicking the Exit Isolation Mode button  at the upper-left corner of the artboard or in the Control panel  or pressing Esc.

You can also apply the pixel-align property to a symbol. For more information, see “[Aligning symbols to pixel grid](#)” on page 60.

Redefine a symbol with different artwork

- 1 Select the artwork that you want to use to redefine an existing symbol. Make sure to select original artwork and not a symbol instance.
- 2 In the Symbols panel, click the symbol you want to redefine, and choose Redefine Symbol from the panel menu.

Note: The selected artwork automatically becomes an instance of the symbol. If you don't want the selected artwork to become a symbol instance, press Shift as you choose Redefine Symbol from the panel menu.

 If you are not able to locate the panel menu, see “[Use panel menus](#)” on page 13.

Symbol libraries

Symbol libraries are collections of preset symbols. When you open a symbol library, it appears in a new panel (not the Symbols panel).

You select, sort, and view items in a symbol library the same as you do in the Symbols panel. However, you can't add items to, delete items from, or edit the items in symbol libraries.

Open symbol libraries

- ❖ Do one of the following:
 - Choose Window > Symbol Libraries > [symbol].
 - Choose Open Symbol Library in the Symbols panel menu, and choose a library from the list that appears.
 - Click the Symbols Library Menu button on the Symbols panel, and choose a library from the list that appears.

 *To automatically open a library when you start Illustrator, choose Persistent from the library's panel menu.*

Move symbols from a library into the Symbols panel

A symbol is automatically added to the Symbols panel whenever you use it in a document.

- ❖ Click a symbol in a library.

Create symbol libraries

- 1 To add all the symbols from a library, Shift select all the symbols and choose Add to Symbols from the Symbol Library option menu. Add the symbols you want in the library to the Symbols panel, and delete any symbols you don't want.

 *To select all symbols that aren't used in a document, choose Select All Unused from the Symbols panel menu.*

- 2 Choose Save Symbol Library from the Symbols panel menu.
- 3 Save the new library to the default Symbols folder. The library name will automatically appear in the User Defined submenu of the Symbol Libraries and Open Symbol Library menu.

If you save the library to a different folder, you can open it by choosing Open Symbol Library > Other Library from the Symbols panel menu. Once you open it using this process, it will appear in the Symbol Libraries submenu with the other libraries.

Import a symbol library from another document

- 1 Choose Window > Symbol Libraries > Other Library or choose Open Symbol Library > Other Library from the Symbols panel menu.
- 2 Select the file from which you want to import symbols, and click Open.
The symbols appear in a symbol library panel (not the Symbols panel).

Symbolism tools and symbol sets

About symbol sets

A *symbol set* is a group of symbol instances that you create with the Symbol Sprayer tool. You can create mixed sets of symbol instances by using the Symbol Sprayer tool with one symbol and then using it again with another symbol.

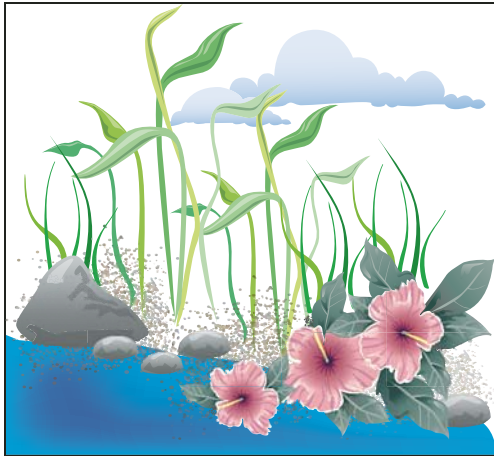

Artwork created with the symbolism tools

As you work with symbol sets, keep in mind that the symbolism tools affect only the symbol or symbols selected in the Symbols panel. For example, if you create a mixed symbol instance set that represents a meadow with grass and flowers, you can change the orientation of just the grass by selecting the grass symbol in the Symbols panel and then using the Symbol Spinner tool. To change the size of both the grass and the flowers, select both symbols in the Symbols panel and then use the Symbol Sizer tool.

***Note:** When you select a mixed symbol set on the artboard, the symbol instance most recently added to the set is automatically selected in the Symbols panel.*

Create symbol sets

The Symbol Sprayer acts like a particle sprayer—letting you add a large number of identical objects to the artboard at one time. For example, use the symbol sprayer to add hundreds of grass blades, wildflowers, bees, or snowflakes.

More Help topics

[“Symbolism tool gallery”](#) on page 22

[“Symbolism tool options”](#) on page 109

Spray sets of symbol instances onto artwork

- 1 Select a symbol in the Symbols panel, and then select the Symbol Sprayer tool .
- 2 Click or drag where you want the symbol instances to appear.

Add or delete symbol instances from an existing set

- 1 Select the existing symbol set.
- 2 Select the Symbol Sprayer tool  and a symbol in the Symbols panel.
- 3 Do one of the following:
 - To add symbol instances, click or drag where you want the new instances to appear.
 - To delete symbol instances, hold down Alt (Windows) or Option (Mac OS) as you click or drag where you want to remove instances.

Modify symbol instances in a symbol set

You use the symbolism tools to modify multiple symbol instances in a set. For example, you can disperse instances over a larger area using the Symbol Scruncher tool or gradually tinting the color of instances to make them look more realistic.

Although you can use symbolism tools on individual symbol instances, they are most effective when used on symbol sets. When working with individual symbol instances, most of these tasks are easily accomplished using the tools and commands you use on regular objects.

More Help topics

[“Symbolism tool gallery”](#) on page 22

[“Symbolism tool options”](#) on page 109

Change stacking order of symbol instances in a set

- 1 Select the Symbol Shifter tool .
- 2 Do one of the following:
 - To move symbol instances, drag in the direction you want the symbol instances to move.
 - To bring symbol instances forward, Shift-click the symbol instance.
 - To send symbol instances backward, hold down Alt (Windows) or Option (Mac OS) and Shift-click the symbol instance.

Gather or scatter symbol instances

- 1 Select the Symbol Scruncher tool .
- 2 Do one of the following:
 - Click or drag in the area where you want to pull the symbol instances toward each other.
 - Hold down Alt (Windows) or Option (Mac OS), and click or drag in the area where you want to push symbol instances away from each other.

Resize symbol instances

- 1 Select the Symbol Sizer tool .
- 2 Do one of the following:
 - Click or drag in the set where you want to increase the size of the symbol instances.
 - Hold down Alt (Windows) or Option (Mac OS), and click or drag where you want to decrease the size of the symbol instances.
 - Hold down Shift as you click or drag to preserve the density of the symbol instances while resizing.

Rotate symbol instances

- 1 Select the Symbol Spinner tool .
- 2 Click or drag in the direction you want the symbol instances to orient.

Stain symbol instances

Staining a symbol instance changes the hue toward the tint color, while preserving the original luminosity. (It works in the same way as the Tints and Shades colorization method of tinting brushes.) This method uses the luminosity of the original color and the hue of the colorization color to generate the resulting color. Consequently, colors with very high or very low luminosity change very little; black or white objects don't change at all.

 *To achieve a method of colorization that will also affect black and white objects, use the Symbol Styler tool with a graphic style that uses the desired fill color.*

- 1 In the Color panel, select the fill color that you want to use as the colorization color.
- 2 Select the Symbol Stainer tool  and do one of the following:
 - Click or drag over the symbol instances you want to stain with the colorization color. The amount of colorization gradually increases, and the symbol instance's color gradually changes to the colorization color.
 - Hold down Alt (Windows) or Option (Mac OS) as you click or drag to decrease the colorization amount and reveal more of the original symbol color.
 - Hold down Shift as you click or drag to keep the colorization amount constant, while gradually changing the color of the symbol instances to the colorization color.

Note: Using the Symbol Stainer tool results in increased file size and decreased performance. When memory or exported Flash/SVG file size is a concern, do not use this tool.

Adjust transparency of symbol instances

- 1 Select the Symbol Screener tool .
- 2 Do one of the following:
 - Click or drag where you want to increase the symbol's transparency.
 - Hold down Alt (Windows) or Option (Mac OS), and click or drag where you want to decrease the symbol's transparency.

Apply a graphic style to symbol instances

The Symbol Styler tool lets you apply or remove a graphic style from a symbol instance. You can control the amount and location of the application. For example, you can apply a style gradually so that some symbol instances display the style at full strength and others display the style at partial strength.

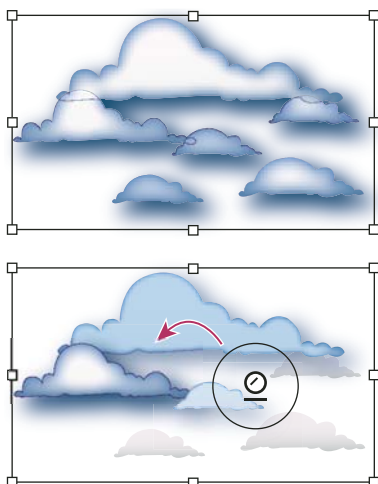

Graphic style applied at full strength (top) compared to graphic style applied at varying strengths (bottom)

 You can switch to the Symbol Styler tool when using any other symbolism tool by clicking a style in the Graphic Styles panel.

- 1 Select the Symbol Styler tool .
- 2 Select a style in the Graphic Styles panel, and do one of the following:
 - Click or drag where you want to apply the style to the symbol set. The amount of style applied to the symbol instances increases, and the style gradually changes.
 - Hold down Alt (Windows) or Option (Mac OS) as you click or drag to decrease the style amount and reveal more of the original, unstyled symbol.
 - Hold down Shift as you click or drag to keep the amount of style constant, while gradually changing the symbol instance style to the selected style.

***Note:** It is very important to perform steps 1 and 2 in the specified order. If you select a style while a tool other than the symbolism tool is selected, the style will apply immediately to the entire selected symbol instance set.*

Symbolism tool options

You access symbolism tool options by double-clicking a symbolism tool in the Tools panel.

General options, such as diameter, intensity, and density, appear at the top of the dialog box. Tool-specific options appear at the bottom of the dialog box. To switch to options for a different tool, click a tool icon in the dialog box.

General options The General options appear at the top of the Symbolism Tools Options dialog box regardless of which symbolism tool is selected.

- **Diameter** Specifies the tool's brush size.

 At any time while using a symbolism tool, press [to decrease the diameter or] to increase it.

- **Intensity** Specifies the rate of change (higher values equal faster changes), or select Use Pressure Pen to use the input from a tablet or pen instead of the Intensity value.
- **Symbol Set Density** Specifies an attraction value for the symbol set (higher values result in more densely packed symbol instances). This setting applies to an entire symbol set. If a symbol set is selected, the density changes for all symbol instances in the set, not just newly created instances.
- **Method** Specifies how the Symbol Scruncher, Sizer, Spinner, Stainer, Screener, and Styler tools adjust symbol instances.

Select User Defined to gradually adjust symbols in relation to the position of the cursor. Select Random to modify the symbols randomly in the area under the cursor. Select Average to gradually smooth out the symbol values.

- **Show Brush Size And Intensity** Displays the size as you use the tool.

Symbol Sprayer options The Symbol Sprayer options (Scrunch, Size, Spin, Screen, Stain, and Style) appear under the General options in the Symbolism Tools Options dialog box only when the Symbol Sprayer tool is selected, and control how new symbol instances are added to symbol sets. Each of these offers two choices:

- **Average** To add a new symbol with the average value of existing symbol instances within the brush radius. For example, an instance added to an area where the average existing symbol instance is 50% transparent will be 50% transparent; an instance added to an area with no instances will be opaque.

***Note:** The Average setting only takes into account other instances within the Symbol Sprayer tool's brush radius, which you set using the Diameter option. To see the radius as you work, select Show Brush Size And Intensity.*

- **User Defined** To apply specific preset values for each parameter: Scrunch (density) is based on the original symbol size; Size uses the original symbol size; Spin uses the mouse direction (or no orientation if the mouse doesn't move); Screen uses 100% opacity; Stain uses the current fill color and full tint amount; Style uses the current style.

Symbol Sizer options The Symbol Sizer options appear under the General options in the Symbolism Tools Options dialog box only when the Symbol Sizer tool is selected.

- **Proportional Resizing** Keeps each symbol instance shape uniform as you resize.
- **Resizing Affects Density** Moves symbol instances away from each other when they are scaled up and moves them toward each other when they are scaled down.

Drawing flares

The Flare tool creates flare objects with a bright center, a halo, and rays and rings. Use this tool to create an effect similar to a lens flare in a photograph.

Flares include a center handle and an end handle. Use the handles to position the flare and its rings. The center handle is in the bright center of the flare—the flare path begins from this point.

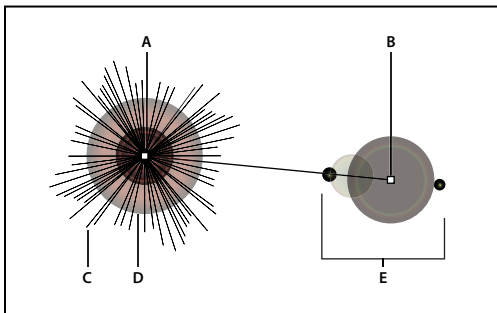

Components of a flare
A. Center handle B. End handle C. Rays (shown black for clarity) D. Halo E. Rings

To learn more about creating and editing flares, see this topic in web Help.

Important: Complete, updated Help is on the web. The application did not detect an Internet connection. For a complete version of this topic, click the link below or search complete Help at community.adobe.com/help.

Create a flare

The Flare tool creates flare objects with a bright center, a halo, and rays and rings. Use this tool to create an effect similar to a lens flare in a photograph.

Flares include a center handle and an end handle. Use the handles to position the flare and its rings. The center handle is in the bright center of the flare—the flare path begins from this point.

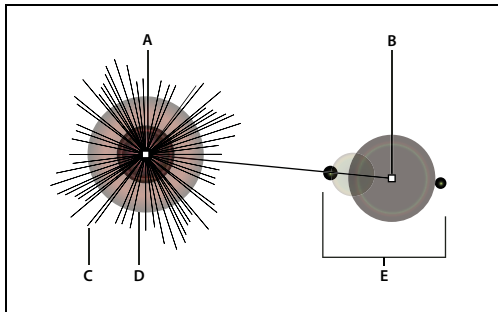

Components of a flare

A. Center handle B. End handle C. Rays (shown black for clarity) D. Halo E. Rings

More Help topics

[“Drawing tool gallery”](#) on page 18

Create a default flare

- 1 Select the Flare tool .
- 2 Press Alt (Windows) or Option (Mac OS), and click where you want the center handle of the flare to appear.

 *Flares often look best when drawn over existing objects.*

Draw a flare

- 1 Select the Flare tool.
- 2 Press the mouse button down to place the center handle of the flare, then drag to set the size of the center, the size of the halo, and to rotate the angle of the rays.

Before releasing the mouse, press Shift to constrain the rays to a set angle. Press Up Arrow or Down Arrow to add or subtract rays. Press Ctrl (Windows) or Command (Mac OS) to hold the center of the flare constant.

- 3 Release the mouse when the center, halo, and rays are as desired.
- 4 Press and drag again to add rings to the flare and place the end handle.

Before releasing the mouse, Press Up Arrow or Down Arrow to add or subtract rings. Press the tilde (~) key to randomly place the rings.

- 5 Release the mouse when the end handle is in the desired location.

Each element (center, halo, rings, and rays) in the flare is filled with color at different opacity settings.

Create a flare using the Flare Tool Options dialog box

- 1 Select the Flare tool, and click where you want to place the center handle of the flare.
- 2 In the Flare Tool Options dialog box, do any of the following options, and click OK:
 - Specify the overall diameter, opacity, and brightness of the flare’s center.
 - Specify the Growth of the halo as a percentage of the overall size, and specify the fuzziness of the halo (0 is crisp and 100 is fuzzy).
 - If you want the flare to contain rays, select Rays and specify the number of rays, the longest ray (as a percentage of the average ray), and the fuzziness of the rays (0 is crisp and 100 is fuzzy).

- If you want the flare to contain rings, select Rings and specify the distance of the path between the halo's center point (center handle) and the center point of the furthest ring (end handle), the number of rings, the largest ring (as a percentage of the average ring), and the direction or angle of the rings.

Edit a flare

Do any of the following:

- Select the flare, and double-click the Flare tool icon to open the Flare Tool Options dialog box. Change settings in the dialog box.



To reset a flare to the default values, hold down Alt (Windows) or Option (Mac OS), and click Reset.

- Select the flare and the Flare tool. Drag an endpoint—from either the center handle or the end handle—to change the length or direction of the flare.
- Select the flare, and choose Object > Expand. This makes the elements of the flare editable, like elements of blends.

More Help topics

[“Expand objects”](#) on page 210

Chapter 4: Color

About color

Applying colors to artwork is a common Adobe Illustrator task, and one that requires some knowledge of color models and color modes. When applying color to artwork, keep in mind the final medium in which the artwork will be published, so that you can use the correct color model and color definitions. Experimenting and applying color is easy using the feature-rich Swatches panel, Color Guide panel, and Edit Colors/Recolor Artwork dialog box in Illustrator.

Color models describe the colors we see and work with in digital graphics. Each color model, such as RGB, CMYK, or HSB, represents a different method for describing and classifying color. Color models use numeric values to represent the visible spectrum of color. A *color space* is a variant of a color model and has a specific *gamut* (range) of colors. For example, within the RGB color model are a number of color spaces: Adobe® RGB, sRGB, and Apple® RGB. While each of these color spaces defines color using the same three axes (R, G, and B), their gamuts are different.

About colors in digital graphics

We use color models to describe the colors we see and work with in digital graphics. Each color model, such as RGB, CMYK, or HSB, represents a different method for describing and classifying color. Color models use numeric values to represent the visible spectrum of color. A *color space* is a variant of a color model and has a specific *gamut* (range) of colors. For example, within the RGB color model are a number of color spaces: Adobe® RGB, sRGB, and Apple® RGB. While each of these color spaces defines color using the same three axes (R, G, and B), their gamuts are different.

When you work with the colors in a graphic, you are actually adjusting numerical values in the file. It's easy to think of a number as a color, but these numerical values are not absolute colors in themselves—they only have a color meaning within the color space of the device that is producing the color.

Because each device has its own color space, it can reproduce colors only in its gamut. When an image moves from one device to another, image colors may change because each device interprets the RGB or CMYK values according to its own color space. For example, it is impossible for all the colors viewed on a monitor to be identically matched in a print from a desktop printer. A printer operates in a CMYK color space, and a monitor operates in an RGB color space. Their gamuts are different. Some colors produced by inks cannot be displayed on a monitor, and some colors that can be displayed on a monitor cannot be reproduced using inks on paper.

Even though it is impossible to perfectly match all colors on different devices, you can use color management to ensure that most colors are the same or similar enough so they appear consistent.

RGB

A large percentage of the visible spectrum can be represented by mixing red, green, and blue (RGB) colored light in various proportions and intensities. Where the colors overlap, they create cyan, magenta, and yellow.

RGB colors are called *additive colors* because you create white by adding R, G, and B together—that is, all light is reflected back to the eye. Additive colors are used for lighting, television, and computer monitors. Your monitor, for example, creates color by emitting light through red, green, and blue phosphors.

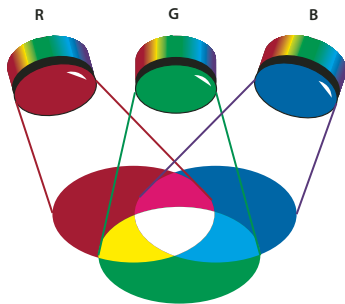

Additive colors (RGB)
R. Red G. Green B. Blue

You can work with color values using the RGB color mode, which is based on the RGB color model. In RGB mode, each of the RGB components can use a value ranging from 0 (black) to 255 (white). For example, a bright red color might have an R value of 246, a G value of 20, and a B value of 50. When the values of all three components are equal, the result is a shade of gray. When the value of all components is 255, the result is pure white; when all components have values of 0, the result is pure black.

Illustrator also includes a modified RGB color mode called *Web Safe RGB*, which includes only those RGB colors that are appropriate for use on the web.

More Help topics

[“Change the color mode of a document”](#) on page 146

CMYK

Whereas the RGB model depends on a light source to create color, the CMYK model is based on the light-absorbing quality of ink printed on paper. As white light strikes translucent inks, a portion of the spectrum is absorbed. Color that is not absorbed is reflected back to your eye.

Combining pure cyan (C), magenta (M), and yellow (Y) pigments would result in black by absorbing, or subtracting, all colors. For this reason they are called *subtractive colors*. Black (K) ink is added for better shadow density. (The letter *K* came into use because black is the “key” color for registering other colors, and because the letter B also stands for blue.) Combining these inks to reproduce color is called *four-color process printing*.

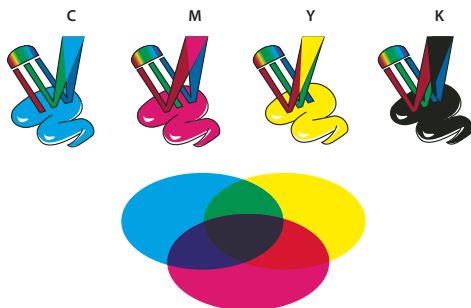

Subtractive colors (CMYK)
C. Cyan M. Magenta Y. Yellow K. Black

You can work with color values using the CMYK color mode, which is based on the CMYK color model. In CMYK mode, each of the CMYK process inks can use a value ranging from 0 to 100%. The lightest colors are assigned small percentages of process ink colors; darker colors have higher percentage values. For example, a bright red might contain 2% cyan, 93% magenta, 90% yellow, and 0% black. In CMYK objects, low ink percentages are closer to white, and high ink percentages are closer to black.

Use CMYK when preparing a document to be printed using process inks.

More Help topics

[“Change the color mode of a document”](#) on page 146

HSB

Based on the human perception of color, the HSB model describes three fundamental characteristics of color:

Hue Color reflected from or transmitted through an object. It is measured as a location on the standard color wheel, expressed as a degree between 0° and 360°. In common use, hue is identified by the name of the color, such as red, orange, or green.

Saturation Strength or purity of the color (sometimes called *chroma*). Saturation represents the amount of gray in proportion to the hue, measured as a percentage from 0% (gray) to 100% (fully saturated). On the standard color wheel, saturation increases from the center to the edge.

Brightness Relative lightness or darkness of the color, usually measured as a percentage from 0% (black) to 100% (white).

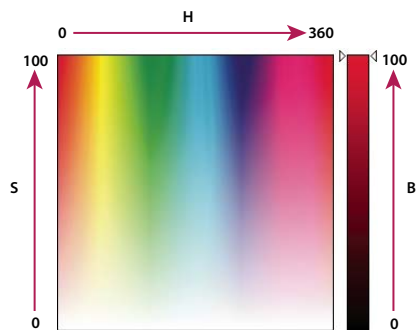

HSB color model
H. Hue S. Saturation B. Brightness

More Help topics

[“Adjust the saturation of multiple colors”](#) on page 147

Lab

The CIE Lab color model is based on the human perception of color. It is one of several color models produced by the Commission Internationale d’Eclairage (CIE), an organization dedicated to creating standards for all aspects of light.

The numeric values in Lab describe all the colors that a person with normal vision sees. Because Lab describes how a color looks rather than how much of a particular colorant is needed for a device (such as a monitor, desktop printer, or digital camera) to produce colors, Lab is considered to be a *device-independent* color model. Color management systems use Lab as a color reference to predictably transform a color from one color space to another color space.

In Illustrator, you can use the Lab model to create, display, and output spot color swatches. However, you cannot create documents in Lab mode.

More Help topics

[“Display and output spot colors using Lab values”](#) on page 146

Grayscale

Grayscale uses tints of black to represent an object. Every grayscale object has a brightness value ranging from 0% (white) to 100% (black). Images produced using black-and-white or grayscale scanners are typically displayed in grayscale.

Grayscale also lets you convert color artwork to high-quality black-and-white artwork. In this case, Adobe Illustrator discards all color information in the original artwork; the gray levels (shades) of the converted objects represent the luminosity of the original objects.

When you convert grayscale objects to RGB, the color values for each object are assigned that object’s previous gray value. You can also convert a grayscale object to a CMYK object.

More Help topics

[“Convert colors to grayscale”](#) on page 147

[“Convert grayscale images to RGB or CMYK”](#) on page 147

Color spaces and gamuts

A *color space* is a range of colors in the visible spectrum. A color space can also be a variant of a *color model*. Adobe RGB, Apple RGB, and sRGB are examples of different color spaces based on the same color model.

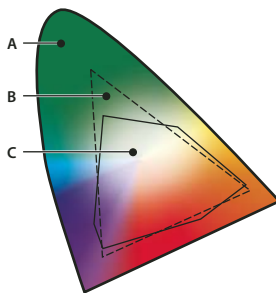

Gamuts of different color spaces
A. Visual gamut B. RGB color space C. CMYK color space

The range of color encompassed by a color space is called a gamut. The different devices (computer monitor, scanner, desktop printer, printing press, digital camera) throughout your workflow operate within different color spaces and each with different gamuts. Some colors within the gamut of your computer monitor are not within the gamut of your inkjet printer, and vice versa. When a color cannot be produced on a device, it’s considered to be outside the color space of that particular device. In other words, the color is *out of gamut*.

More Help topics

[“Shift an out-of-gamut color to a printable color”](#) on page 144

About spot and process colors

You can designate colors as either spot or process color types, which correspond to the two main ink types used in commercial printing. In the Swatches panel, you can identify the color type of a color using icons that appear next to the name of the color.

When applying color to paths and frames, keep in mind the final medium in which the artwork will be published, so that you apply color using the most appropriate color mode.

 *If your color workflow involves transferring documents among devices, you may want to use a color-management system (CMS) to help maintain and regulate colors throughout the process.*

About spot colors

A *spot color* is a special premixed ink that is used instead of, or in addition to, process inks, and that requires its own printing plate on a printing press. Use spot color when few colors are specified and color accuracy is critical. Spot color inks can accurately reproduce colors that are outside the gamut of process colors. However, the exact appearance of the printed spot color is determined by the combination of the ink as mixed by the commercial printer and the paper it's printed on, not by color values you specify or by color management. When you specify spot color values, you're describing the simulated appearance of the color for your monitor and composite printer only (subject to the gamut limitations of those devices).

Keep the following guidelines in mind when specifying a spot color:

- For best results in printed documents, specify a spot color from a color-matching system supported by your commercial printer. Several color-matching system libraries are included with the software.
- Minimize the number of spot colors you use. Each spot color you create will generate an additional spot color printing plate for a printing press, increasing your printing costs. If you think you might require more than four colors, consider printing your document using process colors.
- If an object contains spot colors and overlaps another object containing transparency, undesirable results may occur when exporting to EPS format, when converting spot colors to process colors using the Print dialog box, or when creating color separations in an application other than Illustrator or InDesign. For best results, use the Flattener Preview or the Separations Preview to soft proof the effects of flattening transparency before printing. In addition, you can convert the spot colors to process colors by using the Ink Manager in InDesign before printing or exporting.
- You can use a spot color printing plate to apply a varnish over areas of a process color job. In this case, your print job would use a total of five inks—four process inks and one spot varnish.

About process colors

A *process color* is printed using a combination of the four standard process inks: cyan, magenta, yellow, and black (CMYK). Use process colors when a job requires so many colors that using individual spot inks would be expensive or impractical, as when printing color photographs.

Keep the following guidelines in mind when specifying a process color:

- For best results in a high-quality printed document, specify process colors using CMYK values printed in process color reference charts, such as those available from a commercial printer.
- The final color values of a process color are its values in CMYK, so if you specify a process color using RGB (or LAB, in InDesign), those color values will be converted to CMYK when you print color separations. These conversions differ based on your color-management settings and document profile.

- Don't specify a process color based on how it looks on your monitor, unless you are sure you have set up a color-management system properly, and you understand its limitations for previewing color.
- Avoid using process colors in documents intended for online viewing only, because CMYK has a smaller color gamut than that of a typical monitor.
- Illustrator and InDesign let you specify a process color as either global or non-global. In Illustrator, global process colors remain linked to a swatch in the Swatches panel, so that if you modify the swatch of a global process color, all objects using that color are updated. Non-global process colors do not automatically update throughout the document when the color is edited. Process colors are non-global by default. In InDesign, when you apply a swatch to objects, the swatch is automatically applied as a global process color. Non-global swatches are unnamed colors, which you can edit in the Color panel.

Note: Global and non-global process colors only affect how a particular color is applied to objects, never how colors separate or behave when you move them between applications.

Using spot and process colors together

Sometimes it's practical to use process and spot inks in the same job. For example, you might use one spot ink to print the exact color of a company logo on the same pages of an annual report where photographs are reproduced using process color. You can also use a spot color printing plate to apply a varnish over areas of a process color job. In both cases, your print job would use a total of five inks—four process inks and one spot ink or varnish.

In InDesign, you can mix process and spot colors together to create mixed ink colors.

Comparing colors in InDesign and Illustrator

Adobe InDesign and Adobe Illustrator use slightly different methods for applying named colors. Illustrator lets you specify a named color as either global or nonglobal, and InDesign treats all unnamed colors as nonglobal, *process colors*.

The InDesign equivalents to global colors are *swatches*. Swatches make it easier to modify color schemes without having to locate and adjust each individual object. This is especially useful in standardized, production-driven documents like magazines. Because InDesign colors are linked to swatches in the Swatches panel, any change to a swatch affects all objects to which a color is applied.

The InDesign equivalents to nonglobal swatches are unnamed colors. Unnamed colors do not appear in the Swatches panel, and they do not automatically update throughout the document when the color is edited in the Color panel. You can, however, add an unnamed color to the Swatches panel later.

Named and unnamed colors only affect how a particular color updates in your document, never how colors separate or behave when you move them between applications.

Selecting colors

About selecting colors

You can select colors for your artwork from a variety of tools, panels, and dialog boxes in Illustrator. How you select color depends on the needs of your artwork. For example, if you want to use specific company-approved colors, you'll want to select colors from the company-approved swatch library. If you want to match your colors with colors in other artwork, you can use the eyedropper or the Color Picker and enter exact color values.

You can use any of the following features for selecting color:

Swatches panel and swatch library panels Provide individual colors and color groups. You can choose from preexisting swatches and libraries or create your own. You can also import libraries.

Color Picker Provides a color spectrum from which you can visually select colors, color value text boxes for manually defining colors, and color swatches.

Eyedropper tool Samples colors from your artwork when you click.

Color panel Provides a color spectrum, individual color value sliders (such as a Cyan slider), and color value text boxes. You can specify fill and stroke colors from the Color panel. From the Color panel menu, you can create inverse and complementary colors for the current fill or stroke color, and create a swatch from the selected color.

Color Guide panel Provides several harmony rules to choose from for creating color groups using a base color that you choose. You can create variations of colors using tints and shades, warm and cool colors, or vivid and muted colors. From this panel, you can open a color group in the Edit Colors/Recolor Artwork dialog box.

Edit Colors/Recolor Artwork dialog box Part of this dialog box provides tools for precisely defining or adjusting the colors in a color group or artwork. The other part lets you recolor your artwork using the colors from a color group, or reduce or convert your colors for output.

Add Selected Colors command or New Color Group button Create a color group containing the colors in selected artwork. This command and button are both located in the Swatches panel.

More Help topics

[“About swatches”](#) on page 122

[“Use swatch libraries”](#) on page 124

[“Color Picker overview”](#) on page 119

[“Color Guide panel overview”](#) on page 129

[“Edit Colors/Recolor Artwork dialog box overview”](#) on page 130

Color Picker overview

The Color Picker lets you select an object’s fill or stroke color by choosing from a color field and spectrum, defining colors numerically, or clicking a swatch.

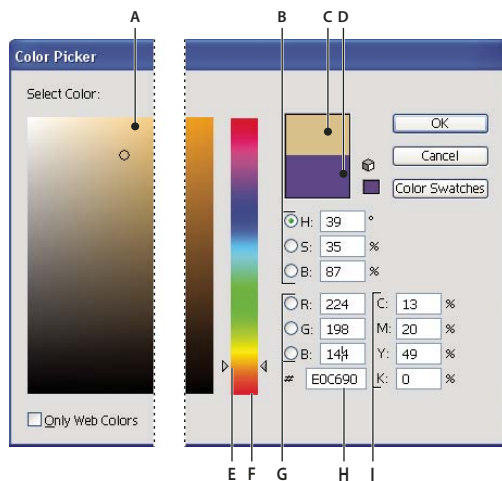

Color Picker

A. Color field B. HSB color values C. New color rectangle D. Original color rectangle E. Color slider F. Color spectrum G. RGB color values H. Hexadecimal color value I. CMYK color values

More Help topics

[“About colors in digital graphics”](#) on page 113

Display the Color Picker

- ❖ Double-click the fill or stroke color selection box in the Tools panel or Color panel.

Change the color spectrum displayed in the Color Picker

- ❖ Click a letter: H (Hue), S (Saturation), B (Brightness), R (Red), G (Green), or B (Blue).

Display only web-safe colors

Web-safe colors are those colors used by all web browsers, regardless of the platform.

- ❖ Select Only Web Colors.

View color swatches instead of the color spectrum

- ❖ Click Color Swatches. Click Color Models to return to view the color spectrum.

Select colors using the Color Picker

Do any of the following:

- 1 Click or drag inside the color spectrum. A circular marker indicates the color’s position in the spectrum.
- 2 Drag the triangles along the color slider or click inside the color slider.
- 3 Enter values in any of the text boxes.
- 4 Click Color Swatches, select a swatch, and click OK.

Color panel overview

You use the Color panel (Window > Color) to apply color to an object's fill and stroke, and also to edit and mix colors. The Color panel can display color values using different color models. By default, only the most commonly used options are visible in the Color panel.

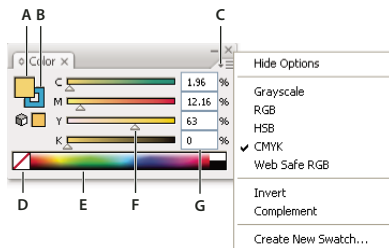

Color panel

A. Fill color B. Stroke color C. panel menu D. None box E. Color spectrum bar F. Color slider G. Text box for a color component

More Help topics

[“About colors in digital graphics”](#) on page 113

[“Manage windows and panels”](#) on page 9

Change the color model

- ❖ Select Grayscale, RGB, HSB, CMYK, or Web Safe RGB from the panel menu.

Show all options in the panel

- ❖ Select Show Options from the panel menu. Alternatively, click the double triangle on the panel's tab to cycle through the display sizes.

Select colors using the Color panel

- 1 Select the color mode you want to use from the panel menu. The mode you select affects only the display of the Color panel; it does not change the color mode of the document.
- 2 Do one of the following:
 - Drag or click in a slider.
 - Shift-drag a color slider to move the other sliders in relation to it (except for HSB sliders). This keeps a similar color but with a different tint or intensity.
 - Enter values in any of the text boxes.
 - Click in the color spectrum bar at the bottom of the panel. To select no color, click the None box at the left of the color bar; to select white, click the white swatch at the upper-right corner of the color bar; to select black, click the black swatch at the lower-right corner of the color bar.

Using and creating swatches

About swatches

Swatches are named colors, tints, gradients, and patterns. The swatches associated with a document appear in the Swatches panel. Swatches can appear individually or in groups.

You can open libraries of swatches from other Illustrator documents and various color systems. Swatch libraries appear in separate panels and are not saved with the document.

The Swatches panel and swatch library panels can contain the following types of swatches:

Process colors A process color is printed using a combination of the four standard process inks: cyan, magenta, yellow, and black. By default, Illustrator defines new swatches as process colors.

Global process colors A global color is automatically updated throughout your artwork when you edit it. All spot colors are global; however, process colors can be either global or local. You can identify global color swatches by the global color icon  (when the panel is in list view) or a triangle in the lower corner (when the panel is in thumbnail view).

Spot colors A spot color is a premixed ink that is used instead of, or in addition to, CMYK process inks. You can identify spot-color swatches by the spot-color icon  (when the panel is in list view) or a dot in the lower corner (when the panel is in thumbnail view).



Gradients A gradient is a graduated blend between two or more colors or tints of the same color or different colors. Gradient colors can be assigned as CMYK process colors, RGB colors, or a spot color. Transparency applied to a gradient stop, is preserved when the gradient is saved as a gradient swatch. The aspect-ratio and angle values of elliptical gradients (those created by adjusting the aspect ratio or angle of a radial gradient) are not saved.

Patterns Patterns are repeating (tiled) paths, compound paths, text with solid fills or no fill.

None The None swatch removes the stroke or fill from an object. You can't edit or remove this swatch.

Registration The registration swatch  is a built-in swatch that causes objects filled or stroked with it to print on every separation from a PostScript printer. For example, registration marks use the Registration color so that printing plates can be aligned precisely on a press. You can't remove this swatch.

Note: If you use the Registration color for type, and then you separate the file and print it, the type may not register properly and the black ink may appear muddy. To avoid this, use black ink for type.

Color groups Color groups can contain process, spot, and global process colors. They cannot contain pattern, gradient, none, or registration swatches. You create color groups based on harmonies by using either the Color Guide panel or the Edit Colors/Recolor Artwork dialog box. To put existing swatches into a color group, select the swatches and click the New Color Group icon  in the Swatches panel. You can identify a color group by the folder icon .

You can also create tints in the Swatches panel. A tint is a global process color or spot color with a modified intensity. Tints of the same color are linked together, so that if you edit the color of a tint swatch, all associated tint swatches (and the objects painted with those swatches) change color, though the tint values remain unchanged. Tints are identified by a percentage (when the Swatches panel is in list view)

Swatches panel overview

You use the Swatches panel (Window > Swatches) to control all document colors, gradients, and patterns. You can name and store any of these items for instant access. When a selected object's fill or stroke contains a color, gradient, pattern, or tint applied from the Swatches panel, the applied swatch is highlighted in the Swatches panel.

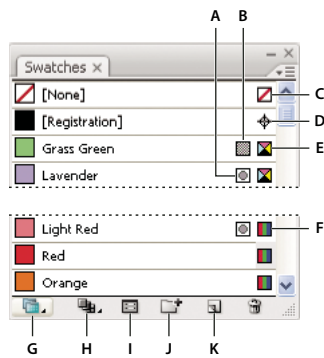
Color

Swatches panel in Small List view

A. Spot color B. Global color C. Fill or stroke of None D. Registration swatch (prints on all plates) E. CMYK symbol (when document is open in CMYK mode) F. RGB symbol (when document is open in RGB mode) G. Swatch Library Menu button H. Show Swatch Kinds Menu button I. Swatch Options button J. New Color Group button K. New Swatch button

More Help topics

“[Manage windows and panels](#)” on page 9

Change the display of swatches

- ❖ Select a view option from the Swatches panel menu: Small Thumbnail View, Medium Thumbnail View, Large Thumbnail View, Small List View, or Large List View.

Show a specific type of swatch and hide all others

- ❖ Click the Show Swatch Kinds button , and choose one of the following: Show All Swatches, Show Color Swatches, Show Gradient Swatches, Show Pattern Swatches, or Show Color Groups.



Select all swatches that aren't used in artwork

If you want to limit your Swatches panel to only the colors that are used in a document, you can select all unused swatches and then delete them.

- ❖ Choose Select All Unused in the Swatches panel menu.

Select a color group

- To select the entire group, click the color group icon .
- To select swatches inside the group, click individual swatches.

Note: To edit the selected color group, make sure no artwork is selected and click the Edit Color Group button , or double-click the color group folder. To edit the selected color group and apply the edits to selected artwork, click the Edit Or Apply Colors button , or double-click the color group folder. For more information, see “[Edit colors in the Edit Colors dialog box](#)” on page 134.

Select a swatch by name

- ❖ Select Show Find Field from the Swatches panel menu. Type the first letter or letters of the swatch's name in the Find text box at the top of the panel.

Note: This procedure does not work with double-byte characters.

You can also use this method to select a PANTONE® swatch by entering the PANTONE number.

Move swatches into a color group

- 1 Drag individual color swatches to an existing color group folder.
- 2 Select the colors you want in a new color group and click the New Color Group button .

Change the order of swatches

You can reorder individual swatches as well as swatches inside a color group.

- ❖ Do one of the following:
 - Select Sort By Name or Sort By Kind from the Swatches panel menu. These commands only work on individual swatches, not swatches in a color group.
 - Drag a swatch to a new location.

Use swatch libraries

Swatch libraries are collections of preset colors, including ink libraries such as PANTONE, HKS, Trumatch, FOCOLTONE, DIC, TOYO, and thematic libraries such as camouflage, nature, Greek, and jewel tones.

When you open a swatch library, it appears in a new panel (not the Swatches panel). You select, sort, and view swatches in a swatch library the same as you do in the Swatches panel. However, you can't add swatches to, delete swatches from, or edit the swatches in the Swatch libraries panel.

 *To make a swatch library appear each time Illustrator is started, select Persistent from the swatch library's panel menu.*

More Help topics

[“Share swatches between applications”](#) on page 125

Open a swatch library



- ❖ Do one of the following:
 - Choose Window > Swatch Libraries > *[library name]*.
 - In the Swatches panel menu, choose Open Swatch Library > *[library name]*.
 - In the Swatches panel, click the Swatch Libraries Menu button , and choose a library from the list.

Note: PANTONE color libraries are located in the Color Books subfolder (Swatch Libraries > Color Books > PANTONE...).

Create a swatch library

You create a swatch library by saving the current document as a swatch library.

- 1 Edit the swatches in the Swatches panel so that it contains only the swatches you want in the swatch library.
- 2 Select Save Swatch Library from the Swatches panel menu.

 *To remove all swatches that aren't used in the document, choose Select All Unused from the Swatches panel menu, and then click the Delete Swatch button .*

Edit a swatch library

- 1 Choose File > Open, locate and open the library file. By default, swatch library files are stored in the Illustrator/Presets/Swatches folder.
- 2 Edit the colors in the Swatches panel and save your changes.

Move swatches from a swatch library to the Swatches panel

Do any of the following:

- Drag one or more swatches from the swatch library panel to the Swatches panel.
- Select the swatches you want to add, and select Add To Swatches from the library's panel menu.
- Apply a swatch to an object in the document. If the swatch is a global or spot-color swatch, the swatch is automatically added to the Swatches panel.

Add colors from artwork to Swatches panel

You can automatically add all the colors from selected artwork or all the colors in your document to the Swatches panel. Illustrator finds the colors that are not already in the Swatches panel, converts any process colors to global colors, and adds them to the panel as new swatches.

When you automatically add colors to the Swatches panel, all colors in the document are included, except the following:

- Colors inside opacity masks (when not in opacity mask editing mode)
- Interpolated colors in blends
- Colors in image pixels
- Guide colors
- Colors in objects that are inside compound shapes and are not visible

If you change a gradient fill, pattern fill, or symbol instance to a new global color, the color is added as a new swatch and the original color swatch is retained.

Add all document colors

- ❖ Make sure that nothing is selected, and choose Add Used Colors from the Swatches panel menu.

Add colors from selected artwork

- ❖ Select the objects containing the colors you want to add to the Swatches panel, and do one of the following:
 - Choose Add Selected Colors from the Swatches panel menu.
 - Click the New Color Group button  in the Swatches panel. Specify options in the dialog box that appears. Colors are arranged and saved using the Hue Forward rule.

Share swatches between applications

You can share the solid swatches you create in Photoshop, Illustrator, and InDesign by saving a swatch library for exchange. The colors appear the same across applications as long as your color settings are synchronized.

Note: You can create and share color group swatches by using the Kuler panel or the Kuler website. (See “Kuler panel” on page 143.)

- 1 In the Swatches panel, create the process and spot-color swatches you want to share, and remove any swatches you don’t want to share.

Note: You cannot share the following types of swatches between applications: patterns, gradients, and the Registration swatch from Illustrator or InDesign; and book color references, HSB, XYZ, duotone, monitorRGB, opacity, total ink, and webRGB swatches from Photoshop. These types of swatches are automatically excluded when you save swatches for exchange.

- 2 Select Save Swatches For Exchange from the Swatches panel menu, and save the swatch libraries in an easily accessible location.
- 3 Load the swatch library into the Swatches panel for Photoshop, Illustrator, or InDesign.

Import swatches from another document

You can import all swatches or individual swatches from another document.

- To import all swatches from another document, choose Window > Swatch Libraries > Other Library or choose Open Swatch Library > Other Library from the Swatches panel menu. Select the file from which you want to import swatches, and click Open. The imported swatches appear in a swatch library panel (not the Swatches panel).
- To import individual swatches from another document, copy and paste objects that use the swatches. The imported swatches appear in the Swatches panel.

Note: If imported swatches for spot colors or global process colors have the same name but different color values as swatches already in the document, a swatch conflict occurs. For spot color conflicts, the color values of the existing swatches are preserved and imported swatches are automatically merged with the existing swatches. For process color conflicts, the Swatch Conflict dialog box appears, and color values for existing swatches are automatically retained. You can choose “Add Swatches” to add the swatches by appending a number to the conflicting swatch names or choose “Merge Swatches” to merge the swatches using the color values of the existing swatches.

More Help topics

[“Swatches panel overview”](#) on page 122

[“Use swatch libraries”](#) on page 124

Create color swatches

You can create process color, spot color, or gradient color swatches.

More Help topics

[“About swatches”](#) on page 122

[“About process colors”](#) on page 117

[“About spot colors”](#) on page 117

[“Gradients”](#) on page 188

Create a process color swatch

- 1 Select a color using the Color Picker or Color panel, or select an object with the color you want.

2 Do one of the following:

- Drag the color from the Tools panel or Color panel to the Swatches panel.
- In the Swatches panel, click the New Swatch button or select New Swatch from the panel menu. In the dialog box that appears, select Global if you want the swatch to be a global color. Set additional swatch options, and click OK. (See “[Swatch options](#)” on page 128.)

Create gradient swatches

1 Create a gradient using the Gradient panel, or select an object with the gradient you want.

2 Do one of the following:

- Drag the gradient fill from the Fill box in the Tools panel or Color panel to the Swatches panel.
- In the Gradient panel, click the gradient menu (next to the gradient box) and click the Save To Swatches Library icon .
- In the Swatches panel, click the New Swatch button or select New Swatch from the Swatches panel menu. In the dialog box that appears, enter a swatch name, and click OK. (See “[Swatch options](#)” on page 128.)

Create spot-color swatches

1 Select a color using the Color Picker or Color panel, or select an object with the color you want.

2 Do one of the following:

- Ctrl-drag (Windows) or Command-drag (Mac OS) the color from the Tools panel or Color panel to the Swatches panel.
- In the Swatches panel, Ctrl-click (Windows) or Command-click (Mac OS) the New Swatch button, or select New Swatch from the panel menu. In the dialog box that appears, select Spot Color for Color Type. Set additional swatch options and click OK. (See “[Swatch options](#)” on page 128.)

Create a swatch from the Color Guide panel

1 Choose colors from the Harmony Rules menu in the Color Guide panel.

2 Click the Save Color Group To Swatch Panel button  at the bottom of the Color Guide panel.

Manage swatches

You can manage the swatches in your Swatches panel by duplicating, grouping, replacing, merging, or deleting them. You can also specify swatch options such as swatch name, color type, color mode, or preview.

More Help topics

“[Swatches panel overview](#)” on page 122

“[Create a color group in the Edit Colors dialog box](#)” on page 133

Duplicate swatches

1 Select one or more swatches that you want to duplicate.

2 Do one of the following:

- Select Duplicate Swatch from the Swatches panel menu.
- Drag the swatches to the New Swatch button in the Swatches panel.

Group swatches

When you want to keep specific colors together in the Swatches panel, create a color group. For example, you can create a color group for colors you select in the Color Guide panel. When you save a color group in the Edit Colors dialog box, it is automatically saved as a color group in the Swatches panel. You can also manually group any set of solid color swatches.

- 1 Select one or more swatches in the Swatches panel.
- 2 Click the New Color Group button, or choose New Color Group from the panel menu.

Replace, merge, or delete swatches

- To replace a swatch, hold down Alt (Windows) or Option (Mac OS) and drag the color or gradient from the Color panel, Gradient panel, an object, or the Tools panel to the Swatches panel, highlighting the swatch you want to replace.

Replacing an existing color, gradient, or pattern in the Swatches panel globally changes objects in the file containing that swatch color with the new color, gradient, or pattern. The only exception is for a process color that does not have the Global option selected in the Swatch Options dialog box.

- To merge multiple swatches, select two or more swatches, and select Merge Swatches from the Swatches panel menu. The first selected swatch name and color value replaces all other selected swatches.
- To delete a swatch, select one or more swatches. Select Delete Swatch from the panel menu, click the Delete Swatch button, or drag the selected swatches to the Delete Swatch button.

When you delete a spot-color or global process-color swatch (or a pattern or gradient containing a spot or global process color), all objects painted with those colors are converted to the non-global process color equivalent.

Swatch options



To set swatch options, double-click an existing swatch or select New Swatch from the Swatches panel menu.

Swatch Name Specifies the name of the swatch in the Swatches panel.

Color Type Specifies if the swatch is a process color or spot color.

Global Creates a global process-color swatch.

Color Mode Specifies the color mode of the swatch.

After you select the color mode you want, you can use the color sliders to adjust the color. If you select a color that is not web-safe, an alert cube  appears. Click the cube to shift to the closest web-safe color (which is displayed to the right of the cube). If you select an out-of-gamut color, an alert triangle  appears. Click the triangle to shift to the closest CMYK equivalent (which is displayed to the right of the triangle).

Preview Displays color adjustments on any objects to which the swatch is applied.

Working with color groups (harmonies)

About color groups

A color group is an organization tool that lets you group together related color swatches in the Swatches panel. In addition, a color group can be a container for color harmonies, which you create using the Edit Colors/Recolor Artwork dialog box or the Color Guide panel. Color groups can contain only solid colors that include spot, process, or global colors. Gradients and patterns cannot be grouped.

Color

You can use the Color Guide panel or the Edit Colors/Recolor Artwork dialog box to create harmonious color groups. Using either feature, you can choose a harmony rule to instantly generate a color scheme based on any color you want. For example, choose the Monochromatic harmony rule to create a color group containing all the same hue, but with different saturation levels. Or choose the High Contrast or Pentagram harmony rule to create a color group with contrasting colors for more visual impact.

For inspiration, to share color harmonies, or to create color groups outside Illustrator, choose Window > Extensions > Kuler and click through the different color harmonies available.

For more information, see the Kuler website at <http://kuler.adobe.com/>.

More Help topics

“Group swatches” on page 128

“Kuler panel” on page 143

Color Guide panel overview



Use the Color Guide panel as a tool for color inspiration while you create your artwork. The Color Guide panel suggests harmonious colors based on the current color in the Tools panel. You can use these colors to color artwork, or you can edit them in the Edit Colors/Recolor Artwork dialog box, or save them as swatches or swatch groups in the Swatches panel.

You can manipulate the colors that the Color Guide panel generates in several ways, including changing the harmony rule, or adjusting the variation type (such as tints and shades or vivid and muted), and the number of variation colors that appear.

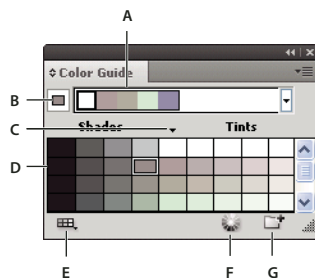
Important: If you have artwork selected, clicking a color variation changes the color of the selected artwork, just like clicking a swatch in the Swatches panel.



A. Harmony Rules menu and active color group B. Set as base color C. Active colors D. Color variations E. Limits colors to specified swatch library F. Edit Colors or Edit Or Apply Colors depending on selection (opens the colors in the Edit Colors/Recolor Artwork dialog box) G. Save group to Swatches panel

Note: To edit the selected color group, make sure that no artwork is selected and click the Edit Colors button . To edit the selected color group and apply the edits to selected artwork, click the Edit Or Apply Colors button . For more information, see “Edit colors in the Edit Colors dialog box” on page 134.

For a video on using the Color Guide to find and create color solutions, see www.adobe.com/go/vid0058.

Specify the type of color variations that appear in the panel

❖ Choose one of the following variations from the Color Guide panel menu:

Show Tints/Shades Adds black to variations on the left and white to variations on the right

Show Warm/Cool Adds red to variations on the left and blue to variations on the right

Show Vivid/Muted Decreases the saturation toward gray in variations on the left and increases saturation toward gray in variations on the right

Note: If you're using spot colors, use only the Tints/Shades variation and choose colors from the tint (right) side of the variation grid. All other variations cause spot colors to be converted to process.

Specify the number and range of color variations that appear in the panel

- 1 Choose Color Guide Options from the Color Guide panel menu.
- 2 Specify the number of colors you want to appear to the left and right of each color in the generated color group. For example, choose 6 if you want to see six shades darker and six shades lighter of each color.

The original colors always appear down the center of the panel with a triangle directly above them, and the variations on those colors appear to the left and right of them.

- 3 Drag the Range slider to the left to decrease the variance range or drag to the right to increase the range.

Decreasing the range generates colors that are more similar to the originals.

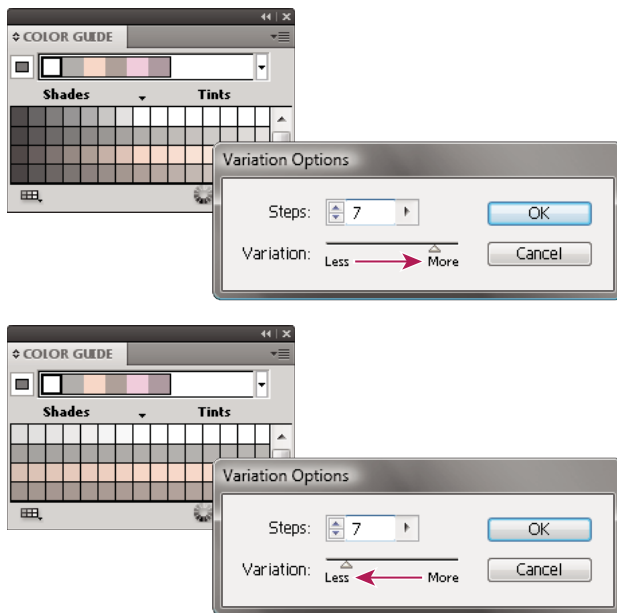

Adjusting the range of color variations

Edit Colors/Recolor Artwork dialog box overview

The name of this dialog box changes depending on context:

When you have artwork selected and you access the dialog box by clicking the  icon in the Control panel, Swatches panel, or Color Guide panel, or when you choose Edit > Edit Colors > Recolor Artwork, the dialog box opens as the Recolor Artwork dialog box and you have access to the Assign tab and the Edit tab.

When you do not have artwork selected and you access the dialog box by clicking the  icon in the Control panel, Swatches panel, or Color Guide panel, the dialog box opens as the Edit Colors dialog box and you have access to the Edit tab only.

Regardless of which name appears at the top of the dialog box, the right side of it always displays the color groups for the current document, along with two default color groups: Print Color and Grayscale. You can select and use these color groups at anytime.

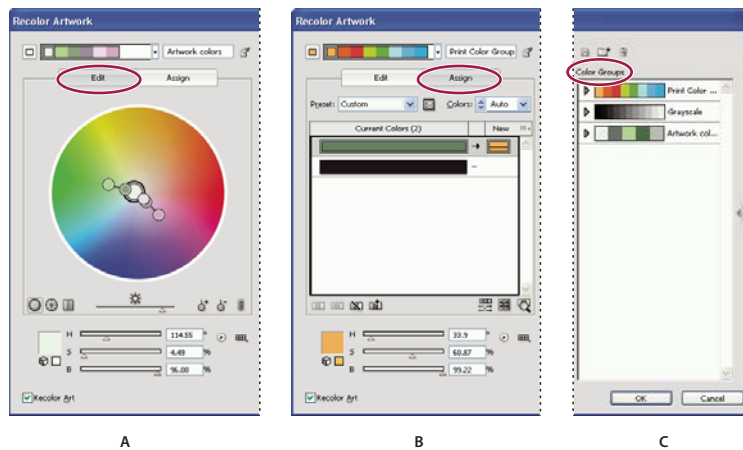

A. Create and edit color groups in the Edit tab B. Assign colors in the Assign tab C. Select a color group from the Color Groups list

The Recolor Art option at the bottom of the dialog box lets you preview colors on selected artwork, and specifies whether artwork is recolored when you close the dialog box.

The main areas of the dialog box are:

Edit Use the Edit tab to create new color groups or edit existing color groups. Use the Harmony Rules menu and the color wheel to experiment with color harmonies. The color wheel shows you how colors in a harmony are related, while the color bars let you see and manipulate individual color values. In addition, you can adjust brightness, add and remove colors, save color groups, and preview the colors on selected artwork.

Assign Use the Assign tab to view and control how colors from a color group replace original colors in your artwork. You can assign colors only if you have artwork selected in the document. You can specify which new colors replace which current colors, whether spots are preserved, and how colors are replaced (for example, you can replace colors entirely or replace hue while retaining brightness). Use Assign to control how artwork is recolored with the current color group or to reduce the number of colors in the current artwork.

Color Groups Lists all saved color groups for the open document (these same color groups appear in the Swatches panel). While in the dialog box, you can edit, delete, and create new color groups using the Color Groups list. All your changes are reflected in the Swatches panel. The selected color group denotes which color group is currently being edited. You can select any color group and edit it or use it to recolor selected artwork. Saving a color group adds the group to this list.

For a video on creating, editing, and experimenting with color groups in the Edit Colors/Recolor Artwork dialog box, see www.adobe.com/go/lrvid4019_ai. For a video on integrating color harmonies with smart objects in Photoshop and InDesign, see www.adobe.com/go/vid0191. To see an example of changing a vibrant color illustration to a grayscale illustration, see www.adobe.com/go/learn_ai_tutorials_depth_en.

More Help topics

“Create a color group in the Edit Colors dialog box” on page 133

“Edit colors in the Edit Colors dialog box” on page 134

“Assign colors to your artwork” on page 139

“Reduce colors in your artwork” on page 142

Open the Edit Colors/Recolor Artwork dialog box

- ❖ Open the Edit Colors/Recolor Artwork dialog box from any of the following locations:

Edit > Edit Colors > Recolor Artwork or Recolor With Presets command Use these commands when you want to edit colors in selected artwork.





Recolor Artwork button  **in Control panel** Use this button when you want to edit the colors of the selected artwork using the Recolor Artwork dialog box. This button is available when the selected artwork contains two or more colors.

Note: Editing colors this way is a convenient way to globally adjust colors in artwork when global colors weren't used in the artwork's creation.

Edit Colors or Edit Or Apply Colors button  **in Color Guide panel** Click this button when you want to edit the colors in the Color Guide panel, or edit and then apply the colors in the Color Guide panel to selected art.

Edit Color Group or Edit Or Apply Color Group button  **in Swatches panel** Click this button when you want to edit the colors in the selected color group, or when you want to edit the colors and apply them to the selected artwork. You can also double-click a color group in the Swatches panel to open the dialog box.

Work with the Color Group list

- To show or hide the Color Group list, click the Hide Color Group Storage icon  on the right side of the Edit Colors/Recolor Artwork dialog box. To display the list again, click the icon again.
- To add a new color group to this list, create or edit a color group, and then click New Color Group . A new color group appears in the list.
- To edit a color group, click it in the list to select it. Change the color group using the Edit tab, and then click Save Changes To Color Group .
- To delete a color group, select it and click Delete Color Group .

Create color groups

You can create color groups using the Color Guide panel or the Edit Colors/Recolor Artwork dialog box. You can also create and share color groups on the Adobe Kuler website (www.Kuler.adobe.com).

For a video on using the Color Guide to find and create color solutions, see www.adobe.com/go/vid0058. For a video on creating, editing, and experimenting with color groups in Live Color, see www.adobe.com/go/lrvid4019_ai.

More Help topics

[“Swatches panel overview”](#) on page 122



[“Edit colors in the Edit Colors dialog box”](#) on page 134

[“Create a color group in the Edit Colors dialog box”](#) on page 133

Create a color group in the Color Guide panel

Make sure that no artwork is selected when you set the base color; otherwise, the selected artwork will change to the base color.



- 1 Open the Color Guide panel, and do any of the following to set the base color for the color harmony:
 - Click a color swatch in the Swatches panel.
 - Click a color in the Color panel. (You may want to drag out the Color panel so that you can use it along with the Color Guide panel.)

- Double-click the Fill Color in the Tools panel and pick a color in the Color Picker.
- Using the eyedropper, click artwork containing the color you want.
- Select artwork containing the color you want, and then click the Set Base Color To The Current Color icon .
- Click a color variation in the Color Guide panel, and then click the Set Base Color To The Current Color icon .

2 Choose a rule from the Harmony Rules menu.

Note: To confine colors to a swatch library, click the Limits The Color Group To Colors In A Swatch Library button , and choose library from the list.

3 To save the color group or an individual color to the Swatches panel, do one of the following:

- To save the current color group in the Color Guide panel, click the Save Color Group To Swatches Panel button .
- To save one or more color variations as individual swatches, drag the colors from the Color Guide panel to the Swatches panel.
- To save multiple color variations as a group, select them in the Color Guide panel and click the Save Color Group To Swatches Panel button .

To name the new group, select the group in the Swatches panel and choose Color Group Options from the panel menu.

Note: To upload your color group swatch to the Kuler website, select it and choose Window > Extensions > Kuler. In the Kuler dialog box, click Upload . You must register with Kuler before you can upload swatches.

4 To color your artwork with a color from the color group, select your artwork and click any color in the Color Guide panel.

Note: To color all objects in a grouped object, select it, choose Edit > Recolor Artwork, and specify options in the Recolor Artwork dialog box. (See “Assign colors to your artwork” on page 139.)

Create a color group in the Edit Colors dialog box

You create a color group in the Edit Colors/Recolor Artwork dialog box by choosing a base color and a harmony rule. The harmony rule uses the base color as the basis for generating the colors in the color group. For example, if you choose a blue base color and the Complementary harmony rule, a color group is created using the base color, blue, and its complement, red.

As you manipulate the colors in the color wheel, the selected harmony rule continues to govern the colors that are generated for the group. To break the harmony rule and edit the colors freely, click the Unlink button .

1 Open the Edit Colors/Recolor Artwork dialog box, and choose a color harmony from the Harmony Rules menu, if desired.

Note: To confine colors to a swatch library, click the Limits The Color Group To Colors In A Swatch Library button , and choose a library from the list.

2 If the color bars are showing, click a Color Wheel icon to display the color wheel instead.

3 Set the base color by doing one of the following:

- Drag the base color marker (the largest, double-ringed color marker) around the wheel to set the base color you want.
- Adjust the color sliders at the bottom of the dialog box.

4 Choose a new harmony rule or move the color markers, as desired.

5 To preview the new colors on selected artwork, click Recolor Art.

Note: Recolor Art will recolor selected artwork when you click OK to close the dialog box. If you don't want to recolor the selected art, make sure to deselect this option before clicking OK.

- 6 Type a name in the Name box to the right of the Harmony Rules menu, and click New Color Group .

Note: if the New Color Group icon is not visible, click the Show Color Group Storage icon .

- 7 To save the new color group to the Swatches panel, click OK and close the Edit Colors/Recolor Artwork dialog box.

Note: You can also create a color group by using the Color Guide. (See “Create a color group in the Color Guide panel” on page 132.)

Edit colors in the Edit Colors dialog box

Editing colors in the Edit Colors/Recolor Artwork dialog box is a convenient way to globally adjust the colors in selected artwork. It is especially useful when global colors weren't originally used in the artwork's creation. You can edit colors and color groups in the Edit Colors/Recolor Artwork dialog box and apply your edits to selected artwork, or save the edited colors for later use.

When editing colors, you use the smooth color wheel, the segmented color wheel, or the color bars.

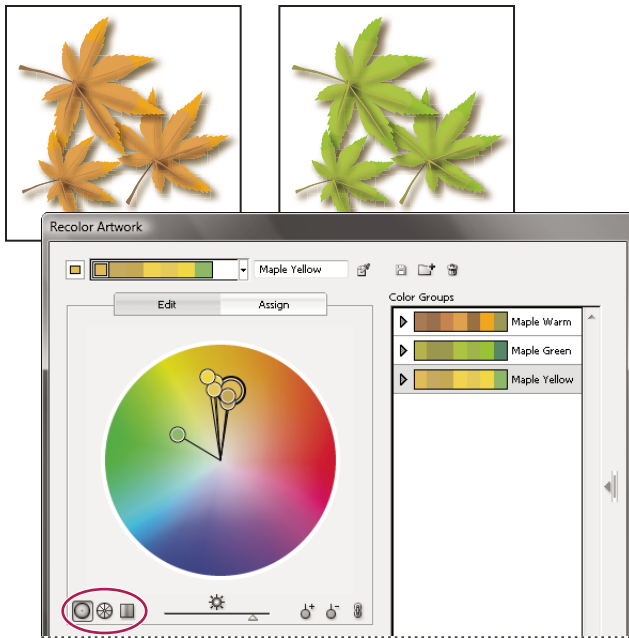

Editing colors by moving color markers on the smooth color wheel

Smooth color wheel  Displays hue, saturation, and brightness in a smooth continuous circle. Each color in the current color group is drawn on the wheel inside a circle. This wheel lets you choose from numerous colors with great precision, but it can be hard to see individual colors because every pixel is a different color.

Segmented color wheel  Displays colors as a set of segmented color patches. This wheel makes it easy to see individual colors, but doesn't provide as many colors to choose from as the continuous wheel.

Color bars  Displays only colors from the color group. They appear as solid bars of color that you can select and edit individually. You can reorganize colors in this display by dragging and dropping color bars to the left or right. You can right-click a color and choose to remove it, set it as the base color, change its shade, or change it using the Color Picker.

For a video on creating, editing, and experimenting with color groups, see www.adobe.com/go/lrvid4019_ai. To see an example of changing a vibrant color illustration to a grayscale illustration, see www.adobe.com/go/learn_ai_tutorials_depth_en.

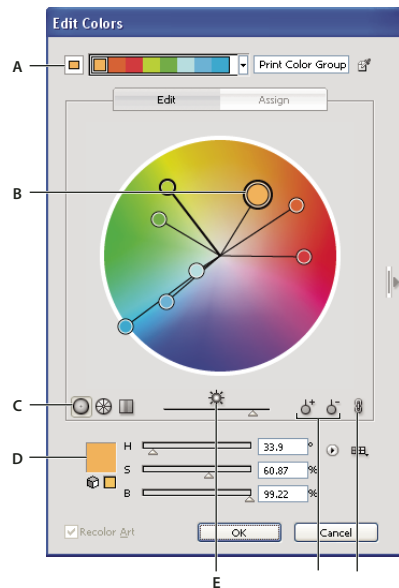



A. Base color as it appears in Harmony Rules menu B. Base color as it appears in color wheel C. Color display options D. Color of selected color marker or color bar E. Show saturation and hue on Wheel F. Add and subtract color marker tools G. Unlink harmony colors

Save changes to a color group

Before you start editing your color groups, make sure that you know how to save your changes correctly so you don't inadvertently overwrite your favorite color group! You have two options when saving your changes: you can overwrite the original color group with the edited color group, or you can create a new color group with the changes, leaving the original intact.



❖ Do either of the following:

- To keep your original color group unchanged and save the changes as a new color group, click New Color Group  at the top of the Edit Colors/Recolor Artwork dialog box.
- To save the changes to your original color group (thus overwriting the original color group), click Save Changes To Color Group .

Edit a color group using a color wheel

- 1 In the Edit Colors/Recolor Artwork dialog box, select the desired color group from the Color Groups storage area, if necessary.
- 2 If you have selected an object on the artboard, click Recolor Art to preview the colors on the artwork. If you don't want to recolor the artwork, deselect Recolor Art before closing the dialog box, or click Cancel to close it.



Note: To edit the colors of the selected artwork, click Get Colors From Selected Art .



- 3 To confine colors to a swatch library, click the Limits The Color Group To Colors In A Swatch Library button , and choose a library from the list.
- 4 To change the base color to a different color in the current group, right-click the color in a color wheel or color bars and choose Set As Base Color. Or click a color in the Active Colors box, and then click Set Current Color As Base Color  to the left of the Active Colors box.

Color

- 5 Drag a marker on the wheel to change its color. If the harmony is linked, all the colors move according to the rule as you drag. If the harmony is unlinked, only the marker that you drag moves.

While editing, you can do any of the following:

- a To change hue, move the marker around the wheel. To change saturation or brightness, move it inward and outward on the wheel.
 - b To add a color, right-click in the color wheel where you want to add the color and choose Add New Color.
 - c To remove a color, right-click on the color marker (or the line of the marker) in the color wheel and choose Remove Color.
 - d To change a color using the Color Picker, right-click the color and choose Color Picker.
 - e To constrain the marker to move in only one direction, hold down the shift key as you drag.
 - f To see hue and saturation instead of hue and brightness on the wheel, click the Show Saturation And Hue On The Wheel button , directly below the wheel to toggle between the two views.
 - g To change the color values manually, click the color marker or click the color in the Active Colors box. Edit the color values using the sliders or color value text boxes under the color wheel.
 - h To change the saturation and brightness of a color on the wheel, right-click a color marker, and choose Select Shade; then click the desired color in the box that appears.
- 6 Save your changes by clicking New Color Group , which keeps your original color group unchanged and saves the changes as a new color group. Or click Save Changes To Color Group  to overwrite your original color group with the changes.

Note: To ensure that the colors are in gamut or web safe, select each color marker and click the Out Of Gamut  or Out Of Web  buttons as necessary.

Reorder colors in a color group

- ❖ Do one of the following:
 - In the Active Colors menu, drag a color left or right.
 - In Color Bars view, drag a color bar left or right.

Edit an individual color in a color group

When you use a harmony rule to create a color group, the colors are linked by default. When a color group is linked, editing one color changes the other colors according to the harmony rule. To edit one color without changing the others, unlink the color markers from the harmony rule.

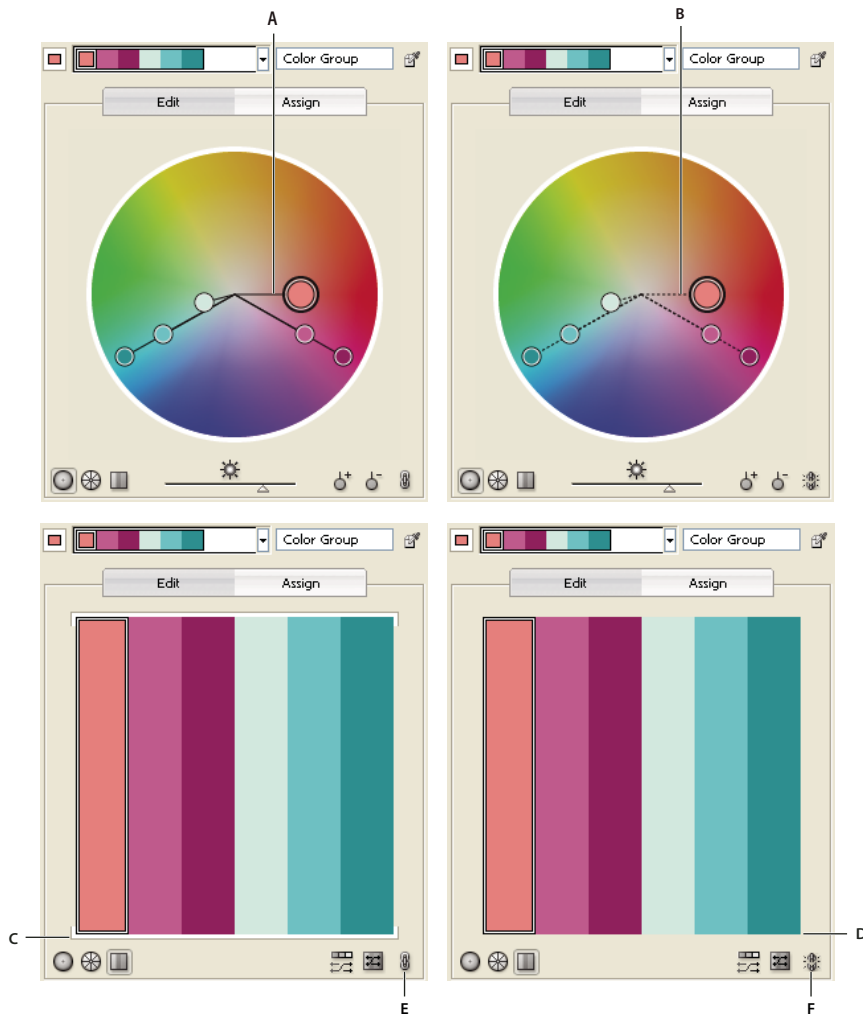



A. Color wheel view of linked colors B. Color wheel view of unlinked colors C. Color bars view of linked colors D. Color bars view of unlinked colors E. Colors linked, click to unlink F. Colors unlinked, click to relink

- 1 In the Edit Colors/Recolor Artwork dialog box, select the color group you want to edit and click Edit.
- 2 Click the Unlink Harmony Colors icon .
- 3 Do one of the following in either the color wheel or color bar view:
 - Drag the color marker you want to edit to set a new color.
 - Click the color bar or color marker you want to change and manually edit the color values.
 - Double-click (or right-click) the color bar or marker and choose a new color in the Color Picker.
 - Right-click a color marker or color bar and pick a new shade.
- 4 To relink the colors so that the markers move again according to the newly defined harmony rule, click the Link Harmony Colors button.



Edit colors in a color group using the Color Picker

You can use the Color Picker to change colors in a color group.

- 1 In the Edit Colors/Recolor Artwork dialog box, do one of the following:
 - Double-click a wheel marker or right-click a wheel marker and choose Color Picker.
 - Double-click a color bar.
 - Click the color swatch to the left of the color sliders.
- 2 Save the edits by doing one of the following:
 - To save the edited colors as a new group, type a new name in the name box at the top of the dialog box, and then click New Color Group .
 - To save the edits to the original color group, click Save Changes To Color Group .

Randomly change color order or saturation and brightness

In the Edit Colors/Recolor Artwork dialog box, you can explore random variations of the current color group by using the Randomly Assign Brightness And Saturation button and the Randomly Change Color Order button.

- 1 In the Edit Colors/Recolor Artwork dialog box, select a color group.
- 2 Click Edit, and then click Display Color Bars; or click Assign.
- 3 Do either of the following:
 - To randomly change the brightness and saturation of the current color group while retaining the hues, click Randomly Changes Saturation and Brightness .
 - To shuffle the order of the current color group, click Randomly Change Color Order . Use this button when recoloring artwork to quickly explore the different ways artwork can be recolored with the current color group.



Globally edit saturation, brightness, temperature, or luminosity

- 1 In the Edit Colors/Recolor Artwork dialog box, click Edit.
- 2 Click the Color Mode button , and choose Global Adjust.
- 3 Change the values for Saturation, Brightness, Temperature, and Luminosity.

Note: If you've limited the colors to a swatch library, any adjustments you make are limited to the library colors.

Add or remove colors in a color group

- 1 In the Edit Colors/Recolor Artwork dialog box, click Edit.
- 2 Do either of the following:
 - To add a color to the color group, right-click in the color wheel where you want to add the color and choose Add New Color. If you click the line of an existing color marker, the new marker moves with that marker.
 - To remove a color, right-click the color marker or color bar and choose Remove Color. You cannot remove the base color marker.

Note: In the color wheel, you can also use the Add Color Tool button  or the Remove Color Tool button , and then click in the color wheel on the color you want to add or remove.

 - To remove a color from a color group in the Color Groups list, expand the color group, right-click the color swatch you want to remove, and choose Remove Color.

Delete a color group

- ❖ Select a color group in the Color Groups list and click Delete . Or right-click and choose Remove Color Group.

Assign colors to your artwork

The Assign tab of the Edit Colors/Recolor Artwork dialog box lets you assign colors from a color group to your artwork. You can assign colors in the following ways:

- Assign new colors to your artwork using a color group from the Color Groups list.
- Assign new colors to your artwork using a new color group chosen from the Harmony Rules menu.
- Reassign current artwork colors among themselves. You can reset the Edit Colors/Recolor Artwork dialog box so that the artwork is displayed with its original colors by clicking Get Colors From Selected Art .

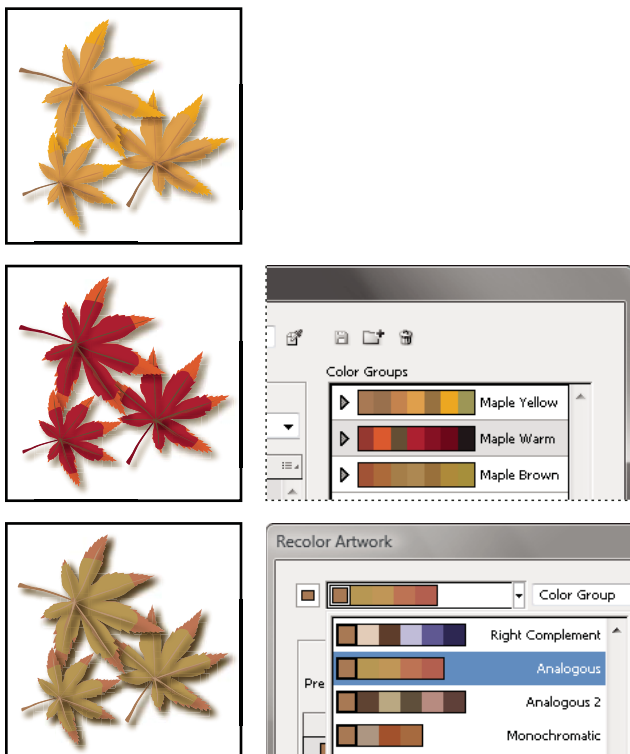

Original artwork colors (top), assigning new colors by selecting a color group in the Color Groups list (center), and assigning new colors by creating a new color group using the Harmony Rules menu (bottom).

Using the Current Colors and New columns, you control how colors are assigned. When you select Recolor Art, the selected artwork is recolored with the active color group according to the columns assignments.

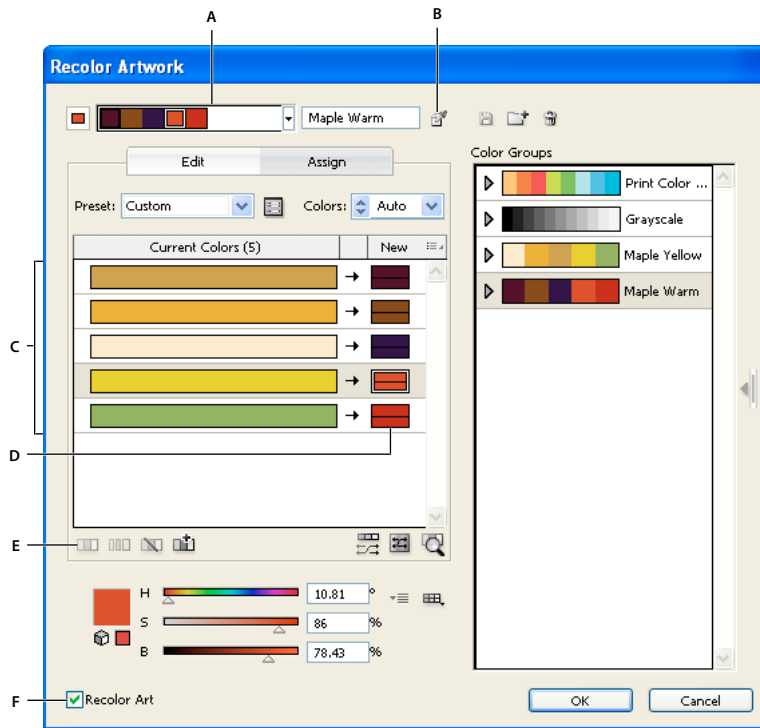

A. Active color group B. Get Colors From Selected Art C. Colors from selected artwork D. New colors from active color group E. Options for working with entire rows F. Recolor Artwork

For a video on assigning colors, see www.adobe.com/go/vid0061.

Assign new colors to selected artwork

- 1 Select the artwork you want to recolor.
- 2 Choose Edit > Edit Colors > Recolor Artwork.

The Recolor Artwork dialog box opens, displaying the Assign area with colors from the original artwork in both columns.

- 3 If you want to assign colors from a color group, do one of the following:

- a Choose a color group from the Color Groups list.
- b Create a color group by selecting a new harmony rule from the menu from the Harmony Rules menu.

Note: If you create a color group, you can click Edit to fine-tune the colors, and then click Assign. Or, if you want to adjust a few colors in the selected artwork, select the color you want to adjust and edit it with the color sliders.







- 4 To preview the color changes in your artwork, click Recolor Art.

- 5 Do any of the following to reassign colors:

- To assign a current color to a different color, drag the current color up or down in the Current Colors column until it's adjacent to the new color you want.

💡 If a row contains multiple colors and you want to move them all, click the selector bar  at the left of the row and drag up or down.

Color

- To assign a new color to a different row of current colors, drag the new color up or down in the New column. (To add a new color to or remove a color from the New column, right-click in the list and choose Add New Color or Remove Color.)
 - To change a color in the New column, right-click it and choose Color Picker to set a new color.
 - To exclude a row of current colors from being reassigned, click the arrow  between the columns. To include it again, click the dash.
 - To exclude a single current color from being reassigned, right-click the color and choose Exclude Colors, or click the icon .
 - To randomly reassign colors, click the Randomly Change Color Order button . The New colors move randomly to different rows of current colors.
 - To add a row to the Current Colors column, right-click and choose Add New Row, or click the icon .
- 6 To separate or merge colors in the Current Colors row, do either of the following:
- To separate colors into separate rows, select the color block you want to move and right-click and choose Separate Colors Into Different Rows, or click the icon .
 - To merge colors into one row, Shift-click to select multiple colors, and then right-click and choose Merge Colors Into A Row, or click the icon .
- 7 To change tints or shades of new colors, click the triangle next to the right of a new color (or right-click a color and choose Colorize Method), and choose an option. Select Apply To All if you want the same option to apply to all new colors in the color group.
- Note: Tints And Shades and Hue Shift are only available when you choose not to preserve spot colors.*
- 8 Click OK to recolor the artwork. If you don't want to recolor the artwork, click Cancel, or deselect Recolor Artwork and click OK.

Randomly change saturation and brightness in all colors

- 1 If necessary, select an object and choose Edit > Edit Colors > Recolor Artwork.
 - 2 In the Edit Colors/Recolor Artwork dialog box, click the Randomly Change Saturation and Brightness button .
- Note: You can also change saturation and brightness when editing a color group using the Color Bars display.*

View original colors in your artwork as you assign new colors

When you recolor selected artwork, the colors in the selected color group replace the original colors. When assigning new colors, it helps to see where an original color (from the Current Colors column) appears in your artwork, especially if your artwork is very detailed, or contains many original colors.

- 1 If necessary, select an object and choose Edit > Edit Colors > Recolor Artwork.
- 2 In the Recolor Artwork dialog box, click the Click On Colors Above To Find Them In Artwork button , and then click a color in the Current Colors column.

The artwork that uses that color appears in full color on the artboard while all other areas of the selected artwork are dimmed.

- 3 Click the icon again to return your artwork to full color.

Reduce colors in your artwork

Reducing colors for output, converting colors to grayscale, or limiting colors to a color library is often necessary when you create artwork intended for multiple types of output media. You can easily reduce the number of colors in your artwork using the Recolor Artwork dialog box. You can choose whether to use a preset for reducing colors, for example, you can choose Grayscale Art to quickly convert your selected artwork to grayscale.

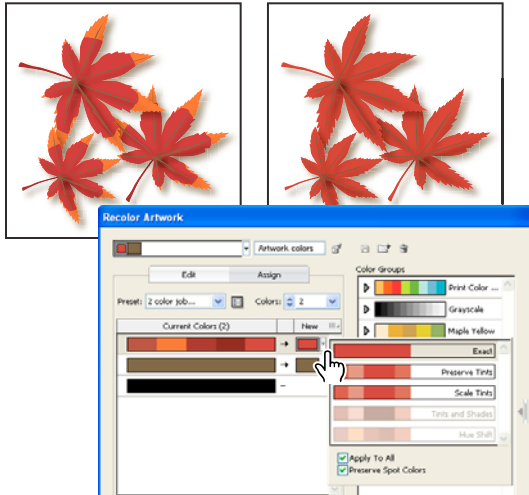

Reducing selected artwork to two colors

Quickly reduce colors using a preset

Reducing your colors by using a preset is a quick and easy way to limit your artwork to a specific number of colors or a swatch library.

- 1 Select the artwork you want to reduce.
- 2 Choose Edit > Edit Colors > Recolor With Preset, and choose a preset option.
- 3 Do one of the following:
 - If you want to limit colors to a swatch library, click the library button , select the library you want, and then click OK.
 - If you don't want to limit colors to a swatch library, click OK.

The Recolor Artwork dialog box opens. The New column displays the number of colors you chose as your preset, plus black. The new colors are taken from your original artwork.

- 4 Assign your original colors to the new colors as desired.
- 5 Make sure that Recolor Art is selected, and click OK.

Reduce colors using custom options

- 1 Select the artwork you want to recolor.
- 2 Choose Edit > Edit Colors > Recolor Artwork.

The Recolor Artwork dialog box opens. The New column displays all the colors from your selected artwork.
- 3 To use different colors, select or create a color group.
- 4 Choose the number of colors you want to reduce down to from the Colors menu.

5 Click the Color Reduction Options button , specify any of the following options, and click OK:

Preset Specifies a preset color job, including the number of colors used and optimal settings for that job. If you select a preset and then change any of the other options, the preset changes to *Custom*.

Colors Specifies the number of new colors that the current colors are reduced to.

Limit To Library Specifies a swatch library from which all new colors are derived.

Sort Determines how the original colors are sorted in the Current Colors column.

Colorize Method Specifies the types of variations allowed for the new colors.

- **Exact** exactly replaces each current color with the specified new color.
- **Scale Tints** (default option) replaces the darkest current color in the row with the specified new color. Other current colors in the row are replaced with a proportionally lighter tint.
- **Preserve Tints** is the same as Scale Tints for non-global colors. For spot or global colors, it applies the current color's tint to the new color. Use Preserve Tints when all the current colors in the row are tints of the same or similar global color. For best results when using Preserve Tints, also select Combine Tints.
- **Tints And Shades** replaces the current color with the average lightness and darkness with the specified new color. Current colors that are lighter than the average are replaced with a proportionally lighter tint of the new color. Current colors that are darker than the average are replaced by adding black to the new color.
- **Hue Shift** sets the most typical color in the Current Colors row as a key color and exactly replaces the key color with the new color. The other current colors are replaced by colors that differ from the new color in brightness, saturation, and hue by the same amounts that the current color differs from the key color.

Combine Tints Sorts all tints of the same global color into the same Current Colors row, even if colors are not being reduced. Use this option only when the selected art contains global or spot colors applied at tints less than 100%. For best results, use in combination with the Preserve Tints colorization method.

***Note:** Even when Combine Tints is not selected, color reduction combines tints of the same global color before it combines different non-global colors.*

Preserve Determines whether white, black, or gray is preserved in the final reduction. If a color is preserved, it appears in the Current Colors column as an excluded row.

6 Assign current colors to the new colors as desired.

7 Make sure that Recolor Art is selected, and click OK.

Kuler panel

About Kuler

The Kuler™ panel is your portal to groups of colors, or themes, created by an online community of designers. You can use it to browse thousands of themes on Kuler, and then download some to edit or to include in your own projects. You can also use the Kuler panel to share your themes with the Kuler community by uploading them.

The Kuler panel is available in Adobe Photoshop® CS5, Adobe Flash® Professional CS5, Adobe InDesign® CS5, Adobe Illustrator® CS5, and Adobe Fireworks® CS5. The panel is not available in the French versions of these products.

For a video on the Kuler panel, see www.adobe.com/go/lrvid4088_xp.

For an article on Kuler and color inspiration, see Veerle Pieters' blog at http://veerle.duoh.com/blog/comments/adobe_Kuler_update_and_color_tips/.

View and use themes

An Internet connection is required to browse themes online.

Search and view themes

- 1 Select Window > Extensions > Kuler.
- 2 In the Search box, enter the name of a theme, a tag, or a creator.
Note: Use only alphanumerical characters (Aa-Zz, 0-9) in searches.
- 3 Filter the search results by selecting an option from the pop-up menus above the results.
- 4 To view the next or previous set of themes, click the View Previous Set Of Themes or View Next Set Of themes icon at the bottom of the Kuler panel.
- 5 To refresh the view with the latest themes from the Kuler community, click the Refresh The Themes From The Kuler Community icon at the bottom of the panel.

View a theme online on Kuler

- 1 Select a theme in the search results.
- 2 Click the triangle on the right side of the theme and select View Online in Kuler.

Saving frequent searches

- 1 Select Custom in the first pop-up menu located directly under the Search box.
- 2 In the dialog box that opens, enter your search terms and click Save.

When you want to run the search, select it from the first pop-up menu.

To delete a saved search, select the Custom option in the pop-up menu and clear the searches you'd like to delete.

Add a theme to the Swatches panel in Illustrator

- ❖ Select the theme and click the Add Selected Theme To Swatches icon at the bottom of the Kuler panel.

Upload your theme to Kuler community

- 1 Select the theme in the Swatches panel.
- 2 In the Kuler panel, click the Upload From Swatch Panel To Kuler Community icon.

Adjusting colors

Shift an out-of-gamut color to a printable color

Some colors in the RGB and HSB color models, such as neon colors, cannot be printed, because they have no equivalents in the CMYK model. If you select an out-of-gamut color, an alert triangle  appears in the Color panel or Color Picker.

- ❖ Click the triangle to shift to the closest CMYK equivalent (which is displayed in a small box by the triangle).

More Help topics

[“Color spaces and gamuts”](#) on page 116

Shift a color to a web-safe color

Web-safe colors are the 216 colors used by all browsers, regardless of the platform. If you select a color that is not web-safe, an alert cube  appears in the Color panel, Color Picker, or Edit Colors/Recolor Artwork dialog box.

- ❖ Click the cube to shift to the closest web-safe color (which is displayed in a small box by the cube).

More Help topics

“[About web graphics](#)” on page 385

Blend colors

The Blend commands create a series of intermediate colors from a group of three or more filled objects, based on the objects’ vertical or horizontal orientation, or on their stacking order. Blending does not affect strokes or unpainted objects.

- 1 Select three or more filled objects.
- 2 Do one of the following:
 - To fill the intermediate objects with graduated blends between the frontmost and backmost filled objects, choose Edit > Edit Colors > Blend Front To Back.
 - To fill the intermediate objects with graduated blends between the leftmost and rightmost filled objects, choose Edit > Edit Colors > Blend Horizontally.
 - To fill the intermediate objects with graduated blends between the topmost and bottommost filled objects, choose Edit > Edit Colors > Blend Vertically.

Change a color to its inverse or complement

- 1 Select the color you want to change.
- 2 In the Color panel, select an option from the panel menu:

Invert Changes each component of a color to the opposite value on the color scale. For example, if an RGB color has an R value of 100, the Invert command will change the R value to 155 ($255 - 100 = 155$).

Complement Changes each component of a color to a new value based on the sum of the highest and lowest RGB values in the selected color. Illustrator adds the lowest and highest RGB values of the current color, and then subtracts the value of each component from that number to create new RGB values. For example, suppose you select a color with an RGB value of 102 for red, 153 for green, and 51 for blue. Illustrator adds the high (153) and low (51) values, to end up with a new value (204). Each of the RGB values in the existing color is subtracted from the new value to create new complementary RGB values: $204 - 102$ (the current red value) = 102 for the new red value, $204 - 153$ (the current green value) = 51 for the new green value, and $204 - 51$ (the current blue value) = 153 for the new blue value.

Change the tint of a color

- 1 Select a global process color or spot color in the Swatches panel, or select an object to which you’ve applied a global process color or spot color.
- 2 In the Color panel, drag the T slider or enter a value in the text box to modify the color’s intensity. The tint range is from 0% to 100%; the lower the number, the lighter the tint will be.



If you don’t see the T slider, make sure that you have a global process color or spot color selected. If you still don’t see the T slider, choose Show Options from the Color panel menu.

- 3 To save the tint as a swatch, drag the color to the Swatches panel, or click the New Swatch button in the Swatches panel. The tint is saved with the same name as the base color, but with the tint percentage added to the name. For example, if you saved a color named “Sky Blue” at 50 percent, the swatch name would be “Sky Blue 50%.”

More Help topics

“[About spot colors](#)” on page 117

“[About process colors](#)” on page 117

Adjust color balance of one or more colors

- 1 Select the objects whose colors you want to adjust.
- 2 Choose Edit > Edit Colors > Adjust Color Balance.
- 3 Set the Fill and Stroke options.
- 4 Adjust the color values, and then click OK:
 - If you selected any global process colors or spot colors, use the tint slider to adjust the intensity of the colors. Any nonglobal process colors you selected are not affected.
 - If you are working in CMYK color mode and selected nonglobal process colors, use the sliders to adjust the percentages of cyan, magenta, yellow, and black.
 - If you are working in RGB color mode and selected nonglobal process colors, use the sliders to adjust the percentages of red, green, and blue.
 - If you want to convert the colors you selected to grayscale, select Grayscale from the Color Mode list and select the Convert option. Then use the slider to adjust the percentage of black.
 - If you selected any global process or spot colors and you want to convert them to nonglobal process colors, select either CMYK or RGB from the Color Mode list (depending on the color mode of the document) and select the Convert option. Then use the sliders to adjust the colors.

Invert multiple colors

- 1 Select the objects whose colors you want to invert.
- 2 Choose Edit > Edit Colors > Invert Colors.

 *You can use the Color panel to invert individual colors.*

Change the color mode of a document

- ❖ Choose File > Document Color Mode > CMYK Color or RGB Color.

Display and output spot colors using Lab values

Some predefined spot colors, such as colors from the TOYO, PANTONE, DIC, and HKS libraries, are defined using Lab values. For backward compatibility with previous versions of Illustrator, colors from these libraries also include CMYK definitions. The Swatches panel lets you control which values, Lab or CMYK, Illustrator uses to display, export, and print these spot colors.

Lab values, when used in conjunction with the correct device profiles, give you the most accurate output across all devices. If color management is critical to your project, Adobe recommends that you display, export, and print spot colors using their Lab values.

Note: To improve on-screen accuracy, Illustrator uses the Lab values automatically if Overprint Preview is on. It also uses Lab values when printing if you've selected Simulate for the Overprints option in the Advanced area of the Print dialog box.

- 1 Choose Spot Colors from the Swatches panel menu.
- 2 Do one of the following:
 - Select Use Standard Lab Values Specified By The Book Manufacturer if you want the most accurate display and output of colors.
 - Select Use CMYK Values From The Manufacturer's Process Book if you want spot colors to match earlier versions of Illustrator.

More Help topics

[“Lab”](#) on page 115

Convert colors to grayscale

- 1 Select the objects whose colors you want to convert.
- 2 Choose Edit > Edit Colors > Convert To Grayscale.



Use the Edit > Edit Colors > Adjust Colors command to convert objects to grayscale and adjust the shades of gray at the same time.

More Help topics

[“Grayscale”](#) on page 116

Convert grayscale images to RGB or CMYK

- 1 Select the grayscale image.
- 2 Choose Edit > Edit Colors > Convert To CMYK or Convert To RGB (depending on the color mode of the document).

Colorize grayscale or 1-bit images

- 1 Select the bitmap object.
- 2 Make sure the Fill button in the Tools panel or Color panel is selected.
- 3 Use the Color panel to color the image with black, white, a process color, or a spot color.

Note: If a grayscale image contains an alpha channel, you cannot colorize the image with a process color. Select a spot color instead.

Adjust the saturation of multiple colors

- 1 Select the objects whose colors you want to adjust.
- 2 Choose Edit > Edit Colors > Saturate.

- 3 Enter a value from –100% to 100% to specify the percentage by which to decrease or increase the color or the spot-color tint.

More Help topics

[“HSB”](#) on page 115

Mix overlapping colors

You can use blending modes, the Hard Mix effect, or the Soft Mix effect to mix overlapping colors.

Blending modes Provide many options for controlling overlapping colors, and should always be used in place of Hard Mix and Soft Mix for artwork containing spot colors, patterns, gradients, text, or other complex artwork.

Hard Mix effect Combines colors by choosing the highest value of each of the color components. For example, if Color 1 is 20% cyan, 66% magenta, 40% yellow, and 0% black; and Color 2 is 40% cyan, 20% magenta, 30% yellow, and 10% black, the resulting hard color is 40% cyan, 66% magenta, 40% yellow, and 10% black.

Soft Mix effect Makes the underlying colors visible through the overlapping artwork, and then divides the image into its component faces. You specify the percentage of visibility you want in the overlapping colors.

You can apply blending modes to individual objects, whereas you must apply the Hard Mix and Soft Mix effects to entire groups or layers. Blending modes affect both the fill and stroke of an object, whereas the Hard and Soft Mix effects result in removal of an object’s stroke.

***Note:** In most cases, applying the Hard Mix or Soft Mix effect to objects painted using a mix of process and spot colors converts the color to CMYK. In the case of mixing a non-global process RGB color with a spot RGB color, all spot colors are converted to a non-global process RGB color.*

More Help topics

[“Apply Pathfinder effects”](#) on page 241

[“About blending modes”](#) on page 186

[“Targeting items for appearance attributes”](#) on page 363

Mix colors using the Hard Mix effect

- 1 Target the group or layer.
- 2 Choose Effect > Pathfinder > Hard Mix.

Mix colors using the Soft Mix effect

- 1 Target the group or layer.
- 2 Choose Effect > Pathfinder > Soft Mix.
- 3 Enter a value between 1% and 100% in the Mixing Rate text box to determine the percentage of visibility you want in the overlapping colors, and click OK.

Chapter 5: Painting

About painting

To help you add visual interest to your artwork, Adobe Illustrator provides calligraphic, scatter, art, pattern, and bristle brushes. In addition, you can use the Live Paint feature and Shape Builder tools, to paint different path segments and fill enclosed paths with different colors, patterns, or gradients. Using the Shape Builder tool, you can create new complex new shapes by merging simple shapes. Using opacity, masks, gradients, blends, meshes, and patterns provides limitless opportunities for creativity. The Width tool provides the ability to create strokes with variable width that make very articulate outlines.

Painting with fills and strokes

Painting methods

Illustrator provides two methods of painting: assigning a fill, stroke, or both to an entire object, and converting the object to a Live Paint group and assigning fills or strokes to the separate edges and faces of paths within it.

Paint an object

After you draw an object, you assign a fill, stroke, or both to it. You can then draw other objects that you can paint similarly, layering each new object on top of the previous ones. The result is something like a collage made out of shapes cut from colored paper, with the look of the artwork depending on which objects are on top in the stack of layered objects.

For a video on using brushes, see www.adobe.com/go/vid0044.

Paint a Live Paint group

With the Live Paint method, you paint more like you would with a traditional coloring tool, without regard to layers or stacking order, which can make for a more natural workflow. All objects in a Live Paint group are treated as if they are part of the same flat surface. This means you can draw several paths and then color separately each area enclosed by these paths (called a *face*). You can also assign different stroke colors and weights to portions of a path between intersections (called an *edge*). The result is that, much like a coloring book, you can fill each face and stroke each edge with a different color. As you move and reshape paths in a Live Paint group, the faces and edges automatically adjust in response.

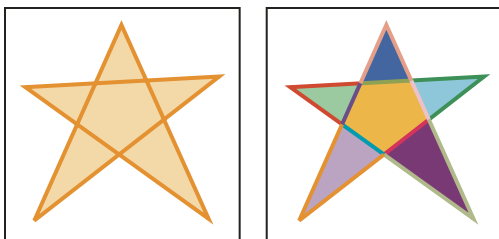

An object consisting of a single path painted with the existing method has a single fill and a single stroke (left). The same object converted to a Live Paint group can be painted with a different fill for each face and a different stroke for each edge (right).

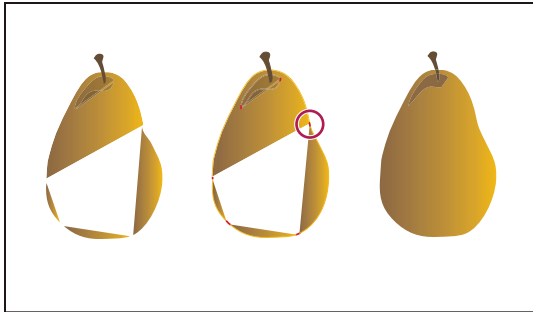

Painting an object the traditional way leaves some areas that cannot be filled (left). Painting a Live Paint group with gap detection (center) lets you avoid gaps and overprinting (right).

For a video on using Live Paint, see www.adobe.com/go/vid0042. For a video on painting techniques with the Paintbrush tool, see www.adobe.com/go/vid0038.

More Help topics

“[About Live Paint](#)” on page 160

About fills and strokes

A *fill* is a color, pattern, or gradient inside an object. You can apply fills to open and closed objects and to faces of Live Paint groups.

A *stroke* can be the visible outline of an object, a path, or the edge of a Live Paint group. You can control the width and color a stroke. You can also create dashed strokes using Path options, and paint stylized strokes using brushes.

Note: When working with Live Paint groups, you can apply a brush to an edge only if you add a stroke to the group using the Appearance panel.

The current fill and stroke colors are displayed in the Tools panel.

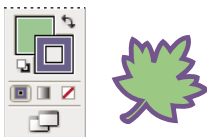

Fill and Stroke controls

More Help topics

“[Keys for painting objects](#)” on page 479

“[Select colors using the Color Picker](#)” on page 120

Fill and Stroke controls

Controls for setting the fill and stroke are available in the Tools panel, the Control panel, and the Color panel.

You can use any of the following controls in the Tools panel to specify color:

Fill button  Double-click to select a fill color using the Color Picker.

Stroke button  Double-click to select a stroke color using the Color Picker.

Swap Fill And Stroke button  Click to swap colors between the fill and stroke.

Default Fill And Stroke button  Click to return to the default color settings (white fill and black stroke).

Color button  Click to apply the last-selected solid color to an object with a gradient fill or no stroke or fill.

Gradient button  Click to change the currently selected fill to the last-selected gradient.

None button  Click to remove the selected object's fill or stroke.

You can also specify color and stroke for a selected object by using the following controls in the Control panel:

Fill color Click to open the Swatches panel or Shift-click to open an alternate color mode panel, and choose a color.

Stroke color Click to open the Swatches panel or Shift-click to open an alternate color mode panel, and choose a color.

Stroke panel Click the word Stroke to open the Stroke panel and specify options.

Stroke weight Choose a stroke weight from the pop-up menu.

Apply a fill color to an object

You can apply one color, pattern, or gradient to an entire object, or you can use Live Paint groups and apply different colors to different faces within the object.

- 1 Select the object.
- 2 Click the Fill box in the Tools panel or the Color panel. Doing so indicates that you want to apply a fill rather than a stroke.



Fill Stroke

- 3 Select a fill color by doing one of the following:
 - Click a color in the Control panel, Color panel, Swatches panel, Gradient panel, or a swatch library.
 - Double-click the Fill box and select a color from the Color Picker.
 - Select the Eyedropper tool and Alt-click (Windows) or Option-click (Mac OS) an object to apply the current attributes, including the current fill and stroke.
 - Click the None button  to remove the object's current fill.

 You can quickly apply color to an unselected object by dragging a color from the Fill box, Color panel, Gradient panel, or Swatches panel onto the object. Dragging does not work on Live Paint groups.

More Help topics

[“Select items in Live Paint groups”](#) on page 164

[“Paint with the Live Paint Bucket tool”](#) on page 166

Stroke an object

You use the Stroke panel (Window > Stroke) to specify whether a line is solid or dashed, the dash sequence and other dash adjustments if it is dashed, the stroke weight, the stroke alignment, the miter limit, arrowheads, width profiles, and the styles of line joins and line caps.

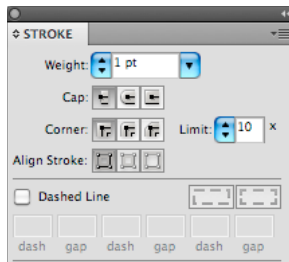
Painting*Stroke panel*

You can apply stroke options to an entire object, or you can use Live Paint groups and apply different strokes to different edges within the object.

More Help topics

[“Workspace overview”](#) on page 5

[“Select items in Live Paint groups”](#) on page 164

[“Paint with the Live Paint Bucket tool”](#) on page 166

Apply a stroke color, width, or alignment

- 1 Select the object. (To select an edge in a Live Paint group, use the Live Paint Selection tool.)
- 2 Click the Stroke box in the Tools panel, the Color panel, or the Control panel. Doing so indicates that you want to apply a stroke rather than a fill.

*Stroke box*

- 3 Select a color from the Color panel, or a swatch from the Swatches panel or Control panel. Alternatively, double-click the Stroke box to select a color using the Color Picker.





If you want to use the current color in the Stroke box, you can simply drag the color from the Stroke box onto the object. Dragging does not work on Live Paint groups.

- 4 Select a weight in the Strokes panel or Control panel.
- 5 If the object is a closed path (and not a Live Paint group), choose an option from the Stroke panel to align the stroke along the path:
 - Align Stroke To Center
 - Align Stroke To Inside
 - Align Stroke To Outside

Note: *If you try to align paths that use different stroke alignments, the paths may not exactly align. Make sure the path alignment settings are the same if you need the edges to match up exactly when aligned.*

Create dotted or dashed lines

You can create a dotted or dashed line by editing an object's stroke attributes.

- 1 Select the object.
- 2 In the Stroke panel, select Dashed Line. If the Dashed Line option isn't showing, choose Show Options from the Stroke panel menu.
- 3 Click the icon: Align Dashes to Corners and Path Ends, Adjusting Length to Fit . This option allows you to make the dashes at the corners and ends of the paths consistent and predictable. If you need to retain the appearance of the dashes without aligning then select the Preserve exact dash and gap lengths  icon.

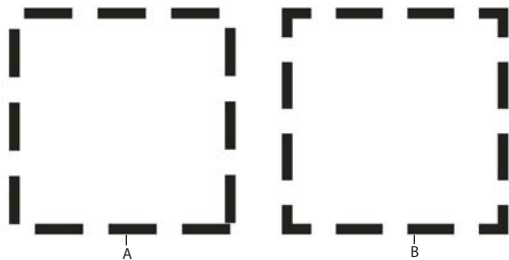



Dash Adjustments at the corners

A. Preserved exact dash and gap lengths B. Aligned dashes to corners and path ends, adjusting lengths to fit

- 4 Specify a dash sequence by entering the lengths of dashes and the gaps between them.

The numbers entered are repeated in sequence so that once you have established the pattern, you don't need to fill in all the text boxes.

- 5 Select a cap option to change the ends of the dashes. The Butt Cap  option creates square-ended dashes; the Round Cap  option creates rounded dashes or dots; the Projecting Cap  option extends the ends of dashes.

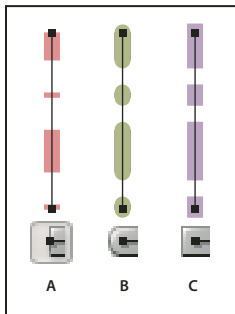

6-point dashed lines with dash gaps of 2, 12, 16, 12

A. Butt cap B. Round cap C. Projecting cap

For a video on creating perfectly dashed strokes, see www.adobe.com/go/lrvid5213_ai_en.

Change the caps or joins of a line

A *cap* is the end of an open line; a *join* is where a straight line changes direction (turns a corner). You can change the caps and joins of a line by changing the object's stroke attributes.

- 1 Select the object.
- 2 In the Stroke panel, select a cap option and a join option.

If the options aren't showing, choose Show Options from the panel menu.

Butt Cap  Creates stroked lines with squared ends.

Round Cap  Creates stroked lines with semicircular ends.

Projecting Cap  Creates stroked lines with squared ends that extend half the line width beyond the end of the line. This option makes the weight of the line extend equally in all directions around the line.

Miter Join  Creates stroked lines with pointed corners. Enter a miter limit between 1 and 500. The miter limit controls when the program switches from a mitered (pointed) join to a beveled (squared-off) join. The default miter limit is 10, which means that when the length of the point reaches ten times the stroke weight, the program switches from a miter join to a bevel join. A miter limit of 1 results in a bevel join.

Round Join  Creates stroked lines with rounded corners.

Bevel Join  Creates stroked lines with squared corners.

Add arrowheads

In Illustrator CS5, you can access arrowheads from the Stroke panel and associate controls to adjust size. Default arrowheads are available from the Arrowheads drop-down list in the Stroke panel. Using the Stroke panel, you can also easily swap arrowheads.

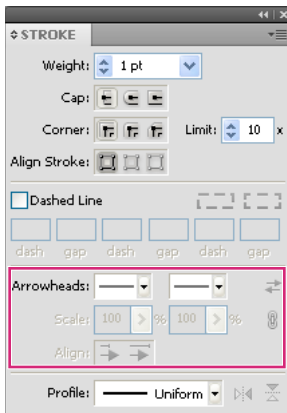

Arrowheads in Stroke panel

You can resize the tip and end of the arrowheads independently, using Scale option. If you want to link the start and end of the arrowheads scale, click the Link Start and End of Arrowheads Scales icon, adjacent to the Scale option.

You can also adjust the path to align to the tip or the end of the arrowhead, using the Align options. The options are:

- Extend arrow tip beyond end of path
- Place arrow tip at the end of path

Note: To remove arrowheads from objects, choose the None arrowhead option from the drop-down list.

Customize arrowheads

To define custom arrowheads, open the Arrowheads.ai file, which is located under ShowPackageContent\Required\Resources\<locale>\ (for Mac) and \Support Files\Required\Resources\<locale>\ (for Windows). Follow the instructions in the file to create custom arrowheads.

Place the updated Arrowheads.ai file at: <Illustrator home>\Plug-ins\ and avoid replacing the existing Arrowheads.ai file.

Draw and merge paths with the Blob Brush tool

Use the Blob Brush tool to paint filled shapes that you can intersect and merge with other shapes of the same color.

The Blob Brush tool uses the same default brush options as calligraphic brushes. (See “[Calligraphic brush options](#)” on page 173.)

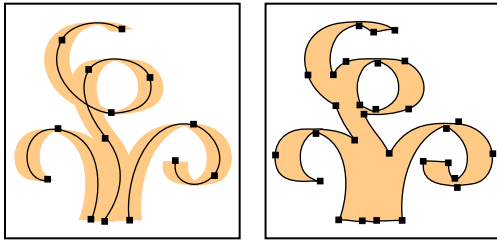

Path created with a Calligraphy brush (left); path created with the Blob Brush tool (right)

To see a video on using the Blob Brush tool, see www.adobe.com/go/lrvid4018_ai. To see an example of using the Blob Brush to create a complex drawing, see www.adobe.com/go/learn_ai_tutorials_blob_brush_en.

More Help topics

“[Paintbrush tool options](#)” on page 171

Blob Brush tool guidelines

When using the Blob Brush tool, keep the following guidelines in mind:

- To merge paths, they must be adjacent in stacking order.
- The Blob Brush tool creates paths with a fill and no stroke. If you want your Blob Brush paths to merge with existing artwork, make sure that the artwork has the same fill color and no stroke.
- When drawing paths with the Blob Brush tool, new paths merge with the topmost matching path encountered. If the new path touches more than one matching path within the same group or layer, all of the intersecting paths are merged together.
- To apply paint attributes (such as effects or transparency) to the Blob Brush tool, select the brush and set the attributes in the Appearances panel before you start drawing.
- You can use the Blob Brush tool to merge paths created by other tools. To do this make sure that the existing artwork does not have a stroke; then set up the Blob Brush tool to have the same fill color, and draw a new path that intersects all of the paths that you want to merge together.

Create merged paths

Remember that paths with strokes cannot be merged.

- 1 Select the path into which you want to merge a new path.
- 2 In the Appearances panel, deselect New Art Has Basic Appearance. When this option is deselected, the Blob Brush tool uses the attributes of the selected artwork.
- 3 Select the Blob Brush tool , and make sure it uses the same appearances as the selected artwork.

- 4 Draw paths that intersect with the artwork. If the paths don't merge, check to make sure that the Blob Brush tool's attributes exactly match the existing path attributes, and that neither uses a stroke.

Blob Brush tool options

Double-click the Blob Brush tool in the Tools panel and set any of the following options:

Keep Selected Specifies that when you draw a merged path, all paths are selected and remain selected as you continue to draw. This option is useful for viewing all paths that are included in the merged path.

Merge only with Selection Specifies that new strokes merge only with the existing selected path. If you select this option, the new stroke is not merged with another intersecting path that is not selected.

Fidelity Controls how far you have to move your mouse or stylus before Illustrator adds a new anchor point to the path. For example, a Fidelity value of 2.5 means that tool movements of less than 2.5 pixels aren't registered. Fidelity can range from 0.5 to 20 pixels; the higher the value, the smoother and less complex the path.

Smoothness Controls the amount of smoothing that Illustrator applies when you use the tool. Smoothness can range from 0% to 100%; the higher the percentage, the smoother the path.

Size Determines the size of the brush.

Angle Determines the angle of rotation for the brush. Drag the arrowhead in the preview, or enter a value in the Angle text box.

Roundness Determines roundness of the brush. Drag a black dot in the preview away from or toward the center, or enter a value in the Roundness text box. The higher the value, the greater the roundness.

Convert strokes to compound paths

Converting a stroke to a compound path lets you modify the outline of the stroke. For example, you can create a stroke with a varied width or divide the stroke into pieces.

- 1 Select the object.
- 2 Choose Object > Path > Outline Stroke.

The resulting compound path is grouped with the filled object. To modify the compound path, first ungroup it from the fill or select it with the Group Selection tool.



Use the Layers panel to identify the contents of a group.

More Help topics

[“About compound paths”](#) on page 244

[“Group or ungroup objects”](#) on page 210

Remove the fill or stroke from an object

- 1 Select the object.
- 2 Click the Fill box or the Stroke box in the Tools panel. Doing so indicates whether you want to remove the object's fill or its stroke.
- 3 Click the None button in the Tools panel, the Color panel, or the Swatches panel.

Note: You can also click the None icon in the Fill menu or the Stroke Color menu in the Control panel.

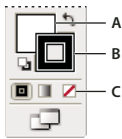

Fill and Stroke boxes

A. Fill box B. Stroke box C. None button

Select objects with the same fill and stroke

You can select objects that have the same attributes, including fill color, stroke color, and stroke weight.

Note: The *Select > Same > Fill Color*, *Stroke Color*, and *Stroke Weight* commands work within a Live Paint group when you select a face or edge with the Live Paint Selection tool; other *Select > Same* commands do not work. You cannot select same objects both inside and outside a Live Paint group at the same time.

- To select objects with the same fill and stroke, select one of the objects, click the Select Similar Objects button  in the Control panel and choose what you want to base your selection on in the menu that appears.
- To select all objects with the same fill or stroke color, select an object with that fill or stroke color, or choose the color from the Color panel or Swatches panel. Then choose *Select > Same* and click Fill Color, Stroke Color, or Fill & Stroke on the submenu.
- To select all objects with the same stroke weight, select an object with that stroke weight or choose the stroke weight from the Stroke panel. Then choose *Select > Same > Stroke Weight*.
- To apply the same selection options using a different object (for example, if you have already selected all red objects using the *Select > Same > Fill Color* command and now you want to search for all green objects), select a new object and then choose *Select > Reselect*.

 To consider the tint of an object when selecting based on color, choose *Edit > Preferences > General (Windows)* or *Illustrator > Preferences > General (Mac OS)*, and then choose *Select Same Tint %*. With this option selected, if you select an object filled with a 50% tint of PANTONE Yellow C and choose *Select > Same > Fill Color*, Illustrator selects only those objects filled with a 50% tint of that color. With this option deselected, objects with any tint of PANTONE Yellow C are selected.

Create multiple fills and strokes

You use the Appearance panel to create multiple fills and strokes for the same object. Adding multiple fills and strokes to an object is the basis for creating many interesting effects. For example, you can create a second, narrower stroke on top of a wide stroke, or you can apply an effect to one fill but not the other.

- 1 Select one or more objects or groups (or target a layer in the Layers panel).
- 2 Select Add New Fill or Add New Stroke from the Appearance panel menu. Alternatively, select a fill or stroke in the Appearance panel, and click the Duplicate Selected Item button .
- 3 Set the color and other properties for the new fill or stroke.

Note: It may be necessary to adjust the position of the new fill or stroke in the Appearance panel. For example, if you create two strokes of different widths, make sure that the narrower stroke is above the wider stroke in the Appearance panel.

More Help topics

[“Targeting items for appearance attributes”](#) on page 363

[“Appearance panel overview”](#) on page 362

Create strokes with variable widths

About the Width tool

The Width tool is available from the Tools panel. It allows you to create a variable width stroke and save the variable width as a profile that can be applied to other strokes.

When you mouse over a stroke with the Width tool, a hollow diamond appears on the path with handles. You can adjust the stroke width, move the width point, duplicate the width point, and delete the width point.

For multiple strokes, the width tool adjusts only the active stroke. If you want to adjust a stroke, make sure that you select it as the active stroke in the Appearance panel.

For a video on using the Width tool, see www.adobe.com/go/lrvid5206_ai_en.

Using the Width tool

To create or modify a width point using the Width Point Edit dialog box, double-click the stroke using the Width tool and edit the values for the width point. If you select the Adjust Adjoining Width Points option, changes to the selected width point affect neighboring width points as well.

If you press Shift and double-click the width point, then this check box is selected automatically.

The Width tool distinguishes between continuous and discontinuous width points while adjusting variable width.

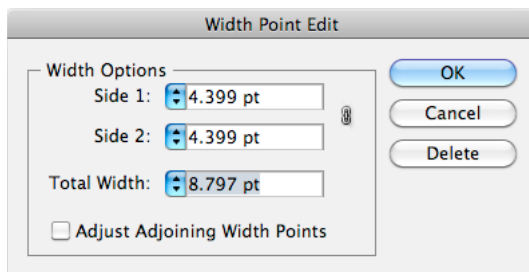

Width Point Edit dialog box for continuous points

To create a discontinuous width point do the following:

- 1 Create two width points on a stroke with different stroke widths.

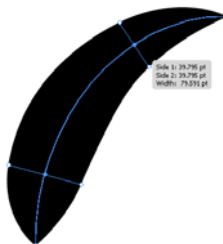

Two points with different stroke width

- 2 Drag one width point on to the other width point to create a discontinuous width point for the stroke.

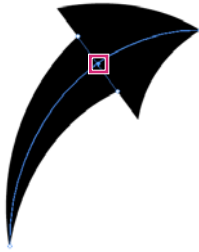

Discontinuous width point created by dragging one width point on to the other width point.

For discontinuous points, the Width Point Edit dialog box shows both sets of side widths.

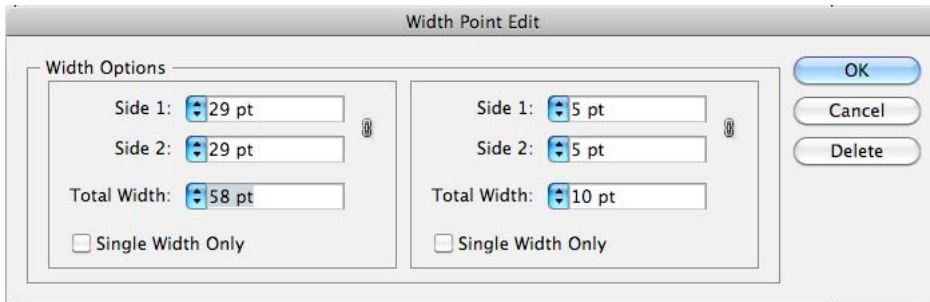

Width Point Edit dialog box for discontinuous points

The Single Width Only check boxes allow using either incoming or outgoing width leaving a single continuous width point.

Width tool controls

The following table lists the keyboard modifiers to use while working with the Width tool:

Width control tasks	Keyboard modifiers
Create non-uniform widths	Alt+drag (Windows) or Opt+drag (Mac OS)
Create a copy of the width point	Alt+drag the width point (Windows) or Opt+drag the width point (Mac OS)
Copy and move all the points along the path	Alt+Shift+drag (Windows) or Opt+Shift+drag (Mac OS)
Change the position of multiple width points	Shift+drag
Select multiple width points	Shift+click
Delete selected width points	Delete
Deselect a width point	Esc

You can drag the handles outward or inward to adjust the stroke width at that location on the path. Width points created at a corner or at a direct-selected anchor point, stick to the anchor point during basic editing of the path.

To change the position of the width point, drag the point along the path.

To select multiple width points, press Shift and click. The Width Point Edit dialog box is displayed, where you can specify values for Side1 and Side 2 of multiple points. Any adjustment to the width points, would impact all the selected width points.

You can also globally adjust the stroke weight for all the width points by specifying the stroke weight in the Weight drop-down list of the Stroke panel.

Saving width profiles

After defining the stroke width, you can save the variable width profile from the Stroke panel or the Control panel.

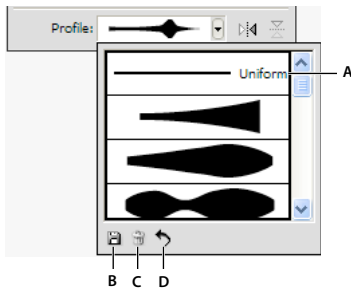

A. Uniform Width Profile option B. Save Width Profile icon C. Delete Width Profile icon D. Reset Width Profile icon

Width profiles can be applied to selected paths by choosing them from the Width Profile drop-down list in the Control panel or Stroke panel. When a stroke with no variable width is selected, the list displays the Uniform option. You can also select the Uniform option to remove a variable width profile from an object.

To restore the default width profile set, click the Reset Profiles button at the bottom of the Profile drop down list.

Note: Restoring the default width profile set in the Stroke Options dialog box, removes any custom saved profiles.

If you apply a variable width profile to a stroke, then it is indicated with an asterisk (*) in the Appearance panel.

For Art and Pattern brushes, the Width Points/Profile option is automatically selected for size in Stroke Options dialog box after editing a brush path with the Variable Width tool or applying a Width Profile preset. To remove any width profile changes, select the Fixed option for size or one of the tablet data channels, such as Pressure, to restore the tablet data options.

For a video on creating variable width profiles, see www.adobe.com/go/lrvid5215_ai_en.

Live Paint groups

About Live Paint

Converting your artwork to Live Paint groups allows you to color them freely, as you would a drawing on canvas or paper. You can stroke each path segment with a different color and fill each enclosed path (note, not just closed paths) with a different color, pattern, or gradient.

Live Paint is an intuitive way to create colored drawings. It lets you use the full range of Illustrator's vector drawing tools, but treats all the paths you draw as though they are on the same flat surface. That is, none of the paths is behind or in front of any other. Instead, the paths divide the drawing surface up into areas, any of which can be colored, regardless of whether the area is bounded by a single path or by segments of multiple paths. The result is that painting objects is like filling in a coloring book or using watercolors to paint a pencil sketch.

Once you've made a Live Paint group, each path remains fully editable. When you move or adjust a path's shape, the colors that had been previously applied don't just stay where they were, like they do in natural media paintings or image editing programs. Instead, Illustrator automatically reapplies them to the new regions that are formed by the edited paths.

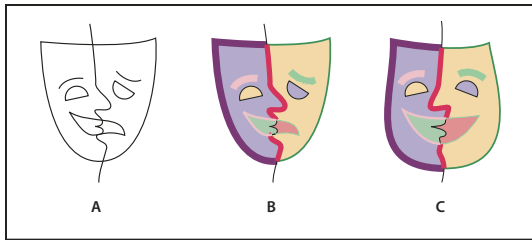

Adjusting Live Paint paths
A. Original B. Live Paint group C. Paths adjusted, Live Painting reflows

The paintable parts of Live Paint groups are called *edges* and *faces*. An edge is the portion of a path between where it intersects with other paths. A face is the area enclosed by one or more edges. You can stroke edges and fill faces.

Take, for example, a circle with a line drawn across it. As a Live Paint group, the line (edge) dividing the circle creates two faces in the circle. You can fill each face and stroke each edge with a different color using the Live Paint Bucket tool.

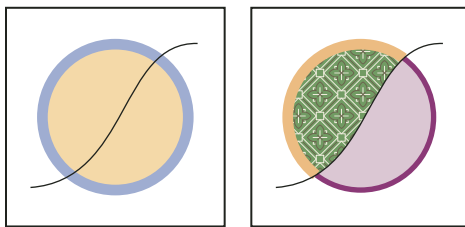

Circle and line (left) compared to circle and line after conversion to a Live Paint group and filling faces and stroking edges (right).

Note: Live Paint takes advantage of multiprocessors, which help Illustrator perform the operations more quickly.

For a video on using Live Paint, see www.adobe.com/go/vid0042.

More Help topics

“[Painting methods](#)” on page 149

“[About fills and strokes](#)” on page 150

Live Paint limitations

Fill and paint attributes are attached to faces and edges of a Live Paint group—not to the actual paths that define them, as in other Illustrator objects. Because of this, some features and commands either work differently or are not applicable to paths inside a Live Paint group.

Features and commands that work on an entire Live Paint group, but not on individual faces and edges

- Transparency
- Effects
- Multiple fills and strokes from the Appearance panel
- Object > Envelope Distort
- Object > Hide
- Object > Rasterize
- Object > Slice > Make

- Make Opacity Mask (in the Transparency panel menu)
- Brushes (You can apply brushes to an entire Live Paint group if you add a new stroke to the group using the Appearance panel.)

Features that don't work on Live Paint groups

- Gradient meshes
- Graphs
- Symbols from the Symbols panel
- Flares
- Align Stroke options from the Stroke panel
- The Magic Wand tool

Object commands that don't work on Live Paint groups

- Outline Stroke
- Expand (You can use the Object > Live Paint > Expand command instead.)
- Blend
- Slice
- Clipping Mask > Make
- Create Gradient Mesh

Other commands that don't work on Live Paint groups

- Pathfinder commands
- File > Place
- View > Guides > Make
- Select > Same > Blending Mode, Fill & Stroke, Opacity, Style, Symbol Instance, or Link Block Series
- Object > Text Wrap > Make

Create Live Paint groups

When you want to color objects using different colors for each edge, or intersection, convert the artwork into a Live Paint Group.

Certain types of objects, such as type, bitmap images, and brushes, cannot be directly made into Live Paint groups. You first need to convert these objects into paths. For example, if you try to convert an object that uses brushes or effects, the complex visual appearance is lost in the conversion to Live Paint. However, you can retain much of the appearance by first converting the objects to regular paths and then converting the resulting paths to Live Paint.

***Note:** When you convert artwork to a Live Paint group, you cannot return the artwork to its original state. You can expand the group into its individual components, or release the group back to its original paths with no fill and a .5 black stroke.*

For a video on using Live Paint, see www.adobe.com/go/vid0042.

More Help topics

“[Keys for working with Live Paint groups](#)” on page 480

Create a Live Paint group

- 1 Select one or more paths, compound paths, or both.
- 2 Do one of the following:
 - Choose Object > Live Paint > Make.
 - Select the Live Paint Bucket tool  and click the selected object.

Note: Certain properties may be lost in the conversion to a Live Paint group, such as transparency and effects, while other objects cannot be converted (such as type, bitmap images, and brushes).

Convert objects to Live Paint groups

- ❖ Do any of the following for objects that do not directly convert to Live Paint groups:
 - For type objects, choose Type > Create Outlines. Then make the resulting paths into a Live Paint group.
 - For bitmap images, choose Object > Live Trace > Make And Convert To Live Paint.
 - For other objects, choose Object > Expand. Then make the resulting paths into a Live Paint group.

Expand or release a Live Paint group

Releasing a Live Paint group changes it to one or more ordinary paths with no fill and a .5-point black stroke. Expanding a Live Paint group changes it to one or more ordinary paths that are visually similar to the Live Paint group, but are now separate filled and stroked paths. You can use the Group Selection tool to select and modify these paths separately.

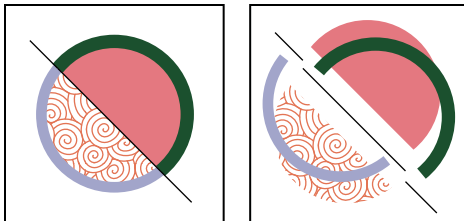

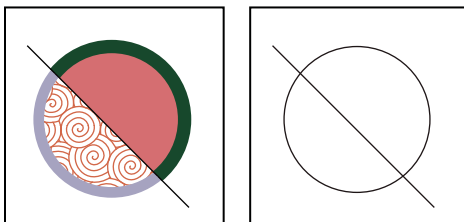

Live Paint group before (left) and after expanding and dragging to separate faces and edges (right)



Live Paint group before (left) and after Release command applied (right)

- 1 Select the Live Paint group.
- 2 Do one of the following:
 - Choose Object > Live Paint > Expand.
 - Choose Object > Live Paint > Release.

Select items in Live Paint groups



Use the Live Paint Selection tool  to select individual faces and edges in a Live Paint group. Use the Selection tool  to select the entire Live Paint group, and the Direct Selection tool  to select paths inside a Live Paint group. When you're working in a complex document, you can isolate a Live Paint group so that it is easy to select the exact face or edge you want.

 Choose a selection tool depending on what you want to affect in a Live Paint group. For example, use the Live Paint Selection tool to apply different gradients across different faces in a Live Paint group, and use the Selection tool to apply the same gradient across the entire Live Paint group.

More Help topics

[“Isolate artwork for editing”](#) on page 202

Select faces and edges

The Live Paint Selection tool pointer changes to the face pointer  when it's positioned over a face, the edge pointer  when it's positioned over an edge, or the x pointer  when it's positioned outside of a Live Paint group.

- ❖ Select the Live Paint Selection tool, and then:
 - To select an individual face or edge, click a face or edge.
 - To select multiple faces and edges, drag a marquee around the items you want to select. Partial selections are included.
 - To select all contiguous faces that are not separated by a painted edge, double-click a face.
 - To select faces or edges with the same fill or stroke, triple-click an item. Or click once, choose **Select > Same**, and then choose **Fill Color**, **Stroke Color**, or **Stroke Weight** on the submenu.
 - To add items to, or remove items from, the current selection, Shift-click or Shift-drag a marquee around the items.

Select a Live Paint group

- ❖ Using the Selection tool, click the group.

Select an original path within a Live Paint group

- ❖ Using the Direct Selection tool, click a path inside the Live Paint group.

Isolate a Live Paint group from the rest of the artwork

- ❖ Using the Selection tool, do one of the following:
 - Double-click the group.
 - Select the group, and then click the **Isolate Selected Group** button  in the Control panel.

Modify Live Paint groups

When you modify a path in a Live Paint group, Illustrator colors the modified or new faces and edges using fills and strokes from the existing group. If the results are not what you expect, you can reapply the colors you want using the Live Paint Bucket tool.

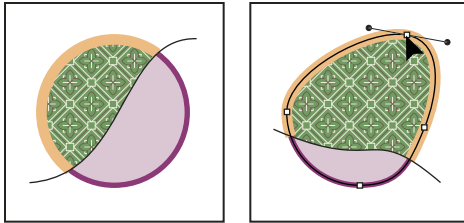

Live Paint group before (left) and after adjusting paths (right)

When you delete edges, the fill floods across any newly expanded face. For example, if you delete a path that divides a circle in half, the circle is filled with one of the fills previously in the circle. You can sometimes help guide the results. For instance, before deleting a path that divides a circle, first move it so that the fill you want to keep is larger than the fill you want to remove.

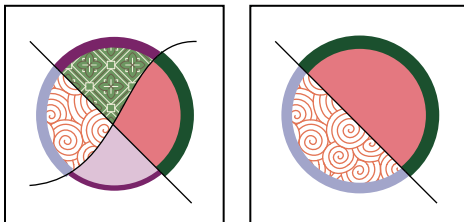

Live Paint group before (left) and after selecting and deleting a path (right)

💡 Save the fill and stroke colors used in Live Paint groups in the Swatches panel. That way, if a change loses a color you want to keep, you can select its swatch and use the Live Paint Bucket tool to reapply the fill or stroke.

More Help topics

[“Isolate artwork for editing”](#) on page 202

Add paths to a Live Paint group

As you add more paths to the Live Paint group, you can fill and stroke the new faces and edges that are created.

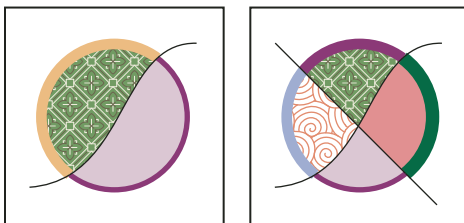

Live Paint group before (left) and after adding a new path and painting the new faces and edges created by it (right)

❖ Do any of the following:

- Using the Selection tool, double-click a Live Paint group (or click the Isolate Selected Group button in the Control panel) to put the group into isolation mode. Then draw another path. Illustrator adds the new path to the Live Paint group. Click the Exit Isolation Mode button  when you're done adding new paths.
- Select a Live Paint group and the paths you want to add to it. Then choose Object > Live Paint > Merge, or click Merge Live Paint in the Control panel.
- In the Layers panel, drag one or more paths into a Live Paint group.

Note: Paths inside a Live Paint group may not exactly align with similar or identical paths outside the Live Paint group.

Resize an individual object or path

❖ Do one of the following:

- Using the Direct Selection tool, click the path or object to select it. Then choose the Selection tool and click the path or object again to edit it.
- Using the Selection tool, double-click the Live Paint Group to put it into isolation mode. Then click a path or object to edit it.

Paint with the Live Paint Bucket tool

The Live Paint Bucket tool lets you paint faces and edges of Live Paint groups with the current fill and stroke attributes. The tool pointer displays as either one or three color squares, which represent the selected fill or stroke color and, if you're using colors from a swatch library, the two colors adjacent to the selected color in the library. You can access the adjacent colors, as well as the colors next to those, and so on, by pressing the left or right arrow key.

- 1 Select the Live Paint Bucket tool .
- 2 Specify the fill color or stroke color and size you want.

Note: If you select a color from a the Swatches panel, the pointer changes to display three colors . The selected color is in the middle, and the two adjacent colors are on either side. To use an adjacent color, click the left or right arrow key.

- 3 To paint a face, do any of the following:

- Click a face to fill it. (When the pointer is over a face, it changes to a half-filled paint bucket  and highlight lines surround the inside of the fill.)
- Drag across multiple faces to paint more than one face at a time.
- Double-click a face to fill across unstroked edges into adjacent faces (flood fill).
- Triple-click a face to fill all faces that currently have the same fill.

 To switch to the Eyedropper tool and sample fills or strokes, Alt-click (Windows) or Option-click (Mac OS) the fill or stroke you want.

- 4 To paint an edge, double-click the Live Paint Bucket tool and select Paint Strokes, or temporarily toggle to the Paint Strokes option, by pressing Shift; and then do any of the following:

- Click an edge to stroke it. (When the pointer is over an edge, it changes to a paint brush  and the edge is highlighted.)
- Drag across multiple edges to stroke more than one edge at a time.
- Double-click an edge to stroke all connected edges of the same color (flood stroke).
- Triple-click an edge to stroke all edges of the same stroke.

Note: Pressing Shift lets you quickly toggle between painting only strokes and only fills. You can also specify these changes in the Live Paint Bucket Options dialog box. If you currently have both the Paint Fills option and the Paint Strokes option selected, pressing Shift switches to Paint Fills only. (This can be helpful when you are trying to fill a small face surrounded by stroked edges.)

More Help topics

[“Fill and Stroke controls”](#) on page 150

[“Apply a fill color to an object”](#) on page 151

[“Stroke an object”](#) on page 151

Live Paint Bucket options

The Live Paint Bucket options let you specify how the Live Paint Bucket tool works, choosing whether to paint just fills, just strokes, or both, as well as how to highlight faces and edges as you move the tool over them. You can see these options by double-clicking the Live Paint Bucket tool.

Paint Fills Paints the faces of Live Paint groups.

Paint Strokes Paints the edges of Live Paint groups.

Cursor Swatch Preview Displays when you choose a color from the Swatches panel. The Live Paint Bucket tool pointer appears as three color swatches: the selected fill or stroke color plus the color directly to the left and right of it in the Swatches panel.

Highlight Outlines the face or edge the cursor is currently over. Faces are highlighted with a thick line and edges are highlighted with a thin line.

Color Sets the color for the highlight. You can choose a color from the menu or click the paint swatch to specify a custom color.

Width Specifies how thick to make the highlight.

Close gaps in Live Paint groups

Gaps are small spaces between paths. If paint leaks through and paints faces you did not intend, you probably have a gap in your artwork. You can create a new path that closes the gap, edit existing paths to close the gap, or adjust the gap options in the Live Paint group.



You can avoid gaps in your Live Paint artwork by overdrawing paths (that is, extending them past each other). You can then select and delete the excess edges that result, or apply a stroke of “None” to them.

Highlight gaps in a Live Paint group

❖ Choose View > Show Live Paint Gaps.

This command highlights any gaps found on the currently selected Live Paint group, based on your gap options settings for that group.

Set Live Paint gap options

❖ Choose Object > Live Paint > Gap Options and specify any of the following:

Gap Detection When selected, Illustrator recognizes gaps in Live Paint paths and prevents paint from flowing through them. Note that this may slow Illustrator when working on large, complex Live Paint groups. In this case, you can choose Close Gaps With Paths to help speed Illustrator up again.

Paint Stops At Sets the size of the gap paint can't flow through.

Custom Specifies a custom Paint Stops At gap size.

Gap Preview Color Sets the color for previewing gaps in Live Paint groups. You can choose a color from the menu, or click the color well next to the Gap Preview Color menu to specify a custom color.

Close Gaps With Paths When selected, inserts unpainted paths into your Live Paint group to close gaps (rather than simply preventing paint from flowing through the gaps). Note that since these paths are unpainted, it may appear gaps are still there even though they have been closed.

Preview Displays currently detected gaps in Live Paint groups as colored lines, based on the preview color you chose.

Gap rules for merged Live Paint groups

When you merge Live Paint groups that have different gap settings, Illustrator uses the following rules to handle the gaps:

- If gap detection is off in all groups in the selection, gaps are closed and gap detection is turned on with Paint Stops At set to Small Gaps.
- If gap detection is on and the same for all groups in the selection, gaps are closed and the gap setting is preserved.
- If gap detection is mixed for the selection, gaps are closed and the gap settings of the bottommost Live Paint group are preserved (if gap detection is on for that group). If the bottommost group has gap detection turned off, gap detection is turned on and Paint Stops At is set to Small Gaps.

Brushes

About brushes

Brushes let you stylize the appearance of paths. You can apply brush strokes to existing paths, or you can use the Paintbrush tool to draw a path and apply a brush stroke simultaneously.

There are different types of brushes in Illustrator: calligraphic, scatter, art, pattern, and bristle. You can achieve the following effects using these brushes:

Calligraphic brushes Create strokes that resemble those drawn with the angled point of a calligraphic pen and are drawn along the center of the path. When you use the Blob Brush tool, you can paint with a calligraphic brush and automatically expand the brush stroke into a fill shape that merges with other filled objects of the same color that intersect or are adjacent in stacking order.

Scatter brushes Disperse copies of an object (such as a ladybug or a leaf) along the path.

Art brushes Stretch a brush shape (such as Rough Charcoal) or object shape evenly along the length of the path.

Bristle brush Create brush strokes with the appearance of a natural brush with bristles.

Pattern brushes Paint a pattern—made of individual *tiles*—that repeats along the path. Pattern brushes can include up to five tiles, for the sides, inner corner, outer corner, beginning, and end of the pattern.

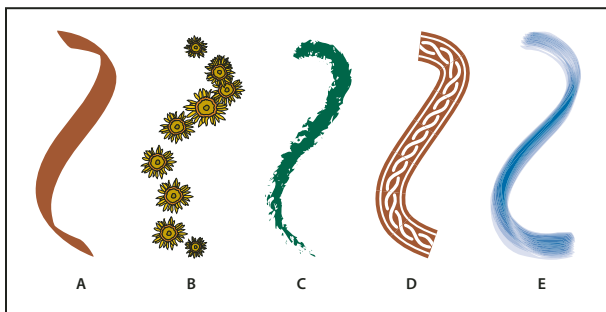

A. Calligraphic Brush B. Scatter Brush C. Art Brush D. Pattern Brush E. Bristle Brush

Scatter brushes and Pattern brushes can often achieve the same effect. However, one way in which they differ is that Pattern brushes follow the path exactly, while Scatter brushes do not.

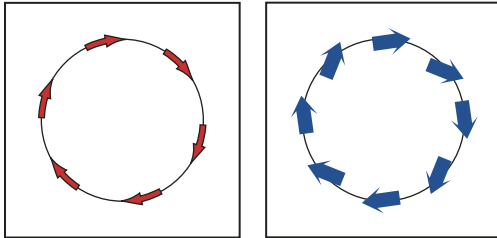

Arrows in a Pattern brush bend to follow the path (left), but arrows remain straight in a Scatter brush (right).

For a video on using brushes, see www.adobe.com/go/vid0044.

More Help topics

“[Draw and merge paths with the Blob Brush tool](#)” on page 155

Brushes panel overview

The Brushes panel (Window > Brushes) displays brushes for the current file. Whenever you select a brush in a brush library, it is automatically added to the Brushes panel. Brushes that you create and store in the Brushes panel are associated only with the current file, which means that each Illustrator file can have a different set of brushes in its Brushes panel.

More Help topics

“[Keys for the Brushes panel](#)” on page 483

Show or hide a type of brush

- ❖ Choose any of the following from the panel menu: Show Calligraphic Brushes, Show Scatter Brushes, Show Art Brushes, Show Bristle Brushes, Show Pattern Brushes.

Change the view of brushes

- ❖ Choose Thumbnail View or List View from the panel menu.

Change the order of brushes in the Brushes panel

- ❖ Drag a brush to a new location. You can move brushes only within their type. For example, you cannot move a Calligraphic brush to the Scatter brush area.

Duplicate a brush in the Brushes panel

- ❖ Drag the brush onto the New Brush button  or choose Duplicate Brush from the Brushes panel menu.

Delete the brushes from the Brushes panel

- ❖ Select the brushes and click the Delete Brush button . You can select brushes that aren't used in a document by choosing Select All Unused from the Brushes panel menu.

Work with brush libraries

Brush libraries (Window > Brush Libraries > [library]) are collections of preset brushes that come with Illustrator. You can open multiple brush libraries to browse through their contents and select brushes. You can also open brush libraries using the Brushes panel menu.



To automatically open a brush library when you start Illustrator, choose Persistent from the brush library's panel menu.

Copy brushes from a brush library to the Brushes panel

❖ Drag the brushes to the Brushes panel or choose Add To Brushes from the brush library's panel menu.

Import brushes into the Brushes panel from another file

- 1 Choose Window > Brushes Libraries > Other Library and select the file.
- 2 In the Brush Library panel, click on the individual brush definition or all the brush definitions that you need to import and select Add To Brushes from the Brush Library panel menu (flyout menu).

Create new brush libraries

- 1 Add the brushes you want to the Brushes panel, and delete any brushes you don't want.
- 2 Choose Save Brush Library from the Brushes panel menu, and place the new library file in one of the following folders so that it will appear in the Brush Libraries menu when you restart Illustrator:
 - (Windows XP) Documents and Settings/User/Application Data/Adobe/Adobe IllustratorCS5 Settings/Brush
 - (Windows Vista/Windows 7) User/AppData/Roaming/Adobe/Adobe Illustrator CS5 Settings/Brush
 - (Mac OS) Library/Application Support/Adobe/Adobe Illustrator CS5/Brush

Note: *If you place the file in a different folder, you can open the library by choosing Window > Brush Libraries > Other Library and selecting the library file.*

Apply brush strokes

You can apply brush strokes to a path created with any drawing tool, including the Pen tool, Pencil tool, or basic shape tools.

- ❖ Do one of the following:
- Select the path, and then select a brush in a brush library, the Brushes panel, or the Control panel.
 - Drag a brush onto the path. If the path already has brush strokes applied to it, then the new brush replaces the old brush.



If you want to apply a different brush to the path and want to use the brush stroke settings used with the original brush, hold down Alt (Win) or Option (Mac OS) when clicking the new brush you want to apply.

Draw paths and apply brush strokes simultaneously

- 1 Select a brush in a brush library or the Brushes panel.
- 2 Select the Paintbrush tool .
- 3 Position the pointer where you want the brush stroke to begin, and drag to draw a path. A dotted line follows the pointer as you drag.

4 Do one of the following:

- To draw an open path, release the mouse button when the path is the desired shape.
- To draw a closed shape, hold down Alt (Windows) or Option (Mac OS) as you drag. The Paintbrush tool displays a small loop . Release the mouse button (but not the Alt or Option key) when you are ready to close the shape.

Illustrator sets down anchor points as you draw. The number of anchor points is determined by the length and complexity of the path and by the Paintbrush tolerance settings.

 *To adjust the shape of a brushed path after you finish drawing it, first select the path. Then position the Paintbrush tool on the path, and drag until the path is the desired shape. You can use the technique to extend a brushed path as well as change the shape of the path between the existing end points.*

Paintbrush tool options

Double-click the Paintbrush tool to set the following options:

Fidelity Controls how far you have to move your mouse or stylus before Illustrator adds a new anchor point to the path. For example, a Fidelity value of 2.5 means that tool movements of less than 2.5 pixels aren't registered. Fidelity can range from 0.5 to 20 pixels; the higher the value, the smoother and less complex the path.

Smoothness Controls the amount of smoothing that Illustrator applies when you use the tool. Smoothness can range from 0% to 100%; the higher the percentage, the smoother the path.

Fill New Brush Strokes Applies a fill to the path. This option is most useful when drawing closed paths.

Keep Selected Determines whether Illustrator keeps the path selected after you draw it.

Edit Selected Paths Determines whether you can change an existing path with the Paintbrush tool.

Within: _ pixels Determines how close your mouse or stylus must be to an existing path to edit the path with the Paintbrush tool. This option is only available when the Edit Selected Paths option is selected.

Remove brush strokes

- 1 Select a brushed path.
- 2 In the Brushes panel, choose Remove Brush Stroke from the panel menu or click the Remove Brush Stroke button .
- 3 In CS5, you can also remove a brush stroke by selecting the Basic brush from the Brushes panel or Control panel.

Convert brush strokes to outlines

You can convert brush strokes into outlined paths to edit the individual components of a brushed path.

- 1 Select a brushed path.
- 2 Choose Object > Expand Appearance.

Illustrator places the components of the expanded path in a group. Within the group are a path and a subgroup containing the brush stroke outlines.

Create or modify brushes

You can create and customize calligraphic, scatter, art, pattern, and bristle brushes depending on your requirement. For scatter, art, and pattern brushes, you must first create the artwork.

Follow these guidelines when creating artwork for brushes:

- The artwork cannot contain gradients, blends, other brush strokes, mesh objects, bitmap images, graphs, placed files, or masks.
- For art and pattern brushes, the artwork cannot contain type. To achieve a brush-stroke effect with type, create an outline of the type and then create a brush with the outline.
- For pattern brushes, create up to five pattern tiles (depending on the brush configuration), and add the tiles to the Swatches panel.

Note: You can make the brushes you create available for every new document by adding the brush definition to the New Document Profile. For more information on new document profiles, see “[About new document profiles](#)” on page 25

More Help topics

“[About patterns](#)” on page 195

“[Create corner tiles for brush patterns](#)” on page 199

Create a brush

- 1 For scatter and art brushes, select the artwork you want to use. For pattern brushes, you can select the artwork for the side tile, but it isn't necessary. For detailed guidelines to create pattern brushes, see “[Guidelines for constructing pattern tiles](#)” on page 195. To know more about pattern brush options, see “[Pattern brush options](#)” on page 176.

Note: If you do not want to see a seam between the artwork pieces used to create the pattern brush, turn off the Anti-Aliasing option from *Edit > Preferences > General (Windows)* or *Illustrator > General > Preferences (Mac OS)*.

- 2 Click the New Brush button  in the Brushes panel. Alternatively, drag the selected artwork to the Brushes panel.
- 3 Select the type of brush you want to create, and click OK.
- 4 In the Brush Options dialog box, enter a name for the brush, set brush options, and click OK.

Modify a brush

- To change the options for a brush, double-click the brush in the Brushes panel. Set the brush options and click OK. If the current document contains brushed paths that use the modified brush, a message appears. Click Apply To Strokes to change pre-existing strokes. Click Leave Strokes to leave pre-existing strokes unchanged, and apply the modified brush to new strokes only.
- To change the artwork used by a scatter, art, or pattern brush, drag the brush into your artwork and make the changes you want. Then Alt-drag (Windows) or Option-drag (Mac OS) the modified brush onto the original brush in the Brushes panel.
- To modify a brushed path without updating the corresponding brush, select the path and click the Options Of Selected Object button  in the Brushes panel or select options of selected object from the Brushes panel menu (flyout menu).

Brush options

You can specify different options for the different types of brushes. To change the options for a brush, double-click the brush in the Brushes panel.

Scatter, Art, and Pattern brushes all have identical options for colorization.

To customize a stroke instance for Art Brushes or Pattern Brushes, click the Options of Selected Objects icon in the Brushes Panel and set the stroke options. For art brush you can set the stroke width along with flipping, colorization, and overlapping options. For pattern brush, you can set the scaling options along with flipping, fitting, and colorization options.

Calligraphic brush options

Angle Determines the angle of rotation for the brush. Drag the arrowhead in the preview, or enter a value in the Angle box.

Roundness Determines roundness of the brush. Drag a black dot in the preview away from or toward the center, or enter a value in the Roundness box. The higher the value, the greater the roundness.

Diameter Determines the diameter of the brush. Use the Diameter slider, or enter a value in the Diameter box.

The pop-up list to the right of each option lets you control variations in the shape of the brush. Select one of the following options:

- **Fixed** Creates a brush with a fixed angle, roundness, or diameter.
- **Random** Creates a brush with random variations in angle, roundness, or diameter. Enter a value in the Variation box to specify the range within which the brush characteristic can vary. For example, when the Diameter value is 15 and the Variation value is 5, the diameter can be 10, or 20, or any value in between.
- **Pressure** Creates a brush that varies in angle, roundness, or diameter based on the pressure of a drawing stylus. This option is most useful when used with Diameter. It is available only if you have a graphics tablet. Enter a value in the Variation box to specify how much more or less than the original value the brush characteristic will vary. For example, when the Roundness value is 75% and the Variation value is 25%, the lightest stroke is 50% and the heaviest stroke is 100%. The lighter the pressure, the more angular the brush stroke.
- **Stylus Wheel** Creates a brush that varies in diameter based on manipulation of the stylus wheel. This option is intended to be used with an airbrush pen that has a stylus wheel on its barrel and with a graphics tablet that can detect that pen.
- **Tilt** Creates a brush that varies in angle, roundness, or diameter based on the tilt of a drawing stylus. This option is most useful when used with Roundness. It is available only if you have a graphics tablet that can detect how close to vertical the pen is.
- **Bearing** Creates a brush that varies in angle, roundness, or diameter based on the bearing of the pen. This option is most useful when used to control the angle of calligraphic brushes, especially when you're using the brush like a paintbrush. It is available only if you have a graphics tablet that can detect the direction in which the pen is tilted.
- **Rotation** Creates a brush that varies in angle, roundness, or diameter based on how the drawing stylus pen tip is rotated. This option is most useful when used to control the angle of calligraphic brushes, especially when you're using the brush like a flat pen. It is available only if you have a graphics tablet that can detect this type of rotation.

Colorization options for scatter, art, and pattern brushes

The colors that a scatter, art, or pattern brush paints depend on the current stroke color and the colorization method of the brush. To set the colorization method, select one of the following options in the Brush Options dialog box:

None Displays colors as they appear in the brush in the Brushes panel. Choose None to keep a brush the same colors as in the Brushes panel.

Tints Displays the brush stroke in tints of the stroke color. Portions of the art that are black become the stroke color, portions that aren't black become tints of the stroke color, and white remains white. If you use a spot color as the stroke, Tints generates tints of the spot color. Choose Tints for brushes that are in black and white, or when you want to paint a brush stroke with a spot color.

Tints And Shades Displays the brush stroke in tints and shades of the stroke color. Tints and Shades maintains black and white, and everything between becomes a blend from black to white through the stroke color. Because black is added you may not be able to print to a single plate when using Tints and Shades with a spot color. Choose Tints and Shades for brushes that are in grayscale.

Hue Shift Uses the key color in the brush artwork, as shown in the Key Color box. (By default, the key color is the most prominent color in the art.) Everything in the brush artwork that is the key color becomes the stroke color. Other colors in the brush artwork become colors related to the stroke color. Hue Shift maintains black, white, and gray. Choose Hue Shift for brushes that use multiple colors. To change the key color, click the Key Color eyedropper, move the eyedropper to the preview in the dialog box, and click the color you want to use as the key color. The color in the Key Color box changes. Click the eyedropper again to deselect it.

For information and samples about each choice, click Tips.

Scatter brush options

Size Controls the size of the objects.

Spacing Controls the amount of space between objects.

Scatter Controls how closely objects follow the path independently on each side of the path. The higher the value, the farther the objects are from the path.

Rotation Controls the angle of rotation of the objects.

Rotation Relative To Sets the angle of rotation for scattered objects relative to the page or the path. For example, if you select Page, at 0° of rotation, objects point to the top of the page. If you select Path, at 0° of rotation, objects are tangent to the path.

The pop-up list to the right of each option lets you control variations in the shape of the brush. Select one of the following options:





- **Fixed** Creates a brush with a fixed size, spacing, scattering, and rotation.
- **Random** Creates a brush with random variations in size, spacing, scattering, and rotation. Enter a value in the Variation box to specify the range within which the brush characteristic can vary. For example, when the Diameter value is 15 and the Variation value is 5, the diameter can be 10, or 20, or any value in between.
- **Pressure** Creates a brush that varies in angle, roundness, or diameter based on the pressure of a drawing stylus. This option is available only if you have a graphics tablet. Enter a value in the rightmost box, or use the Maximum slider. Pressure uses the Minimum value for the lightest tablet pressure and the Maximum value for the heaviest pressure. When you choose this setting for Diameter, the heavier the stroke, the larger the objects.
- **Stylus Wheel** Creates a brush that varies in diameter based on manipulation of the stylus wheel. This option is available only if you have a graphics tablet that has a stylus wheel on its barrel and can detect input from that pen.
- **Tilt** Creates a brush that varies in angle, roundness, or diameter based on the tilt of a drawing stylus. It is available only if you have a graphics tablet that can detect how close to vertical the pen is.
- **Bearing** Creates a brush that varies in angle, roundness, or diameter based on the bearing of a drawing stylus. This option is most useful when used to control the angle of brushes. It is available only if you have a graphics tablet that can detect the direction in which the pen is tilted.
- **Rotation** Creates a brush that varies in angle, roundness, or diameter based on how the drawing stylus pen tip is rotated. This option is most useful when used to control the angle of brushes. It is available only if you have a graphics tablet that can detect this type of rotation.

Art brush options

Width Adjusts the width of the art relative to its original width. You can specify the width using the Width option slider. The art brush Width pop-up menu has pen tablet options for adjusting scale variation, such as Pressure, Stylus Wheel, Tilt, Bearing, and Rotation. The default art brush width is 100%.

Note: If you use the Width tool on a particular Art brush stroke instance, all the tablet data is converted to Width points. Notice that in the Width drop-down list settings, the Width Points/Profiles option is selected.

Brush Scale Options Preserves proportions in scaled art. The options available are: Scale Proportionately, Stretch to Fit Stroke Length, Stretch Between Guides.

Direction Determines the direction of the artwork in relation to the line. Click an arrow to set the direction:  to place the left side of the art is the end of the stroke;  to place the right side of the art is the end of the stroke;  to place the top of the art is the end of the stroke;  to place the bottom of the art is the end of the stroke.

Flip Along or Flip Across Change the orientation of the art in relation to the line.

Colorization Pick a color for the stroke and method of colorization. You can select from different colorization methods using this drop-down list. The options are Tints, Tints and Shades, and Hue Shift.

Overlap To avoid joins and folds of an object's edges to overlap, you can select the Overlap adjustment button .

For a video on using the enhanced features of art brushes, see www.adobe.com/go/lrvid5214_ai_en.

Segmented art brush

Segmented art brush is an ability to define a non-stretchable portion at the ends of an art brush. From the Art brush's Brush Options dialog box, select the Stretch Between Guides option, and adjust the guides in the preview section of the dialog box.



Stretch Between Guides option in the Art brush's Brush Options dialog box

The art enclosed between the guides is the only portion of the brush that stretches or contracts to make the art brush fit the path length.

Segmented Art Brush



Non-segmented Art Brush



Comparing between segmented art brush and non-segmented art brush

Pattern brush options

Scale Adjusts the size of tiles relative to their original size. Specify the scale using the Scale option slider. The Scale drop-down list for pattern brush tool include pen tablet options for adjusting scale variations, such as Pressure, Stylus Wheel, Tilt, Bearing, and Rotation.

Note: If you use the Width tool on a particular Pattern brush stroke instance, all the tablet data is converted to Width points. Notice that in the Scale pop-up menu for stroke options, the Width Points/Profiles option is selected.

Spacing Adjusts the space between tiles.

Tile buttons Let you apply different patterns to different parts of the path. Click a tile button for the tile you want to define, and select a pattern swatch from the scroll list. Repeat to apply pattern swatches to other tiles as needed.

Note: You must add the pattern tiles you want to use to the Swatches panel before you set pattern brush options. After you create a pattern brush, you can delete the pattern tiles from the Swatches panel if you don't plan to use them for additional artwork.

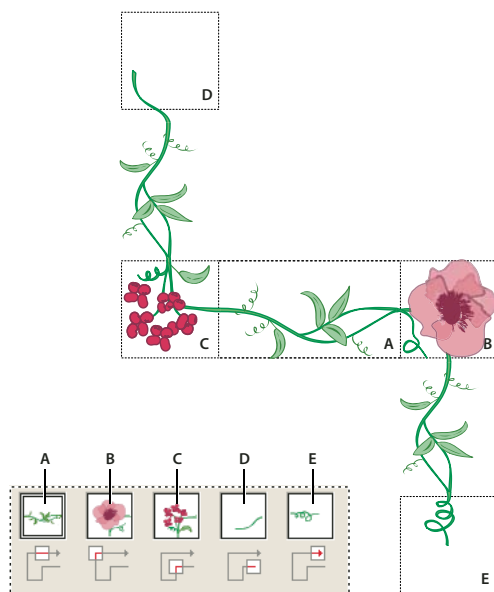

Tiles in a pattern brush

A. Side tile B. Outer Corner tile C. Inner Corner tile D. Start tile E. End tile

Flip Along or Flip Across Changes the orientation of the pattern in relation to the line.

Fit Determines how the pattern fits on the path: Stretch To Fit lengthens or shortens the pattern tile to fit the object. This option can result in uneven tiling. Add Space To Fit adds blank space between each pattern tile to apply the pattern proportionally to the path. Approximate Path fits tiles to the closest approximate path without changing the tiles. This option applies the pattern slightly inside or outside the path, rather than centered on the path, to maintain even tiling.

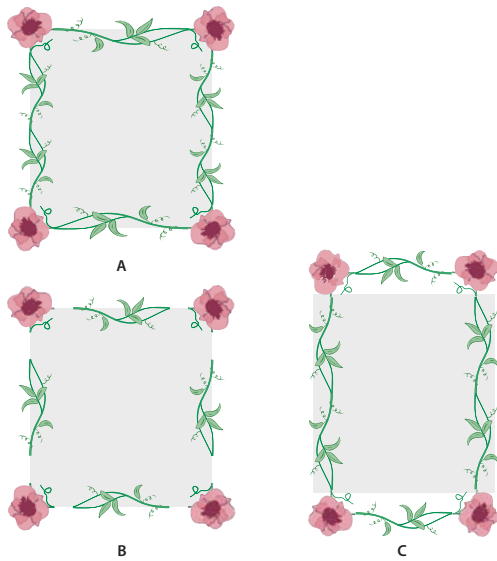

Fit options
A. Stretch To Fit B. Add Space To Fit C. Approximate Path

Colorization Pick a color for the stroke and method of colorization. You can select from different colorization methods using this drop-down list. The options are Tints, Tints and Shades, and Hue Shift.

For a video on using the enhanced features of art brushes, see www.adobe.com/go/lrvid5214_ai_en.

Bristle brush

Bristle brush allows you to create brush strokes with the appearance of a natural brush with bristles. With Bristle brush, you can:

- Create natural and fluid brush strokes that simulate the effects of painting with real brushes and media such as water color.
- Select brushes from a predefined library or create your own brushes from the provided tip shapes such as round, flat, or fan. You can also set other brush characteristics such as bristle length, stiffness, and paint opacity.



An illustration that uses different Bristle brush shapes and characteristics for drawing

When you use Bristle brush with a graphic tablet, Illustrator interactively tracks the movements of the stylus over the tablet. It interprets all aspects of its orientation and pressure input at any point along a drawing path. Illustrator provides the output that is modeled on the stylus's x-axis position, y-axis position, pressure, tilt, bearing, and rotation.

A cursor annotator that simulates the tip of an actual brush is displayed when using a tablet and stylus that support rotation. This annotator does not appear when other input devices such as a mouse are used. The annotator is also disabled while using the precise cursors.

Note: Use the Wacom Intuos 3 or higher tablet with Art (6D) pen to explore the full capabilities of the Bristle brush. Illustrator can interpret all 6-degrees of freedom that this device combination provides. However, other devices including the Wacom Grip pen and Art brush pen may not be able to interpret some attributes such as rotation. These uninterpreted attributes are treated as constants in the resulting brush strokes.

While using a mouse, only x and y-axis movements are recorded. Other inputs, such as tilt, bearing, rotation, and pressure remain fixed resulting in even and consistent strokes.

For Bristle brush strokes, feedback is displayed when you drag the tool. This feedback provides an approximate view of the final stroke.

Note: Bristle brush strokes are made up of several overlapping, filled transparent paths. These paths, like any other filled path in Illustrator, interact with the paint of other objects, including other bristle brush paths. However, the fill for strokes does not self-interact. Therefore, layered, individual, bristle brush strokes build up and interact with each other, but a single stroke scrubbed back and forth in place does not interact with itself and build up.

Using the Bristle brush

To use the Bristle brush do the following:

- 1 Create a brush definition by clicking the new brush icon or selecting New Brush from the Brushes panel menu.
- 2 Select the Bristle Brush option and click OK.

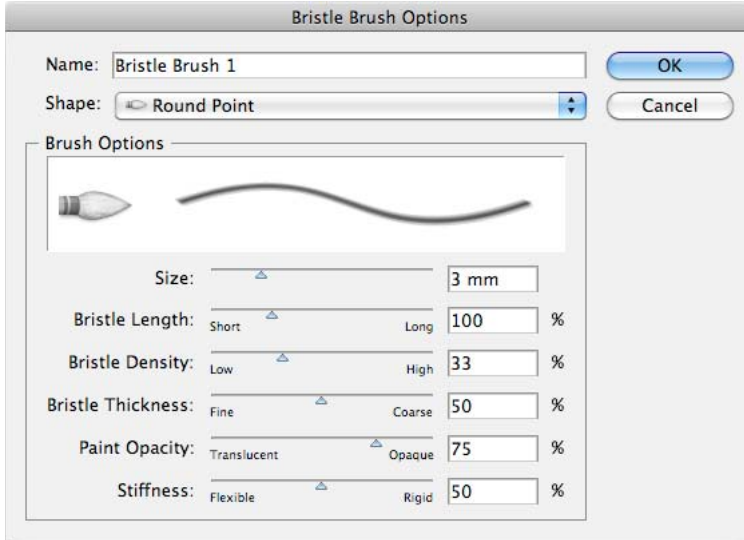

Bristle Brush Options dialog box

- 3 In the Bristle Brush Options dialog box, specify:

Name of the bristle brush. Maximum length of the brush name can be 31 characters.

Shape Select from ten different brush models, which provide a different drawing experience and appearance of bristle brush paths.

Size Brush size is the diameter of the brush. Like a physical media brush, the Bristle brush diameter is measured at the point where the bristles meet the handle (the ferrule). Specify the brush size using the slider or directly entering the size in the available text field. Range can be between 1mm and 10mm.

Brush size from the original Brush definition is displayed in Brush preview in the Brushes panel.

Note: The bracket keys, [and], are used as shortcuts for decreasing and increasing the size, respectively. The bracket keys increase and decrease the size in 1mm increments.

Bristle Length The bristle length starts from the point where the bristles meet the handle of the bristle tip. The length of the bristles can be specified in the same way as other bristle brush options, by dragging the Bristle Length slider, or specifying the exact value in the Bristle Length field (25% to 300%).

Bristle Density The bristle density is the number of bristles in a specified area of the brush neck. You can set this attribute in the same way as other bristle brush options. It ranges between 1% and 100%, and is calculated based on the brush size and bristle length.

Bristle Thickness The bristle thickness can vary from fine to coarse (between 1% and 100%). Set the bristle thickness like other bristle brush settings, by dragging the slider, or specifying the thickness value in the field.

Paint Opacity This option lets you set the opacity of the paint being used. The paint opacity can vary between 1% (Translucent) and 100% (opaque). The specified opacity value is the maximum opacity used in the brush. You can use the numeric keys[0-9] as shortcut to set the opacity of bristle brush strokes where:

- 0 = 100
- 1 = 10%
- 9 = 90

In other cases, for example, if you enter 35 in succession, the opacity is set to 35%, and if you enter 356 in succession the opacity value is set to 56 (last two digits). Any string of digits that ends with 00 are set as 100%.

Stiffness Stiffness implies the rigidness of the bristles. If you set a low bristle stiffness value, the bristles are flexible. They become more rigid when you set a higher value. The bristle stiffness ranges between 1% and 100%.

4 Click OK to create the brush definition with the chosen settings.

With the brush tool selected, and a Bristle brush definition chosen in the Brushes panel, you can create artwork using the Bristle brush.

If you try to print, save, or flatten transparency in a document with more than 30 bristle brush strokes, a warning message is displayed. These warnings are displayed when you save, print, and flatten file content.

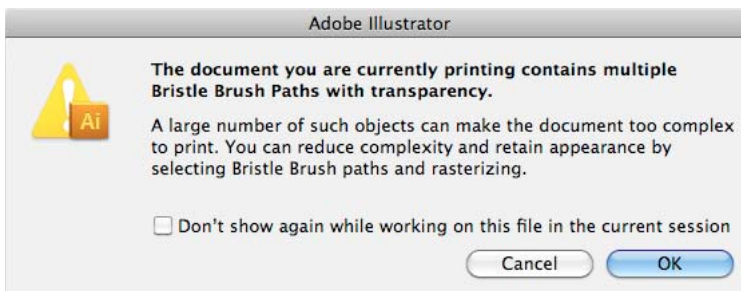

Warning dialog box when trying to print a document with more than 30 bristle brush strokes

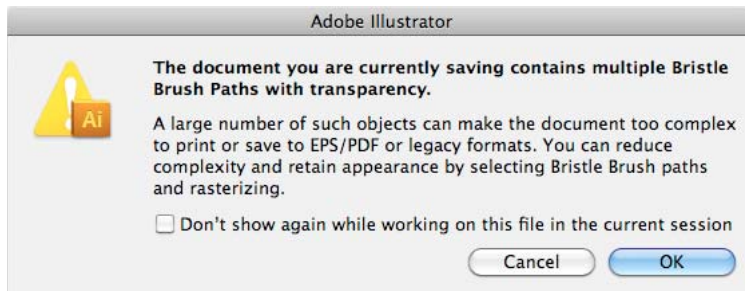

Warning dialog box when trying to save a document with more than 30 bristle brush strokes

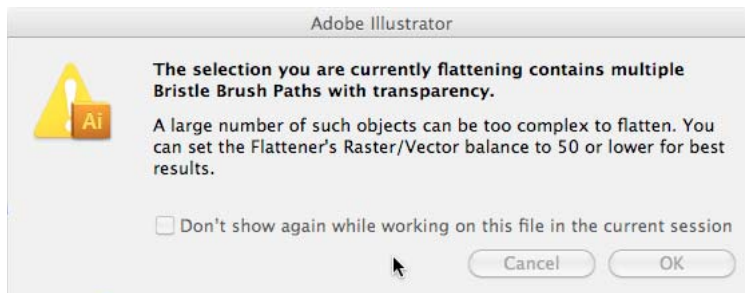

Warning dialog box when trying to flatten the transparency of bristle brush strokes in a document with more than 30 bristle brush strokes

Transparency and blending modes

About transparency

Transparency is such an integral part of Illustrator that it's possible to add transparency to your artwork without realizing it. You can add transparency to artwork by doing any of the following:

- Lowering the opacity of objects so that underlying artwork becomes visible.
- Using opacity masks to create variations in transparency.
- Using a blending mode to change how colors interact among overlapping objects.
- Applying gradients and meshes that include transparency.
- Applying effects or graphic styles that include transparency, such as drop shadows.
- Importing Adobe Photoshop files that include transparency.

For a video on working with transparency, see www.adobe.com/go/vid0054.

For more information on working with transparency across Adobe Creative Suite, see www.adobe.com/go/learn_ai_transparency_pdf_en.

More Help topics

[Transparency tutorial](#)

[“Printing and saving transparent artwork”](#) on page 431

[“About blending modes”](#) on page 186

Transparency panel overview

You use the Transparency panel (Window > Transparency) to specify the opacity and blending mode of objects, to create opacity masks, or to knock out a portion of one object with the overlying portion of a transparent object.

More Help topics

“[Workspace overview](#)” on page 5

Show all options in the Transparency panel

- ❖ Choose Show Options from the panel menu.

Show a thumbnail of the selected object in the Transparency panel

- ❖ Choose Show Thumbnail from the panel menu. Or, click the double triangle on the panel’s tab to cycle through the display sizes.

View transparency in artwork

It’s important to be aware of when you’re using transparency, because you need to set some extra options when printing and saving transparent artwork. To view transparency in your artwork, display a checkered background grid to identify transparent areas of your artwork.

- 1 Choose View > Show Transparency Grid.
- 2 (Optional) Choose File > Document Setup, and set transparency grid options.

Note: You can also change the artboard color to simulate what your artwork will look like if printed on colored paper.

Change the opacity of artwork

You can change the opacity of a single object, the opacity of all objects in a group or layer, or the opacity of an object’s fill or stroke.

- 1 Select an object or group (or target a layer in the Layers panel).

If you want to change the opacity of a fill or stroke, select the object, and then select the fill or stroke in the Appearance panel.

- 2 Set the Opacity option in the Transparency panel or Control panel.



To select all objects that use a specific opacity, select an object with that opacity, or deselect everything and enter the opacity value in the Transparency panel. Then choose Select > Same > Opacity.

If you select multiple objects in a layer and change the opacity setting, the transparency of overlapping areas of the selected objects will change relative to the other objects and show an accumulated opacity. In contrast, if you target a layer or group and then change the opacity, the objects in the layer or group are treated as a single object. Only objects *outside* and below the layer or group are visible through the transparent objects. If an object is moved into the layer or group, it takes on the layer’s or group’s opacity, and if an object is moved outside, it doesn’t retain the opacity.

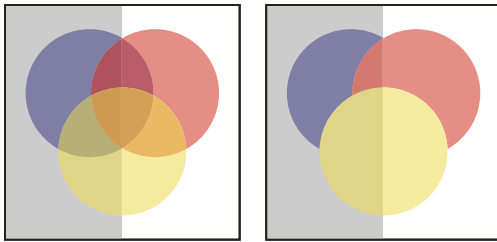

Individual objects selected and set to 50% opacity (left) compared to layer targeted and set to 50% opacity (right)

More Help topics

[“Targeting items for appearance attributes”](#) on page 363

[“Appearance panel overview”](#) on page 362

[“Printing and saving transparent artwork”](#) on page 431

Create a transparency knockout group

In a *transparency knockout group*, the elements of a group do not show through each other.

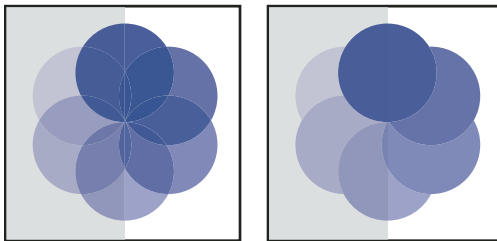

Group with Knockout Group option deselected (left) compared to selected (right)

- 1 In the Layers panel, target the group or layer you want to turn into a knockout group.
- 2 In the Transparency panel, select Knockout Group. If this option isn't visible, select Show Options from the panel menu.

Selecting the Knockout Group option cycles it through three states: on (check mark), off (no mark), and neutral (square with a line through it). Use the neutral option when you want to group artwork without interfering with the knockout behavior determined by the enclosing layer or group. Use the off option when you want to ensure that a layer or a group of transparent objects will never knock each other out.

More Help topics

[“Targeting items for appearance attributes”](#) on page 363

[“Printing and saving transparent artwork”](#) on page 431

Use opacity masks to create transparency

You use an *opacity mask* and a *masking object* to alter the transparency of artwork. The opacity mask (also referred to as masked artwork) provides the shape through which other objects show. The masking object defines which areas are transparent and the degree of transparency. You can use any colored object or raster image as the masking object. Illustrator uses the grayscale equivalents of the colors in the masking object for the opacity levels in the mask. Where the opacity mask is white, the artwork is fully visible. Where the opacity mask is black, the artwork is hidden. Shades of gray in the mask result in varying degrees of transparency in the artwork.

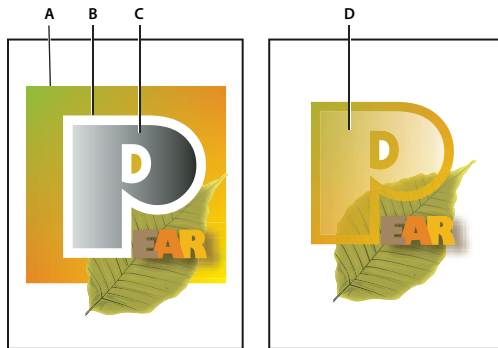

Creating an opacity mask

A. Underlying objects B. Opacity mask artwork C. Masking object filled with black-to-white gradient D. C moved over the area of B and masking B

When you create the opacity mask, a thumbnail of the masking object appears in the Transparency panel to the right of the thumbnail of the masked artwork. (If these thumbnails aren't visible, choose Show Thumbnails from the panel menu.) By default, the masked artwork and the masking object are linked (as shown by a link between the thumbnails in the panel). When you move the masked artwork, the masking object moves along with it. However, when you move a masking object, the masked artwork doesn't move. You can unlink the mask in the Transparency panel to lock the mask in place and move the masked artwork independently of it.

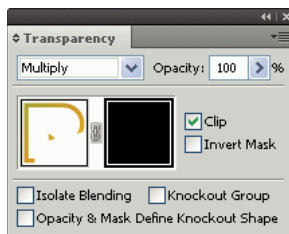

Transparency panel displays opacity mask thumbnails: left thumbnail represents the opacity mask, right thumbnail represents masking objects

You can move masks between Photoshop and Illustrator. Opacity masks in Illustrator convert to layer masks in Photoshop, and vice versa.

Note: *You cannot enter isolation mode when working in mask-editing mode, or vice versa.*

For a video on working with opacity masks, see www.adobe.com/go/vid0056.

More Help topics

[“Printing and saving transparent artwork”](#) on page 431

[“Targeting items for appearance attributes”](#) on page 363

Create an opacity mask

- 1 Select a single object or group, or target a layer in the Layers panel.
- 2 Open the Transparency panel and, if necessary, choose Show Options from the panel menu to see the thumbnail images.
- 3 Double-click directly to the right of the thumbnail in the Transparency panel.

An empty mask is created and Illustrator automatically enters mask-editing mode

- 4 Use the drawing tools to draw a mask shape.

5 Click the masked artwork's thumbnail (left thumbnail) in the Transparency panel to exit mask-editing mode.

Note: The Clip option sets the mask background to black. Therefore, black objects, such as black type, used to create an opacity mask with the Clip option selected will not be visible. To see the objects, use a different color or deselect the Clip option.

Convert an existing object into an opacity mask

- ❖ Select at least two objects or groups, and choose Make Opacity Mask from the Transparency panel menu. The topmost selected object or group is used as the mask.

Edit a masking object

You can edit a masking object to change the shape or transparency of the mask.

- 1 Click the masking object's thumbnail (right thumbnail) in the Transparency panel.
- 2 Alt-click (Windows) or Option-click (Mac OS) the mask thumbnail to hide all other artwork in the document window. (If the thumbnails aren't visible, choose Show Thumbnails from the panel menu.)
- 3 Use any of the Illustrator editing tools and techniques to edit the mask.
- 4 Click the masked artwork's thumbnail (left thumbnail) in the Transparency panel to exit mask-editing mode.

Unlink or relink an opacity mask

- To unlink a mask, target the masked artwork in the Layers panel, and then click the link symbol  between the thumbnails in the Transparency panel. Alternatively, select Unlink Opacity Mask from the Transparency panel menu.

The masking object is locked in position and size, and the masked objects can be moved and resized independently of the mask.

- To relink a mask, target the masked artwork in the Layers panel, and then click the area between the thumbnails in the Transparency panel. Alternatively, select Link Opacity Mask from the Transparency panel menu.

Deactivate or reactivate an opacity mask

You can deactivate a mask to remove the transparency it creates.

- To deactivate a mask, target the masked artwork in the Layers panel, and then Shift-click the masking object's thumbnail (right thumbnail) in the Transparency panel. Alternatively, select Disable Opacity Mask from the Transparency panel menu. When the opacity mask is deactivated, a red x appears over the mask thumbnail in the Transparency panel.
- To reactivate a mask, target the masked artwork in the Layers panel, and then Shift-click the masking object's thumbnail in the Transparency panel. Alternatively, select Enable Opacity Mask from the Transparency panel menu.

Remove an opacity mask

- ❖ Target the masked artwork in the Layers panel, and then select Release Opacity Mask from the Transparency panel menu.

The masking object reappears on top of the objects that were masked.

Clip or invert an opacity mask

- 1 Target the masked artwork in the Layers panel.

2 Select either of the following options in the Transparency panel:

Clip Gives the mask a black background which crops the masked artwork to the boundaries of the masking object. Deselect the Clip option to turn off the clipping behavior. To select clipping for new opacity masks by default, select New Opacity Masks Are Clipping from the Transparency panel menu.

Invert Mask Reverses the luminosity values of the masking object, which reverses the opacity of the masked artwork. For example, areas that are 90% transparent become 10% transparent after the mask is inverted. Deselect the Invert Mask option to return the mask to the original state. To invert all masks by default, select New Opacity Masks Are Inverted from the Transparency panel menu.

If these options aren't visible, select Show Options from the panel menu.

Use transparency to shape a knockout

You can use the Opacity & Mask Define Knockout Shape option to make a knockout effect proportional to the object's opacity. In areas of the mask that are close to 100% opacity, the knockout effect will be strong; in areas with less opacity, the knockout effect will be weaker. For example, if you use a gradient-masked object as a knockout, the underlying object will be knocked out progressively, as if it were being shaded by a gradient. You can create knockout shapes with both vector and raster objects. This technique is most useful for objects that use a blending mode other than Normal.

1 Do one of the following:

- To use an opacity mask to shape the knockout, select the masked artwork, and then group it with the objects you want to knock out.
- To use the alpha channel of a bitmap object to shape the knockout, select a bitmap object that contains transparency, and then group it with the objects you want to knock out.

2 Select the group.

3 In the Transparency panel, select Knockout Group until the option displays a checkmark.

4 Among the grouped objects, target the masking objects or transparent image in the Layers panel.

5 In the Transparency panel, select Opacity & Mask Define Knockout Shape.

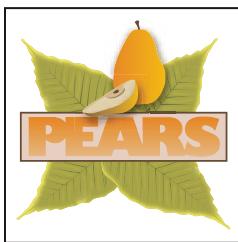

A

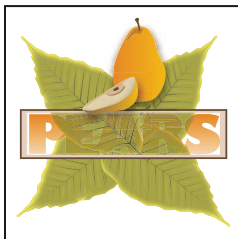

B



C

Knocking out shapes using a bitmap object

A. Original artwork B. Darken blending mode applied to the word "PEARS", and Group option selected C. Opacity & Mask Define Knockout shape option applied to word

More Help topics

“[Printing and saving transparent artwork](#)” on page 431

“[Targeting items for appearance attributes](#)” on page 363

About blending modes

Blending modes let you vary the ways that the colors of objects blend with the colors of underlying objects. When you apply a blending mode to an object, the effect of the blending mode is seen on any objects that lie beneath the object’s layer or group.

It’s helpful to think in terms of the following color terminology when visualizing a blending mode’s effect:

- The *blend color* is the original color of the selected object, group, or layer.
- The *base color* is the underlying color in the artwork.
- The *resulting color* is the color resulting from the blend.

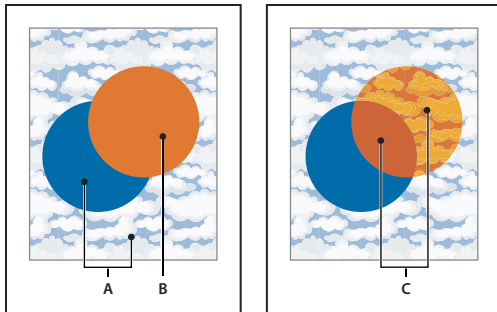

*Topmost object with Normal blending (left) compared to Hard Light blending mode (right)
A. Base colors in underlying objects at 100% opacity B. Blend color in topmost object C. Resulting colors after applying the Hard Light blending mode to the topmost object*

For a video on working with blending modes, see www.adobe.com/go/vid0055. To see an example of how blending modes and gradients can be used to create comic book-inspired characters with depth and color, see www.adobe.com/go/learn_ai_tutorials_blendingmode_en and www.adobe.com/go/learn_ai_tutorials_depth_en.

Illustrator provides the following blending modes:

Normal Paints the selection with the blend color, without interaction with the base color. This is the default mode.

Darken Selects the base or blend color—whichever is darker—as the resulting color. Areas lighter than the blend color are replaced. Areas darker than the blend color do not change.

Multiply Multiplies the base color by the blend color. The resulting color is always a darker color. Multiplying any color with black produces black. Multiplying any color with white leaves the color unchanged. The effect is similar to drawing on the page with multiple magic markers.

Color Burn Darkens the base color to reflect the blend color. Blending with white produces no change.

Lighten Selects the base or blend color—whichever is lighter—as the resulting color. Areas darker than the blend color are replaced. Areas lighter than the blend color do not change.

Screen Multiplies the inverse of the blend and base colors. The resulting color is always a lighter color. Screening with black leaves the color unchanged. Screening with white produces white. The effect is similar to projecting multiple slide images on top of each other.

Color Dodge Brightens the base color to reflect the blend color. Blending with black produces no change.

Overlay Multiplies or screens the colors, depending on the base color. Patterns or colors overlay the existing artwork, preserving the highlights and shadows of the base color while mixing in the blend color to reflect the lightness or darkness of the original color.

Soft Light Darkens or lightens the colors, depending on the blend color. The effect is similar to shining a diffused spotlight on the artwork.

If the blend color (light source) is lighter than 50% gray, the artwork is lightened, as if it were dodged. If the blend color is darker than 50% gray, the artwork is darkened, as if it were burned in. Painting with pure black or white produces a distinctly darker or lighter area but does not result in pure black or white.

Hard Light Multiplies or screens the colors, depending on the blend color. The effect is similar to shining a harsh spotlight on the artwork.

If the blend color (light source) is lighter than 50% gray, the artwork is lightened, as if it were screened. This is useful for adding highlights to artwork. If the blend color is darker than 50% gray, the artwork is darkened, as if it were multiplied. This is useful for adding shadows to artwork. Painting with pure black or white results in pure black or white.

Difference Subtracts either the blend color from the base color or the base color from the blend color, depending on which has the greater brightness value. Blending with white inverts the base-color values. Blending with black produces no change.

Exclusion Creates an effect similar to but lower in contrast than the Difference mode. Blending with white inverts the base-color components. Blending with black produces no change.

Hue Creates a resulting color with the luminance and saturation of the base color and the hue of the blend color.

Saturation Creates a resulting color with the luminance and hue of the base color and the saturation of the blend color. Painting with this mode in an area with no saturation (gray) causes no change.

Color Creates a resulting color with the luminance of the base color and the hue and saturation of the blend color. This preserves the gray levels in the artwork and is useful for coloring monochrome artwork and for tinting color artwork.

Luminosity Creates a resulting color with the hue and saturation of the base color and the luminance of the blend color. This mode creates an inverse effect from that of the Color mode.

***Note:** The Difference, Exclusion, Hue, Saturation, Color, and Luminosity modes do not blend spot colors—and with most blending modes, a black designated as 100% K knocks out the color on the underlying layer. Instead of 100% black, specify a rich black using CMYK values.*

Change the blending mode of artwork

1 Select an object or group (or target a layer in the Layers panel).

If you want to change the blending mode of a fill or stroke, select the object, and then select the fill or stroke in the Appearance panel.

2 In the Transparency panel, choose a blending mode from the pop-up menu.

You can isolate the blending mode to a targeted layer or group in order to leave objects beneath unaffected. To do this, select the target icon to the right of a group or layer in the Layers panel that contains an object using a blending mode. In the Transparency panel, select Isolate Blending. (If the Isolate Blending option isn't visible, select Show Options from the Transparency panel menu.)

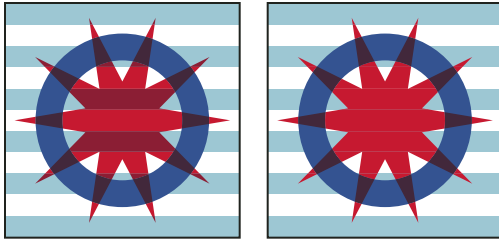

Group (star and circle) with Isolate Blending option deselected (left) compared to selected (right)

 To select all objects that use the same blending mode, select an object with that blending mode, or deselect everything and choose the blending mode in the Transparency panel. Then choose **Select > Same > Blending Mode**.

For a video on working with blending modes, see www.adobe.com/go/vid0055.

More Help topics

“[Targeting items for appearance attributes](#)” on page 363

“[Printing and saving transparent artwork](#)” on page 431

“[Transparency panel overview](#)” on page 181

“[Appearance panel overview](#)” on page 362

Gradients

Use gradient fills to apply a graduated blend of colors as you would apply any other color. Creating a gradient fill is a good way to create a smooth color gradation across one or more objects. You can save a gradient as a swatch to make it easy to apply the gradient to multiple objects.

Note: if you want to create a single, multicolored object on which colors can flow in different directions use a mesh object.

For a video on using gradients to enhance your drawings, see www.adobe.com/go/lrvid4017_ai.

To see examples of using gradients, see www.adobe.com/go/learn_ai_tutorials_gradients_en and www.adobe.com/go/learn_ai_tutorials_elliptical_gradients_en and www.adobe.com/go/learn_ai_tutorials_depth_en.

To see an example of using gradients and blending modes, see the tutorial at www.adobe.com/go/learn_ai_tutorials_blendingmode_en.

More Help topics

[Gradients tutorial](#)

“[Blending objects](#)” on page 250

“[Blend colors](#)” on page 145

“[Meshes](#)” on page 192

“[Printing gradients, meshes, and color blends](#)” on page 428

Gradient panel and Gradient tool overview

You can use the Gradient panel (Window > Gradient) or the Gradient tool to apply, create, and modify gradients.

Gradient colors are defined by a series of stops along the gradient slider. A *stop* marks the point at which a gradient changes from one color to the next, and is identified by a square below the gradient slider. The squares display the color currently assigned to each gradient stop. With a radial gradient, the leftmost gradient stop defines the center point's color fill, which radiates outward to the color of the rightmost gradient stop.

Using the options in the Gradient panel or with the Gradient tool, you can specify the number and location of stops, angle in which the colors display, aspect ratio of an elliptical gradient, and the opacity of each color.

Gradient panel

In the Gradient panel, the Gradient Fill box displays the current gradient colors and gradient type. When you click the Gradient Fill box, the selected object is filled with the gradient. Directly to the right of this box is the Gradient menu that lists all the default and presaved gradients from which you can choose. At the bottom of the list is a Save Gradient button  that you can click to save the current gradient settings as a swatch.

By default, the panel includes a start and end color box, but you can add more color boxes by clicking anywhere along the gradient slider. Double-clicking a gradient stop opens the gradient stop color panel where you can choose a color from the Color panel or Swatches panel.

It's helpful to show all options when working with the panel (choose Show Options from the panel menu).

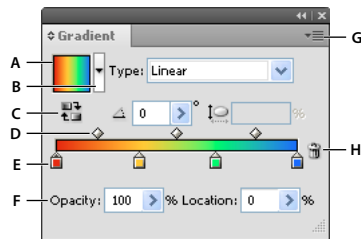

Gradient panel

A. Gradient Fill box B. Gradient menu C. Reverse colors D. Midpoints E. Color stop F. Opacity G Panel menu H. Delete stop

Gradient tool

You use the Gradient tool to add or edit gradients. When you click the Gradient tool in an unselected, nongradient filled object it fills the object with the last used gradient. The Gradient tool also provides most of the same features as the Gradient panel. When you select a gradient filled object and select the Gradient tool, a gradient annotator appears in the object. You can use the gradient annotator to modify the angle, location, and spread of a linear gradient or the focal point, origin, and spread of a radial gradient. If you position the tool directly over the gradient annotator, it becomes a slider (same as in the Gradient panel) with gradient stops and location indicators. You can click the gradient annotator to add new gradient stops, double-click individual gradient stops to specify new colors and opacity settings, or drag gradient stops to new locations.

When you position the pointer over the gradient annotator and the rotation cursor appears  you can drag to reposition the angle of the gradient. Dragging the circular end of the gradient slider repositions the origin of the gradient, and dragging the arrow end increases or decreases the range of the gradient.

To hide or show the gradient annotator, choose View > Hide Gradient Annotator or View > Show Gradient Annotator.

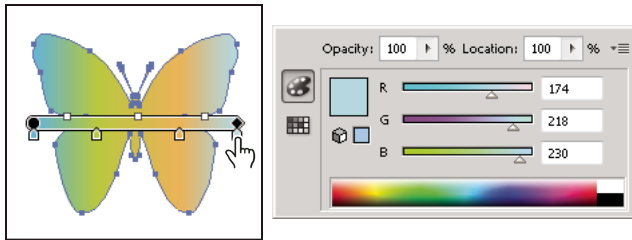



Double-clicking a gradient stop on the gradient annotator in the object opens a color options dialog box for the gradient.



Apply or edit a gradient

After you apply a gradient to an object, you can quickly and easily replace or edit the gradient.

Apply a gradient to an object

❖ Select an object and do one of the following:

- To apply the last used gradient, click the Gradient box  in the Tools panel or the Gradient Fill box in the Gradient panel.
- To apply the last used gradient to an unselected object that currently does not contain a gradient, click the object with the Gradient tool .
- To apply a preset or previously saved gradient, choose a gradient from the Gradient menu in the Gradient panel or click a gradient swatch in the Swatches panel.

 To display only gradients in the Swatches panel, click the Show Swatch Kinds button  and choose Show Gradient Swatches.

Create an elliptical gradient

You can create linear, radial, or elliptical gradients. When you change the aspect ratio for a radial gradient, it becomes an elliptical gradient for which you can also change the angle and make it tilt.

- 1 In the Gradient panel, choose Radial from the Type menu.
- 2 Specify an Aspect Ratio value other than 100%.
- 3 To tilt the ellipse, specify an Angle value other than 0.

Modify the colors in a gradient



1 Do one of the following:

- To modify a gradient without filling an object with it, deselect all objects and double-click the Gradient tool or click the gradient box at the bottom of the Tools panel.
- To modify an object's gradient, select the object, and open the Gradient panel.
- To modify a preset gradient, select a gradient from the Gradient menu in the Gradient panel. Or, click a gradient swatch in the Swatches panel, and then open the Gradient panel.

2 To change the color of a stop, do any of the following:

- Double-click a gradient stop (in either the Gradient panel or the selected object), and specify a new color in the panel that appears. You can change the panel that appears by clicking the Color or Swatches icon along the left. Click outside the panel to accept the selection.
- Drag a color from the Color panel or the Swatches panel onto the gradient stop.

***Note:** If you create a gradient between spot colors, you must deselect *Convert To Process* in the *Separation Setup* dialog box to print the gradient in individual spot color separations.*



- 3 To add intermediate colors to a gradient, drag a color from the Swatches panel or the Color panel onto the gradient slider in the Gradient panel. Or, click anywhere below the gradient slider, and then select a color as you would for the starting or ending color.
- 4 To delete an intermediate color, drag the square off the gradient slider or select it and click the Delete button  in the Gradient panel.
- 5 To adjust the location of colors in the gradient, do any of the following:
 - To adjust the midpoints of the gradient's color stops (the point at which two color stops are 50%), drag a diamond icon located above the slider or select the icon and enter a value from 0 through 100 in the Location box.
 - To adjust the endpoints of the gradient's color stops, drag the leftmost or rightmost gradient stop below the gradient slider.
 - To reverse the colors in the gradient, click Reverse Gradient  in the Gradient panel.
- 6 To change the opacity of a gradient color, click a color stop in the Gradient panel, and specify a value in the Opacity box. When a gradient stop has an Opacity value less than 100%, the stop appears with a , and the color appears checkered in the gradient slider.
- 7 Click the New Swatch button in the Swatches panel to save the new or modified gradient as a swatch. Or, drag the gradient from the Gradient panel or Tools panel to the Swatches panel.

Apply a gradient across multiple objects

- 1 Fill all the objects with a gradient.
- 2 Select all of the objects that you want filled.
- 3 Using the Gradient tool, do one of the following:
 - To create a gradient with one gradient slider, click in the artboard where you want the gradient to start, and drag to where you want the gradient to end.
 - To create a gradient with a gradient slider for every selected object, click in the artboard where you want the gradient to start, and Alt-drag (Windows) or Option-drag (Mac OS) to where you want the gradient to end. You can then adjust the different gradient sliders for the different objects. (Multiple gradient sliders are only created for simple paths.)

Change gradient direction, radius, or origin

Once you have filled an object with a gradient, you can use the Gradient tool and the gradient annotator (slider) inside the object to modify the gradient by drawing a new fill path. This tool lets you change the direction of a gradient, the origin, and the beginning point and endpoint of a gradient.

- 1 Select the gradient-filled object.
- 2 Select the Gradient tool  and do any of the following:
 - To change the direction of a linear gradient, click where you want the gradient to start and drag in the direction you want it to appear. Or, position the Gradient tool on the gradient annotator in the object, and when the cursor changes to the rotation icon , drag to set the angle of the gradient.

***Note:** You can also change the direction by setting a new value in the Angle box in the Gradient panel.*
 - To change the radius of a radial or elliptical gradient, position the Gradient tool on the arrow of gradient annotator in the object and drag to set the radius.

Painting

- To change the origin of the gradient, position the Gradient tool on the beginning of the gradient annotator in the object and drag it to the desired location.
- To change the radius and angle at the same time, Alt-click (Windows) or Option-click (Mac OS) the end point, and drag to the new location.

Note: If the gradient annotator (gradient slider) does not appear when you position the Gradient tool in an object that has a gradient, choose View > Show Gradient Annotator.

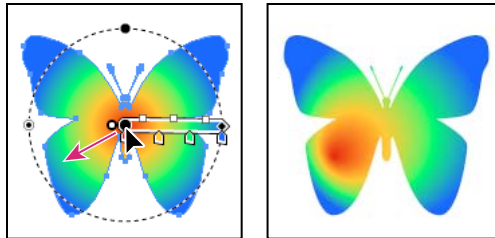

Changing gradient radius and angle at the same time

Meshes

A *mesh object* is a multicolored object on which colors can flow in different directions and transition smoothly from one point to another. When you create a mesh object, multiple lines called *mesh lines* crisscross the object and provide a way to easily manipulate color transitions on the object. By moving and editing points on the mesh lines, you can change the intensity of a color shift, or change the extent of a colored area on the object.

At the intersection of two mesh lines is a special kind of anchor point called a *mesh point*. Mesh points appear as diamonds and have all of the same properties as anchor points but with the added capability of accepting color. You can add and delete mesh points, edit the mesh points, or change the color associated with each mesh point.

Anchor points also appear in the mesh (differentiated by their square rather than diamond shape), and can be added, deleted, edited, and moved as with any anchor points in Illustrator. Anchor points can be placed on any mesh line; you can click an anchor point and drag its direction lines to modify it.

The area between any four mesh points is called the *mesh patch*. You can also change the color of the mesh patch using the same techniques as changing colors on a mesh point.

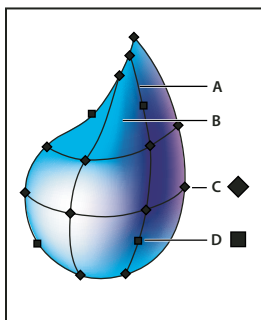

Diagram of a mesh object

A. Mesh line B. Mesh patch C. Mesh point D. Anchor point

Create mesh objects

You can create mesh objects from vector objects, with the exception of compound paths and text objects. You cannot create mesh objects from linked images.

To improve performance and redraw speed, keep the size of mesh objects to a minimum. Complex mesh objects can greatly reduce performance. Therefore, it is better to create a few small, simple mesh objects than to create a single, complex mesh object. When converting complex objects, use the Create Mesh command for the best results.

Note: When printing mesh objects, spot colors are preserved for EPS, PDF, and PostScript output.

For more information on creating a gradient mesh object, see the Achieve photo realism with Gradient Mesh tutorial at www.adobe.com/go/learn_ai_tutorials_gradientmesh_en.

More Help topics

[Gradient mesh](#)

“Apply a gradient to an object” on page 190

Create a mesh object with an irregular pattern of mesh points

- 1 Select the Mesh tool , and select a fill color for the mesh points.
- 2 Click where you want to position the first mesh point.

The object is converted to a mesh object with the minimum number of mesh lines.

- 3 Continue clicking to add additional mesh points. Shift-click to add a mesh point without changing to the current fill color.

Create a mesh object with a regular pattern of mesh points

- 1 Select the object and choose Object > Create Gradient Mesh.
- 2 Set the number of rows and columns, and select the direction of the highlight from the Appearance menu:

Flat Applies the object’s original color evenly across the surface, resulting in no highlight.

To Center Creates a highlight in the center of the object.

To Edge Creates a highlight on the edges of the object.

- 3 Enter a percentage of white highlight to apply to the mesh object. A value of 100% applies maximum white highlight to the object; a value of 0% applies no white highlight to the object.

Convert a gradient-filled object to a mesh object

- 1 Select the object and choose Object > Expand.
- 2 Select Gradient Mesh, and click OK.

The selected object is converted to a mesh object that takes the shape of the gradient, either circular (radial) or rectangular (linear).

Convert a mesh object back to a path object

- ❖ Select the mesh object, choose Object > Path > Offset Path, and then enter zero for the offset value.

Edit mesh objects

You can edit a mesh object by adding, deleting, and moving mesh points; changing the color of mesh points and mesh patches; and converting the mesh object back to a regular object.

❖ Edit a mesh object by doing any of the following:

- To add a mesh point, select the Mesh tool  and select a fill color for the new mesh points. Then click anywhere in the mesh object.
- To delete a mesh point, Alt-click (Windows) or Option-click (Mac OS) the mesh point with the Mesh tool.
- To move a mesh point, drag it with the Mesh tool or Direct Selection tool. Shift-drag a mesh point with the Mesh tool to keep the mesh point on a mesh line. This is a convenient way to move a mesh point along a curved mesh line without distorting the mesh line.

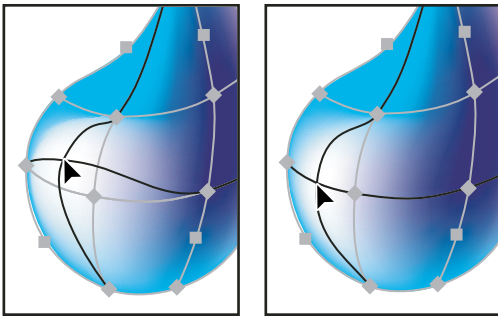

Dragging to move mesh point (left) compared to Shift- dragging with the Mesh tool to constrain the point to the mesh line (right)

- To change the color of a mesh point or patch, Select the mesh object, and then drag a color from the Color panel or Swatches panel onto the point or patch. Or, deselect all objects and select a fill color. Then select the mesh object and use the Eyedropper tool to apply the fill color to mesh points or patches.

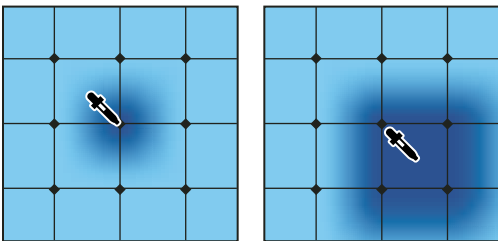

Adding color to a mesh point (left) compared to adding color to a mesh patch (right)

Set transparency for gradient meshes

You can set transparency and opacity values within gradient meshes. Transparency and opacity values can be assigned to individual mesh nodes. To assign transparency values:

- 1 Select one or more mesh nodes or patches.
- 2 Set the opacity from the Opacity slider in Transparency Panel, Control Panel, or the Appearance panel.

Note: If you save the object to legacy format or EPS or PDF, the transparency on the mesh object is retained by creating an opacity mask.

Patterns

About patterns

Illustrator comes with many patterns that you can access in the Swatches panel and in the Illustrator Extras folder on the Illustrator CD. You can customize existing patterns and design patterns from scratch with any of the Illustrator tools. Patterns intended for filling objects (*fill patterns*) differ in design and tiling from patterns intended to be applied to a path with the Brushes panel (*brush patterns*). For best results, use fill patterns to fill objects and brush patterns to outline objects.

When designing patterns, it helps to understand how Adobe Illustrator tiles patterns:

- All patterns tile from left to right from the ruler origin (by default, the bottom left of the artboard) to the opposite side of the artwork. To adjust where all patterns in your artwork begin tiling, you can change the file's ruler origin.

Note: Ruler origin in CS5 is different from that in CS4. As a result, the appearance of tiling patterns may not match when you copy-paste objects from CS4 to CS5. For such objects, tiles can be transformed using the Transform panel to match the CS4 appearance.

- Fill patterns typically have only one tile.
- Brush patterns can consist of up to five tiles—for the sides, outer corners, inner corners, and the beginning and end of the path. The additional corner tiles enable brush patterns to flow smoothly at corners.
- Fill patterns tile perpendicular to the x axis.
- Brush patterns tile perpendicular to the path (with the top of the pattern tile always facing outward). Also, corner tiles rotate 90° clockwise each time the path changes direction.
- Fill patterns tile only the artwork within the *pattern bounding box*—an unfilled and unstroked (non-printing) rectangle backmost in the artwork. For fill patterns, the bounding box acts as a mask.
- Brush patterns tile artwork within the pattern bounding box and protruding from or grouped with it.

More Help topics

[“About fills and strokes”](#) on page 150

Guidelines for constructing pattern tiles

Follow these general guidelines for constructing pattern tiles:

- To make the pattern less complex so that it prints more rapidly, remove any unnecessary detail from the pattern artwork, and group objects that are painted with the same color so that they are adjacent in the stacking order.
- As you create your pattern tile, zoom in on the artwork to align elements more accurately, and then zoom out from the artwork for the final selection.
- The more complex the pattern, the smaller should be the selection used to create it; however, the smaller the selection (and the pattern tile it creates), the more copies are needed to create the pattern. Thus, a 1-inch-square tile is more efficient than a 1/4-inch-square tile. If you are creating a simple pattern, you can include multiple copies of the object within the selection intended for the pattern tile.
- To create simple line patterns, layer stroked lines of varying widths and colors, and place an unfilled, unstroked bounding box behind the lines to create a pattern tile.
- To make an organic or textural pattern appear irregular, vary the tile artwork subtly for a more realistic effect. You can use the Roughen effect to control variations.

- To ensure smooth tiling, close paths before defining the pattern.
- Enlarge your artwork view and check for flaws before defining a pattern.
- If you draw a bounding box around the artwork, make sure that the box is a rectangle, that it is the backmost object of the tile, and that it is unfilled and unstroked. To have Illustrator use this bounding box for a brush pattern, make sure that nothing protrudes from it.

Follow these additional guidelines when creating brush patterns:

- When possible, confine artwork to an unpainted bounding box so that you can control how the pattern tiles.
- Corner tiles must be square and have the same height as side tiles to align properly on the path. If you plan to use corner tiles with your brush pattern, align objects in the corner tiles horizontally with objects in the side tiles so that the patterns tile correctly.
- Create special corner effects for brush patterns using corner tiles.

More Help topics

[“Apply a fill color to an object”](#) on page 151

Create pattern swatches

- 1 Create artwork for the pattern.
- 2 (Optional) To control the spacing between pattern elements or to clip out portions of the pattern, draw a pattern bounding box (an unfilled rectangle) around the artwork you want to use as a pattern. Choose Object > Arrange > Send To Back to make the rectangle the backmost object. To use the rectangle as a bounding box for a brush or fill pattern, fill and stroke it with None.
- 3 Use the Selection tool to select the artwork and bounding box (if any) that will make up the pattern tile.
- 4 Do one of the following:
 - Choose Edit > Define Pattern, enter a name in the New Swatch dialog box, and click OK. The pattern displays in the Swatches panel.
 - Drag the artwork to the Swatches panel.

More Help topics

[“Guidelines for constructing pattern tiles”](#) on page 195

[“About swatches”](#) on page 122

Create seamless geometric patterns

- 1 Make sure that Smart Guides are turned on and that Snap To Point is selected in the View menu.
- 2 Select the geometric object. For precise positioning, position the Direct Selection tool on one of the object’s anchor points.
- 3 Begin dragging the object vertically from one of its anchor points; then press Alt+Shift (Windows) or Option+Shift (Mac OS) to copy the object and constrain its movement.
- 4 When the copy of the object has snapped into place, release the mouse button and then release the keys.
- 5 Using the Group Selection tool, Shift-click to select both objects, and begin dragging the objects horizontally by one of their anchor points; then press Alt+Shift (Windows) or Option+Shift (Mac OS) to create a copy and constrain the move.

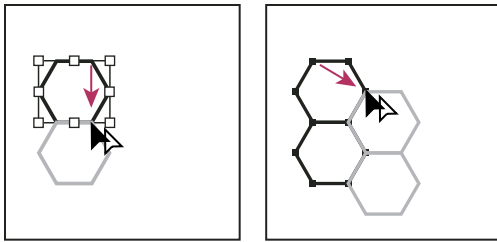

Select both objects (left) and drag to create a copy (right).

- 6 When the copy of the object has snapped into place, release the mouse button, and then release the keys.
- 7 Repeat steps 2 through 6 until you've built the pattern you want.
- 8 Use the Rectangle tool  to do one of the following:
 - For a fill pattern, draw a bounding box from the center point of the upper left object to the center point of the lower right object.
 - For a brush pattern, draw a bounding box that surrounds the objects and coincides with their outer boundaries. If the pattern is to be a corner tile, hold down Shift as you drag to constrain the bounding box to a square.

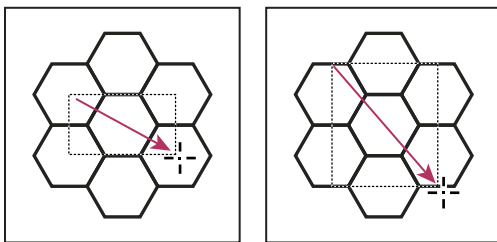

Bounding box for a fill pattern (left) compared to the bounding box for a brush pattern (right)

- 9 Paint the geometric objects the desired color.
- 10 Save the geometric objects as a pattern swatch.

Construct irregularly textured patterns

- 1 Choose View > Snap To Point.
- 2 Draw a bounding box. If you are creating a brush pattern, skip to step 13.
- 3 Draw the texture with the objects or lines that intersect only the left side of the bounding rectangle.
- 4 Using the Direct Selection tool, select the texture and the rectangle, and place the pointer on the lower left corner of the rectangle.
- 5 Drag the rectangle to the right; then press Alt+Shift (Windows) or Option+Shift (Mac OS) to create a copy and to constrain the move.

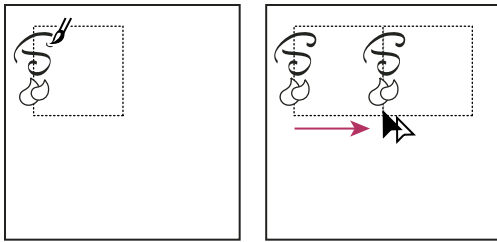

Draw texture on the left side of bounding box (left), and then copy texture and rectangle (right).

When the upper left corner point of the copy snaps to the upper right corner point of the bounding box, release the mouse button, and then release the keys.

 If you know the exact dimensions of the bounding box, you can select only the textures and use the Move command to specify a horizontal move the width of the rectangle. Be sure to click Copy instead of OK in the Move dialog box.

- 6 Click outside the rectangle to deselect it.
- 7 Select the right rectangle, and delete it.
- 8 Continue drawing your texture with only the objects or lines that intersect the top side of the rectangle.
- 9 When you finish with the top side only, select all of the lines or objects crossing the top side and the bounding box; then press Alt+Shift (Windows) or Option+Shift (Mac OS) and drag downward to create a copy and to constrain the move.

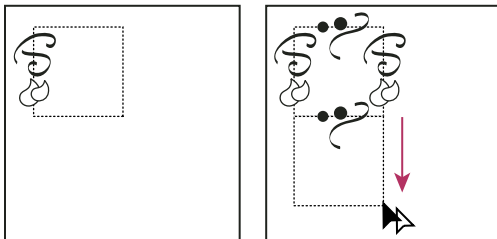

Draw texture on top side of bounding box (left), and then copy texture and rectangle (right).

- 10 When the upper left corner point of the copy snaps to the lower left corner point of the rectangle, release the mouse button and then the keys.
- 11 Deselect everything.
- 12 Select the lower rectangle and any objects that don't cross the top rectangle, and delete them.
- 13 Using the Pencil tool, fill the middle of the rectangle with your texture. Be careful not to intersect any of the rectangle edges. Paint the texture.
- 14 Save the artwork and rectangle as a pattern swatch.

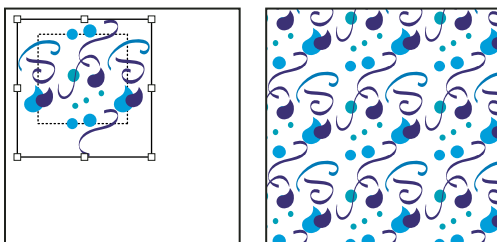

Defining artwork and rectangle as a pattern (left) compared to filling an area with the pattern (right)

Create corner tiles for brush patterns

Corner tiles lend special border effects when applying brush patterns. You can create corner tiles from scratch, or you can use a brush pattern's side tile as the basis for designing complementary outer and inner (reflected -135°) corner tiles.

- 1 Choose File > Open, locate a brush pattern file (supplied with Adobe Illustrator) that you want to use, and click Open.
- 2 Choose Window > Brushes. Select the tile you want to use, and drag it to the center of your artwork.
- 3 If the tile does not have a square bounding box, create a box that completely encompasses the artwork, the same height as the side tile. (Side tiles can be rectangular.) Fill and stroke the box with None, and choose Object > Arrange > Send To Back to make the box backmost in your artwork. (The bounding box helps you align the new tile.)
- 4 Select the tile and the bounding box.
- 5 To create an outer corner tile, use the Rotate tool  to rotate the tile and its bounding box 180° . Skip this step to create an inner corner tile.

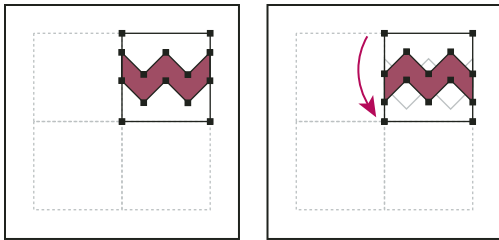

Pasted tile (left) compared to same tile rotated 180° (right)

- 6 Using the Rotate tool, Alt+Shift-click (Windows) or Option+Shift-click (Mac OS) the lower left corner of the bounding box. Enter a value of 90° , and click Copy to create a copy flush left of the first tile. This tile becomes the corner tile.
- 7 Using the Selection tool, drag the left tile down by the top right anchor point, pressing Alt+Shift (Windows) or Option+Shift (Mac OS) to make a copy and constrain the move so that you create a third tile beneath the second. When the copy's upper right anchor point snaps to the corner tile's lower right anchor point, release the mouse button and Alt+Shift (Windows) or Option+Shift (Mac OS).

You use the third copy for alignment.

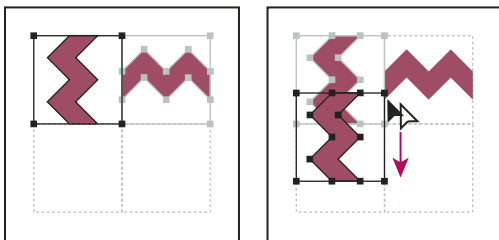

Rotate 90° and copy left tile (left), and then Alt-drag (Windows) or Option-drag (Mac OS) a corner tile to make a copy beneath it (right).

- 8 Select the artwork in the right tile. Drag it to the left, pressing Alt+Shift (Windows) or Option+Shift (Mac OS) so that the right-tile artwork overlaps that in the corner tile.

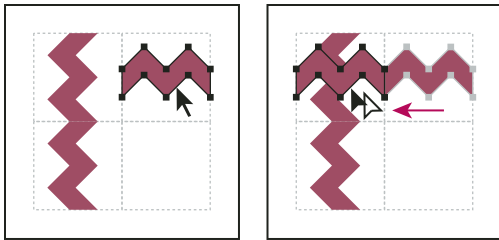

Copy (left) and move upper right tile over corner tile (right).

- 9 Edit the corner tile so that its artwork lines up vertically and horizontally with the tiles next to it. Select and delete any portions of the tile that you do not want in the corner, and edit the remaining art to create the final outer corner tile.

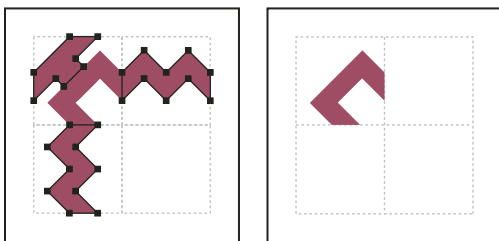

Deleting unnecessary elements (left) produces a final outer corner tile (right).

- 10 Select all of the tile parts including the bounding box.
- 11 Save the new pattern as a swatch.
- 12 Double-click the new pattern swatch to bring up the Swatch Options dialog box, name the tile as a variation of the original (for example, use the suffix “outer”), and click OK.

More Help topics

[“Create or modify brushes”](#) on page 171

[“Brush options”](#) on page 172

Modify patterns

- 1 Make sure that nothing is selected in your artwork.
- 2 In the Swatches panel, select the pattern swatch you want to modify.
- 3 Drag the pattern swatch onto your artboard, and edit the pattern tile on the artboard.
- 4 Select the pattern tile, and Alt-drag (Windows) or Option-drag (Mac OS) the modified pattern on top of the old pattern swatch in the Swatches panel.

The pattern is replaced in the Swatches panel and is updated in the current file.

More Help topics

[“Swatches panel overview”](#) on page 122

[“Transform an object’s patterns”](#) on page 231

Chapter 6: Selecting and arranging objects

Selecting objects

Organizing and laying out your artwork in Adobe Illustrator is made easy with tools that enable you to select, position, and stack objects precisely. Tools are available that let you measure and align objects; group objects so that they are treated as a single unit; and selectively isolate, lock, or hide objects.

Options for selecting objects

Before you can modify an object, you need to distinguish it from the objects around it. You do that by *selecting* the object. Once you've selected an object, or a part of an object, you can edit it.

Illustrator provides the following selection methods and tools:

Isolation mode Lets you quickly isolate a layer, sublayer, path, or group of objects, from all other art in your document. When in isolation mode, all nonisolated objects in the document appear dimmed and are not selectable or editable.

Layers panel Lets you quickly and precisely select individual or multiple objects. You can select a single object (even if it's in a group), all objects within a layer, and entire groups.

Selection tool  Lets you select objects and groups by clicking or dragging over them. You can also select groups within groups and objects within groups.

Direct Selection tool  Lets you select individual anchor points or path segments by clicking on them, or select an entire path or group by selecting any other spot on the item. You can also select one or more objects in a group of objects.

Note: When in outline mode, the Direct Selection tool may select imported graphics that are near the tool's pointer. To avoid selecting unwanted graphics, lock or hide the graphics before making the selection.

Group Selection tool  Lets you select an object within a group, a single group within multiple groups, or a set of groups within the artwork. Each additional click adds all objects from the next group in the hierarchy.

Perspective Selection tool  Lets you bring objects and text in perspective, switch active planes, move objects in perspective, and move objects in perpendicular direction.

Lasso tool  Lets you select objects, anchor points, or path segments by dragging around all or part of the object.

Magic Wand tool  Lets you select objects of the same color, stroke weight, stroke color, opacity, or blending mode by clicking the object.

Live Paint Selection tool  Lets you select faces (areas enclosed by paths) and edges (portions of paths between intersections) of Live Paint groups.

Selection commands (located in the Select menu) Let you quickly select or deselect all objects, and select objects based on their position relative to other objects. You can select all objects of a specific type or that share specific attributes, and save or load selections. You can also select all objects in the active artboard.

 *To temporarily activate the last-used selection tool (Selection tool, Direct-Selection tool, or Group Selection tool) when using another type of tool, hold down Ctrl (Windows) or Command (Mac OS).*

For a video on selecting and manipulating objects, see www.adobe.com/go/vid0034.

More Help topics

[“Select paths, segments, and anchor points”](#) on page 68

Specify selection preferences

Selecting paths and points in complex images can be challenging. Using the Selection and Anchor Display preferences, you can specify the tolerance for pixel selection and choose other options that can make selection easier for a particular document.

- 1 Choose Edit > Preferences > Selection & Anchor Display (Windows) or Illustrator > Preferences > Selection & Anchor Display (Mac OS).

- 2 Specify any of the following Selection options:

Tolerance Specifies the pixel range for selecting anchor points. Higher values increase the width of the area around an anchor point that you can click to select it.

Object Selection By Path Only Specifies whether you can select a filled object by clicking anywhere in the object or whether you have to click a path.

Snap To Point Snaps objects to anchor points and guides. Specify the distance between the object and anchor point or guide when the snap occurs.

More Help topics

[“Select filled objects”](#) on page 206

[“Specify anchor point size preferences”](#) on page 53

Isolate artwork for editing

Isolation mode isolates objects so that you can easily select and edit particular objects or parts of objects. You can isolate any of the following: layers, sublayers, groups, symbols, clipping masks, compound paths, gradient meshes, and paths.

In Isolation mode, you can delete, replace, and add new art relative to the isolated art. As soon as you exit isolation mode, replaced or new art is added at the same location as the original isolated art. Isolation mode automatically locks all other objects so that only the objects in isolation mode are affected by the edits you make— you don't need to worry about what layer an object is on, nor do you need to manually lock or hide the objects you don't want affected by your edits.

Note: When you edit a symbol's definition, the symbol appears in isolation mode. (See [“Edit or redefine a symbol”](#) on page 104.)

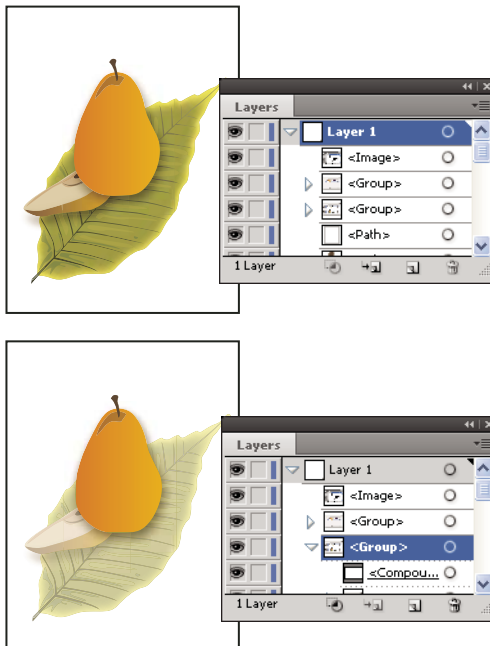

Isolating the pear group

When isolation mode is active, the isolated object appears in full color, while the rest of the artwork appears dimmed. The isolated object's name and location (sometimes referred to as bread crumbs) appears in the isolation mode border, and the Layers panel displays only the artwork in the isolated sublayer or group. When you exit isolation mode, the other layers and groups reappear in the Layers panel.

You can view isolated objects in outline mode or preview mode.

For a video on using layers and isolation mode, see www.adobe.com/go/vid0041.

Isolate a path, object, or group

❖ Do one of the following:

- Double-click the path or group using the Selection tool.
- Select the group, object, or path and click the Isolate Selected Object button  in the Control panel.
- Right-click (Windows) or Control-click (Mac OS) the group and choose Isolate Selected Group.
- Right-click (Windows) or Control-click (Mac OS) the path and choose Isolate Selected Path.
- Select the group, object, or path in the Layers panel and choose Enter Isolation Mode from the Layers panel menu or click the Isolate Selected Object button in the Control panel.

Isolate a path inside a group



- 1 Select the path by using the Direct-Selection tool or by targeting it in the Layers panel.
- 2 Click the Isolate Selected Object button  in the Control panel.

Isolate a layer or sublayer

❖ Select the layer or sublayer in the Layers panel, and choose Enter Isolation Mode from the Layers panel menu.

Exit isolation mode

❖ Do one of the following:

- Press Esc.
- Click the Exit Isolation Mode button  one or more times (if you've isolated a sublayer, one click takes you back a level, two clicks exits isolation mode).
- Click anywhere in the isolation mode bar.
- Click the Exit Isolation Mode button  in the Control panel.
- Using the Selection tool, double-click outside of the isolated group.
- Right-click (Windows) or Control-click (Mac OS) and choose Exit Isolation Mode.

Select behind objects

In Illustrator CS5, you can select objects that lie underneath other objects using Ctrl+click (Windows) or Command+click (Mac OS). The pointer changes to Select Behind on the first Ctrl+click (Windows) or Command+click (Mac OS). On subsequent usage of Ctrl+click (Windows) or Command+click (Mac OS), the selection iterates through the objects directly underneath the pointer position.

***Note:** To enable or disable this option, click Edit > Preferences > Selection and Anchor Display (Windows) or Illustrator > Preferences > Selection and Anchor Display (Mac OS). Then select the Control Click to Select Object Behind (Windows) or Command Click to Select Objects Behind (Mac OS) check box in the Selection area.*

Select the next object in the stacking order

You can select an object above or below a selected object in the stacking order. These commands do not work when in isolation mode.

❖ To select the nearest object above or below the selected object, choose Select > Next Object Above or Select > Next Object Below.

Select objects using the Layers panel

1 In the Layers panel, locate the object you want to select. You may have to click a toggle arrow to expand a layer or group, or scroll up or down in the panel to locate the object.

2 Do any of the following:

- To select individual objects, click in the object's selection column (between the target button and the scroll bar). Shift-click to add or to remove objects from the selection.
- To select all artwork in a layer or group, click in the layer's or group's selection column.
- To select all artwork in a layer based on the currently selected artwork, choose Select > Object > All On Same Layers.

Selection color boxes appear next to each selected item in the panel.

For a video on working with layers, see www.adobe.com/go/vid0041.

More Help topics



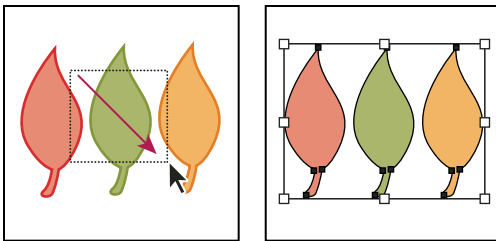

“[Layers panel overview](#)” on page 220

Select objects with the Selection tool

- 1 Select the Selection tool .
- 2 Do either of the following:
 - Click an object.
 - Drag a marquee around part or all of one or more objects.
- 3 To add or remove objects from the selection, hold down Shift and click or drag around the objects you want to add or remove.



Dragging over objects to select them

 When the Selection tool is over an unselected object or group, it changes to . When it is over a selected object or group, the tool changes to . When it is over an anchor point on an unselected object, a hollow square appears next to the arrow .

For a video on selecting objects, see www.adobe.com/go/vid0034.

More Help topics

“[Keys for selecting](#)” on page 478

Select objects with the Lasso tool

- 1 Select the Lasso tool .
- 2 Drag around or across the objects.

Select objects with the Magic Wand tool

Use the Magic Wand tool to select all objects in a document with the same or similar fill attributes (such as color and pattern).

You can customize the Magic Wand tool to select objects based on stroke weight, stroke color, opacity, or blending mode. You can also change the tolerances used by the Magic Wand tool to identify similar objects.

More Help topics

“[Workspace overview](#)” on page 5

Select objects based on fill color with the Magic Wand tool

- 1 Select the Magic Wand tool .
- 2 Do one of the following:
 - To create a new selection, click the object containing the attributes you want to select. All objects with the same attributes that were clicked are selected.

- To add to the current selection, press Shift and click another object containing the attributes you want to add. All objects with the same attributes that were clicked are also selected.
- To subtract from the current selection, press Alt (Windows) or Option (Mac OS) and click the object containing the attributes you want to subtract. All objects with the same attributes are removed from the selection.

Customize the Magic Wand tool

- 1 Do one of the following to open the Magic Wand panel:
 - Double-click the Magic Wand tool in the Tools panel.
 - Choose Window > Magic Wand.
- 2 To select objects according to their fill color, select Fill Color, and then enter a Tolerance value between 0 and 255 pixels for RGB or 0 and 100 pixels for CMYK.

Low tolerance values select objects that are very similar to the object you click; higher tolerance values select objects with a broader range of the selected property.
- 3 Choose Show Stroke Options from the Magic Wand panel menu, and do any of the following:
 - To select objects according to their stroke color, select Stroke Color, and then enter a Tolerance value between 0 and 255 pixels for RGB or 0 and 100 pixels for CMYK.
 - To select objects according to their stroke weight, select Stroke Weight, and then enter a Tolerance value between 0 and 1000 points.
- 4 Choose Show Transparency Options from the Magic Wand panel menu and do any of the following:
 - To select objects according to their transparency or blending mode, select Opacity, and then enter a Tolerance value between 0 and 100%.
 - To select objects according to their blending mode, select Blending Mode.

Select filled objects

The Object Selection By Path Only preference determines whether you can select a filled object by clicking anywhere within the object's area with the Selection or Direct Selection tools, or whether you must click a path segment or anchor point with these tools. By default, this preference is off. In some cases, you may want to turn the preference on—for example, when you work with overlapping filled objects and you want to easily select underlying objects.

Note: The Object Selection By Path Only preference is not applicable when selecting unfilled objects or when viewing artwork as outlines. In these cases, you can never select an object by clicking inside the object's path. (See “View artwork as outlines” on page 40.)

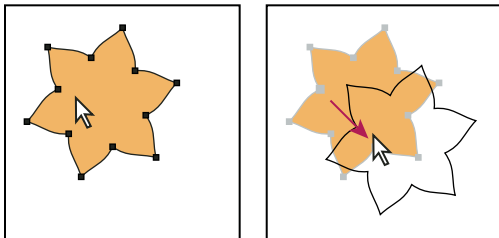

With Object Selection By Path Only deselected, clicking inside the object and dragging selects and moves an object.

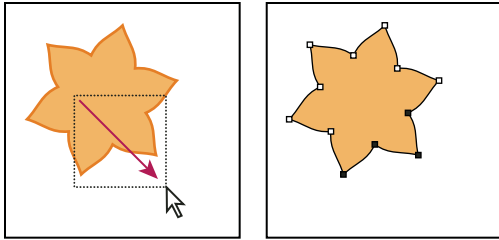

With Object Selection By Path Only selected, dragging with the Direct Selection tool selects points and segments within a marquee.

- ❖ Choose Edit > Preferences > Selection & Anchor Display (Windows) or Illustrator > Preferences > Selection & Anchor Display (Mac OS), and select Object Selection By Path Only.

Select groups and objects in a group

Once objects are grouped, selecting any part of the group with the Selection tool or the Lasso tool selects the entire group. If you are unsure whether an object is a part of a group, select it with the Selection tool.

The Direct-Selection tool and Lasso tool let you select a single path or object that is part of one group or several groups. If you have groups of objects within other groups, you can select the next group in the grouping hierarchy by using the Group-Selection tool. Each successive click adds another subset of grouped objects to the selection.



More Help topics

[“Group or ungroup objects”](#) on page 210



Select one or more groups with the Selection tool

- 1 Select the Selection tool .
- 2 Do one of the following to any object that's within the group:
 - Click the object.
 - Drag around part or all of the object.
- 3 To add or remove a group to the selection, hold down Shift while clicking the group to add or remove.

Select objects and groups within groups with the Selection tool

- 1 Select the Selection tool .
- 2 Double-click a group. The group appears in isolation mode.
- 3 Do any of the following:
 - Double-click to select further down into the group structure.
 -  *Double-clicking is a handy way to select objects (as opposed to faces and edges) within a Live Paint group.*
 - Click to select an object within the selected group.
 - Draw to add an object to the selected group.
- 4 Double-click outside the group to deselect the group.

Select a single object within a group

- 1 Do one of the following:
 - Select the Group Selection tool , and click the object.
 - Select the Lasso tool , and drag around or across the object's path.
 - Select the Direct Selection tool , and click within the object, or drag a marquee around part or all of the object's path.
- 2 To add or remove an object or group to or from the selection (with any selection tool), hold down Shift and select the object to add or remove.

Select objects and groups with the Group Selection tool

- 1 Select the Group Selection tool , and click an object that's within the group you want to select. The object is selected.
- 2 To select the object's parent group, click the same object again.
- 3 Click the same object again to select additional groups that are grouped with the selected group until you have selected everything you want to include in your selection.

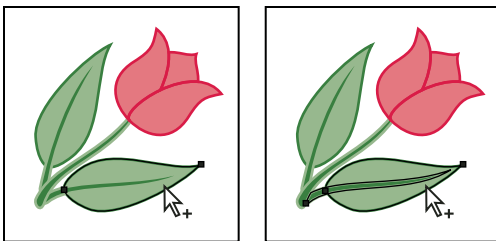

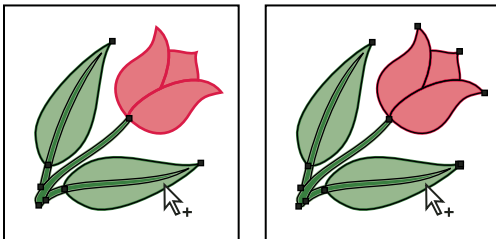

The first click with the Group Selection tool selects an object in a group (left); the second click selects the object's group (right).



The third click adds the next group to the selection (left); the fourth click adds the third group (right).

Select faces and edges in a Live Paint group

You select faces and edges of a Live Paint tool using the Live Paint Selection tool. If you want to select the entire Live Paint group, simply click it with the Selection tool.

- 1 Select the Live Paint Selection tool .
- 2 Move the tool over the Live Paint group until the face or edge you want to select is highlighted. (When the Live Paint Selection tool is over an edge, the tool changes to .)
- 3 Do any of the following:
 - Click to select the highlighted face or edge.
 - Drag a marquee around multiple faces or edges. Any face or edge that is fully or partially enclosed by the marquee is included in the selection.
 - Double-click a face or edge to select all connected faces/edges of the same color (flood select).

- Triple-click a face or edge to select all faces/edges of the same color (select same).

 If you have difficulty selecting a small face or edge, magnify the view or set the Live Paint Selection tool options to select only fills or strokes.

- 4 To add or remove faces and edges from the selection, hold down Shift and click the faces/edges you want to add or remove.

 To switch to the Eyedropper tool and sample fills and strokes, Alt-click (Windows) or Option-click (Mac OS) the fill and stroke you want.

More Help topics

[“About Live Paint”](#) on page 160

[“Keys for working with Live Paint groups”](#) on page 480

Live Paint Selection tool options

You access the Live Paint selection tool options by double-clicking the tool in the Tools panel.

Select Fills Selects the faces (the area within edges) of Live Paint groups.

Select Strokes Selects the edges of Live Paint groups.

Highlight Outlines the face or edge the cursor is currently over.

Color Sets the color for the highlight. You can choose a color from the menu or click the paint swatch to specify a custom color.

Width Specifies how thick to make the selection highlight.

Select objects by characteristic

You can select objects based on various groupings, including by formatting attribute, by layer, or by kind, such as brush strokes or clipping masks.

- 1 To select all objects in a file, choose Select > All. (To deselect all objects, choose Select > Deselect.)

Note: Using any selection tool, you can also deselect all objects by clicking or dragging at least 2 pixels away from any object.

- 2 To select all objects with the same attributes, select one with the attribute you want, choose Select > Same, and then choose an attribute from the list: Blending Mode, Fill & Stroke, Fill Color, Opacity, Stroke Color, Stroke Weight, Style, Symbol Instance, or Link Block Series.

Link Block Series automatically selects threaded text boxes. You can select one of the text boxes and then use this command to select all the other text boxes linked to that one. For more information see [“Threading text between objects”](#) on page 309.

 You can also use the Magic Wand tool to select all objects with the same color, stroke weight, stroke color, opacity, or blending mode.

- 3 To select all objects of a certain kind, deselect all artwork, choose Select > Object, and then choose an object type (Brush Strokes, Clipping Masks, Stray Points, or Text Objects).

Repeat or invert a selection

- To repeat the last selection command used, choose Select > Reselect.

- To select all unselected objects, and deselect all selected objects, choose Select > Inverse.

Save a selection

- 1 Select one or more objects, and choose Select > Save Selection.
- 2 In the Save Selection dialog box, type a name in the Name text box, and click OK.

You can reload a saved selection by choosing the selection name from the bottom of the Select menu. You can also delete or rename a selection by choosing Select > Edit Selection.

Grouping and expanding objects

Group or ungroup objects

You can combine several objects into a group so that the objects are treated as a single unit. You can then move or transform a number of objects without affecting their attributes or relative positions. For example, you might group the objects in a logo design so that you can move and scale the logo as one unit.

Grouped objects are stacked in succession on the same layer of the artwork and behind the frontmost object in the group; therefore, grouping may change the layering of objects and their stacking order on a given layer. If you select objects in different layers and then group them, the objects are grouped in the layer of the topmost selected object.

Groups can also be *nested*—that is, they can be grouped within other objects or groups to form larger groups. Groups appear as <Group> items in the Layers panel. You can use the Layers panel to move items in and out of groups.

- 1 Select the objects to be grouped or the group to be ungrouped.
- 2 Choose either Object > Group or Object > Ungroup.

More Help topics

[“Layers panel overview”](#) on page 220

Expand objects

Expanding objects enables you to divide a single object into multiple objects that make up its appearance. For example, if you expand a simple object, such as a circle with a solid-color fill and a stroke, the fill and the stroke each become a discrete object. If you expand more complex artwork, such as an object with a pattern fill, the pattern is divided into all of the distinct paths that created it.

You typically expand an object when you want to modify the appearance attributes and other properties of specific elements within it. In addition, expanding objects may be helpful when you want to use an object that is native to Illustrator (such as a mesh object) in a different application that doesn't recognize the object.

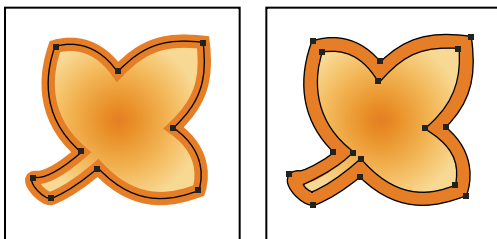

Before (left) and after (right) expanding an object that has a fill and stroke

💡 *Expanding is particularly helpful if you are having difficulty printing transparency effects, 3D objects, patterns, gradients, strokes, blends, flares, envelopes, or symbols.*

1 Select the object.

2 Choose Object > Expand.

If the object has appearance attributes applied to it, the Object > Expand command is dimmed. In this case, choose Object > Expand Appearance and then choose Object > Expand.

3 Set options, and then click OK:

Object Expands complex objects, including live blends, envelopes, symbol sets, and flares.

Fill Expands fills.

Stroke Expands strokes.

Gradient Mesh Expands gradients to a single mesh object.

Specify Sets the tolerance for color values between color stops. Higher numbers help maintain a smooth color transition; low numbers can create a more banded appearance.

💡 *Hold down Alt (Windows) or Option (Mac OS) as you choose Object > Expand to expand a gradient using the settings last entered in the Expand dialog box.*

Moving, aligning, and distributing objects

Move objects

You can move objects by dragging them with specific tools, by using the arrow keys on the keyboard, or by entering precise values in a panel or dialog box.

You can use *snapping* to help you position objects as you move them. For example, you can snap the pointer to guides and anchor points and snap object boundaries to gridlines. You can also use the Align panel to position objects in relation to each other.

You can then use the Shift key to constrain the movement of one or more objects so that they move in a precise horizontal, vertical, or diagonal direction relative to the current orientation of the x and y axes. You can also use the Shift key to rotate objects in multiples of 45°.

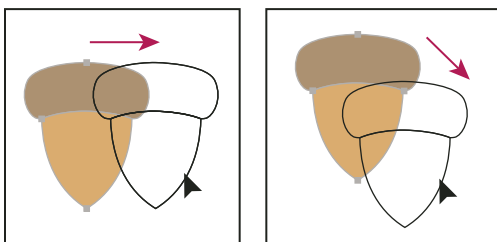

Hold down Shift while dragging or drawing to limit movement to the nearest 45° angle.

More Help topics

[“Use the grid”](#) on page 43

[“Rotate objects”](#) on page 216

[“Transform panel overview”](#) on page 230

[“Drawing pixel-aligned paths for web workflows”](#) on page 58

Move or duplicate an object by pasting

- 1 Select one or more objects.
- 2 Choose Edit > Cut to move the selection or Edit > Copy to duplicate the selection.
- 3 To paste an object into another file, open the file. (To paste between layers, see [“Pasting objects between layers”](#) on page 214.)
- 4 Choose one of the following commands:

Edit > Paste Pastes the object into the center of the active window.

Edit > Paste In Front Pastes the object directly in front of the selected object.

Edit > Paste In Back Pastes the object directly in back of the selected object.

Edit > Paste in Place Pastes artwork on the active artboard at the same position as the artboard from where the artwork is copied.

Edit > Paste on All Artboards Pastes artwork on all the artboards at the same location where the artwork is on the current artboard.

Move an object by dragging

- 1 Select one or more objects.
- 2 Drag the object to a new location.

If a selected object is filled, you can drag from anywhere on the object. If a selected object is unfilled, if you are viewing artwork as outlines, or if the Object Selection By Path Only preference is selected, you must drag from the object's path. (See [“Duplicate selections using drag and drop”](#) on page 227.)



You can use the Snap To Point command in the View menu to have the cursor snap to an anchor point or guide when you drag an object within 2 pixels of the anchor point or guide.

Move an object using the arrow keys

- 1 Select one or more objects.
- 2 Press the arrow key for the direction in which you want to move the object. Press Shift+arrow to move the object ten times the value specified by the Keyboard Increment preference.

The distance the object moves each time you press an arrow key is determined by the Keyboard Increment preference. The default distance is 1 point (1/72 of an inch, or .3528 millimeter). To change the Keyboard Increment preference, choose Edit > Preferences > General (Windows) or Illustrator > Preferences > General (Mac OS).

Move an object by a specific distance

- 1 Select one or more objects.
- 2 Choose Object > Transform > Move.



When an object is selected, you can also double-click the Selection, Direct Selection, or Group Selection tool to open the Move dialog box.

3 Do any of the following:

- To move the object left or right, enter either a negative value (moves left) or a positive value (moves right) in the Horizontal text box.
- To move the object up or down, enter either a negative value (moves down) or positive value (moves up) in the Vertical text box.
- To move the object by an angle that's relative to the object's *x* axis, enter either a positive angle (counterclockwise movement) or a negative angle (clockwise movement) in the Distance or Angle text box. You can also enter values between 180° and 360°; these values are converted to their corresponding negative values (for example, a value of 270° is converted to -90°).

4 If the objects contain a pattern fill, select Patterns to move the pattern. Deselect Objects if you want to move the pattern but not the objects.

5 Click OK, or click Copy to move a copy of the objects.

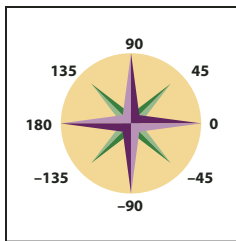

Directions relative to the x axis

Move an object using x and y coordinates

1 Select one or more objects.

2 In the Transform panel or Control panel, enter new values in either the X or Y text box, or both.

To change the reference point, click a white square on the reference point locator  before you enter the values.

Move multiple objects at once

1 Select one or more objects.

2 Choose Object > Transform > Transform Each.

3 Set the distance you want to move the selected objects in the Move section of the dialog box.

4 Do one of the following:

- To move the objects by the specified amounts, click OK.
- To move the objects randomly, but no more than the specified amounts, select the Random option. For example, if you draw a brick wall and want the bricks to appear slightly offset from each other instead of perfectly aligned, you could select the Random option. Then click OK.

Paste an object relative to other objects

1 Select the object you want to paste.

2 Choose Edit > Copy or Edit > Cut.

3 Select the object in front or in back of which you want to paste.

4 Choose Edit > Paste In Front or Edit > Paste In Back.

If you paste more than one object, all pasted objects appear in front or in back of the selected artwork. However, the relative painting order among the individual pasted objects remains the same.

Pasting objects between layers

The Paste Remembers Layers option determines where artwork is pasted in the layer hierarchy. By default, Paste Remembers Layers is off, and artwork is pasted into whichever layer is active in the Layers panel. When Paste Remembers Layers is on, artwork is pasted into the layer from which it was copied, regardless of which layer is active in the Layers panel.

You set this option by selecting Paste Remembers Layers from the Layers panel menu. A check mark displays when the option is on.

 *Turn on Paste Remembers Layers if you're pasting artwork between documents and you want to automatically place it into a layer of the same name as that from which it originated. If the target document does not have a layer of the same name, Illustrator creates a new layer.*

More Help topics

[“Layers panel overview”](#) on page 220

Paste in place and paste on all artboards

The Paste in Place command pastes artwork on the active artboard. To use this command, click Edit > Paste in Place. The keyboard shortcut is Ctrl+Shift+V (Windows) or Cmd+Shift+V (Mac).

The Paste on All Artboards command pastes the selected artwork on all the artboards. Before using the Paste on All Artboards command, make sure that the artboard from which you are copying the object, is the active artboard.

To use the Paste on All Artboards command, click Edit > Paste on All Artboards when you cut or copy the artwork.

If you copy artwork, and then select Paste on All Artboards, the artwork is repasted on the artboard from where it is copied. (Recommended) Cut and then paste objects if you do not need to modify the original objects before using the Paste on All Artboards command.

***Note:** Paste in Place and Paste on All Artboards commands paste the object at the same position as the copied objects referenced from the active artboard at the time of copying.*

Align and distribute objects

You use the Align panel (Window > Align) and the align options in the Control panel to align or distribute selected objects along the axis you specify. You can use either the object edges or anchor points as the reference point, and you can align to a selection, an artboard, or a key object. A key object is one specific object in a selection of multiple objects.

The Align options are visible in the Control panel when an object is selected. If they do not appear, choose Align from the Control panel menu.

 *By default, Illustrator calculates alignment and distribution based on the objects' paths. However, when working with objects that have different stroke weights, you can use the edge of the stroke to calculate alignment and distribution instead. To do this, select Use Preview Bounds from the Align panel menu.*

For a video on aligning and distributing objects, see www.adobe.com/go/vid0035.

More Help topics

[“Workspace overview”](#) on page 5

[“Using multiple artboards”](#) on page 31

Align or distribute relative to the bounding box of all selected objects

- 1 Select the objects to align or distribute.
- 2 In the Align panel or Control panel, select Align To Selection , and then click the button for the type of alignment or distribution you want.

Align or distribute relative to one anchor point

- 1 Click the Direct-Selection tool, hold down Shift, and select the anchor points you want to align or distribute. The last anchor point you select becomes the key anchor point.
The Align To Key Anchor  option is automatically selected in the Align panel and Control panel.
- 2 In the Align panel or Control panel, click the button for the type of alignment or distribution you want.

Align or distribute relative to a key object

- 1 Select the objects to align or distribute.
- 2 Click again on the object you want to use as a key object (you don't need to hold down Shift as you click this time).
A blue outline appears around the key object, and Align To Key Object  is automatically selected in the Control panel and Align panel.
- 3 In the Align panel or Control panel, click the button for the type of alignment or distribution you want.
Note: To stop aligning and distributing relative to an object, click again on the object to remove the blue outline, or choose *Cancel Key Object* from the Align panel menu.

Align or distribute relative to an artboard

- 1 Select the objects to align or distribute.
- 2 Using the Selection tool, Shift-click in the artboard you want to use to activate it. The active artboard has a darker outline than the others.
- 3 In the Align panel or Control panel, select Align To Artboard , and then click the button for the type of alignment or distribution you want.

Distribute objects by specific amounts

You can distribute objects using exact distances between their paths.

- 1 Select the objects to distribute.
- 2 In the Align panel, enter the amount of space to appear between objects in the Distribute Spacing text box.
If the Distribute Spacing options aren't displayed, select *Show Options* from the panel menu.
- 3 Use the Selection tool  to click the path of the object you want the other objects to distribute around. The object you click will remain fixed in its position.
- 4 Click either the Vertical Distribute Space button or the Horizontal Distribute Space button.

Rotating and reflecting objects

Rotate objects

Rotating an object turns it around a fixed point that you designate. The default reference point is the object's center point. If you have multiple objects in a selection, the objects will rotate around a single reference point, which is the center point of the selection or bounding box by default. To rotate each object around its own center point, use the Transform Each command.

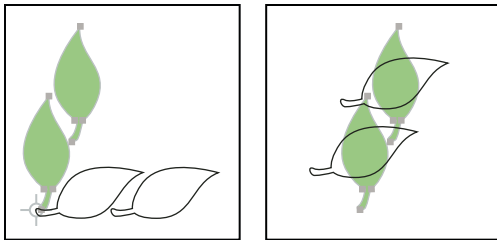

Results of Rotate tool (left) compared to Transform Each command (right)



More Help topics

[“Transform panel overview”](#) on page 230



[“Move objects”](#) on page 211

[“Scale objects”](#) on page 232

Rotate an object using the bounding box

- 1 Select one or more objects.
- 2 With the Selection tool , move the pointer outside the bounding box and near a bounding box handle so that the pointer changes to , and then drag.

Rotate an object with the Free Transform tool

- 1 Select one or more objects.
- 2 Select the Free Transform tool .
- 3 Position the pointer anywhere outside the bounding box so that the pointer changes to , and then drag.

Rotate an object with the Rotate tool

- 1 Select one or more objects.
- 2 Select the Rotate tool .
- 3 Do any of the following:
 - To rotate the object around its center point, drag in a circular motion anywhere in the document window.
 - To rotate the object around a different reference point, click once anywhere in the document window to reposition the reference point. Then move the pointer away from the reference point and drag in a circular motion.
 - To rotate a copy of the object instead of the object itself, hold down Alt (Windows) or Option (Mac OS) after you start to drag.

For finer control, drag farther from the object's reference point.

Rotate an object by a specific angle

You can control the exact angle of rotation with the Rotate command.

- 1 Select one or more objects.
- 2 Do one of the following:
 - To rotate around a different reference point, select the Rotate tool. Then Alt-click (Windows) or Option-click (Mac OS) where you want the reference point to be in the document window.
 - To rotate around the center point, choose Object > Transform > Rotate, or double-click the Rotate tool.
- 3 Enter the rotation angle in the Angle text box. Enter a negative angle to rotate the object clockwise; enter a positive angle to rotate the object counterclockwise.
- 4 If the objects contain a pattern fill, select Patterns to rotate the pattern. Deselect Objects if you want to rotate the pattern but not the objects.
- 5 Click OK, or click Copy to scale a copy of the objects.

 *To place multiple copies of the object in a circular pattern around a reference point, move the reference point away from the center of the object, click Copy, and then repeatedly choose Object > Transform > Transform Again.*

Rotate an object with the Transform panel

- 1 Select one or more objects.
- 2 Do one of the following:
 - To rotate the object around its center point, enter a value for the Angle option in the panel.
 - To rotate the object around a different reference point, click a white square on the reference point locator  in the panel, and enter a value for the Angle option.

 *You can also call up the Transform panel by clicking X, Y, W, or H in the Control panel.*

- 3 You can rotate a symbol around its registration point, using the Transform panel. For more information see [“Symbol registration point”](#) on page 100.

Rotate multiple objects individually

- 1 Select the objects to rotate.
- 2 Choose Object > Transform > Transform Each.
- 3 Do either of the following in the Rotate section of the dialog box:
 - Click the angle icon or drag the angle line around the icon.
 - In the Angle text box, enter an angle between -360° and 360° .
- 4 Click OK, or click Copy to rotate a copy of each object.

Rotate the x and y axes of a document

By default, the x and y axes are parallel to the horizontal and vertical sides of the document window.

- 1 Choose Edit > Preferences > General (Windows) or Illustrator > Preferences > General (Mac OS).
- 2 Specify an angle in the Constrain Angle text box. A positive angle rotates the axes counterclockwise; a negative angle rotates the axes clockwise.

Rotating the axes is useful if your artwork consists of elements that are rotated to the same angle, such as a logo and text displayed on a 20° angle. Instead of rotating each element you add to the logo, you can simply rotate the axes by 20°. Everything you draw is created along the new axes.

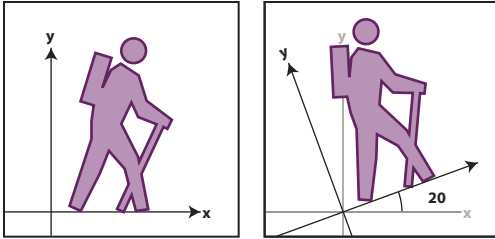

Object aligned with default axes (left) compared to alignment with axes rotated 20° (right)

The following objects and actions are *not* affected by the new axes:

- Objects that already exist
- Rotating and blending
- Drawing with the Pencil or Live Trace tool

Reflect or flip objects

Reflecting an object flips the object across an invisible axis that you specify. You can reflect objects using the Free Transform tool, the Reflect tool, or the Reflect command. If you want to specify an axis from which to reflect, use the Reflect tool.

 To create a mirror image of an object, you can copy while reflecting.

Reflect an object with the Free Transform tool

- 1 Select the object to reflect.
- 2 Select the Free Transform tool .
- 3 Do one of the following:
 - Drag a handle of the bounding box past the opposite edge or handle until the object is at the desired level of reflection.
 - To maintain the object's proportions, hold down Shift while dragging a corner handle past the opposite handle.

Reflect an object with the Reflect tool

- 1 Select the object.
- 2 Select the Reflect tool .
- 3 To draw the invisible axis across which you want the object to reflect, click anywhere in the document window to set one point of the axis. The pointer changes to an arrowhead.
- 4 Position the pointer at another point to define the invisible axis, and do one of the following:
 - Click to set the second point of the invisible axis. When you click, the selected object flips over the defined axis.

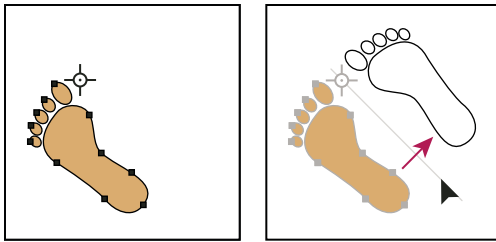

Click to set one point of the axis (left), then click again to set the other axis point and reflect the object across the axis (right).

- To reflect a copy of the object, hold down Alt (Windows) or Option (Mac OS) and click to set the second point of the invisible axis.
- Adjust the axis of reflection by dragging instead of clicking. Shift-drag to constrain the angle by 45°. As you drag, the invisible axis of reflection rotates around the point you clicked in step 3 and an outline of the object appears reflected. When the outline is in the desired position, release the mouse button.

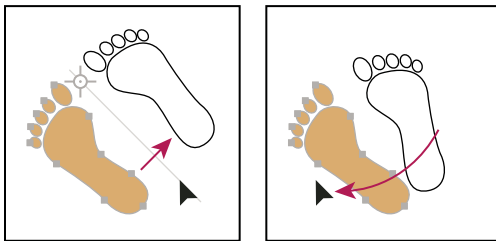

Dragging the second point of the reflect axis to rotate the axis

For finer control, drag farther from the object's reference point.

Reflect by specifying an axis

- 1 Select the object to reflect.
 - To reflect the object around the object's center point, choose Object > Transform > Reflect or double-click the Reflect tool .
 - To reflect the object around a different reference point, Alt-click (Windows) or Option-click (Mac OS) anywhere in the document window.
- 2 In the Reflect dialog box, select the axis across which you want the object to be reflected. You can reflect an object across a horizontal, a vertical, or an angled axis.
- 3 If the object contains patterns and you want to reflect the patterns, select Patterns. (To reflect only the patterns, deselect Objects.)
- 4 To preview the effect before you apply it, select Preview.
- 5 Do one of the following:
 - To reflect the object, click OK.
 - To reflect a copy of the object, click Copy.

Using layers

About layers

When creating complex artwork, it's a challenge to keep track of all the items in your document window. Small items get hidden under larger items, and selecting artwork becomes difficult. Layers provide a way to manage all the items that make up your artwork. Think of layers as clear folders that contain artwork. If you reshuffle the folders, you change the stacking order of the items in your artwork. You can move items between folders and create subfolders within folders.

The structure of layers in your document can be as simple or complex as you want it to be. By default, all items are organized in a single, parent layer. However, you can create new layers and move items into them, or move elements from one layer to another at any time. The Layers panel provides an easy way to select, hide, lock, and change the appearance attributes of artwork. You can even create template layers, which you can use to trace artwork, and exchange layers with Photoshop.

For a video on using layers and groups, see www.adobe.com/go/vid0041. For information on using layers to create animations, see www.adobe.com/go/learn_ai_tutorials_layers_en.

More Help topics

[Using layers to create animations](#)

Layers panel overview

You use the Layers panel (Window > Layers) to list, organize, and edit the objects in a document. By default, every new document contains one layer, and each object you create is listed under that layer. However, you can create new layers and rearrange items to best suit your needs.

By default, Illustrator assigns a unique color (up to nine colors) to each layer in the Layers panel. The color displays next to the layer name in the panel. The same color displays in the illustration window in the bounding box, path, anchor points, and center point of a selected object. You can use this color to quickly locate an object's corresponding layer in the Layers panel, and you can change the layer color to suit your needs.

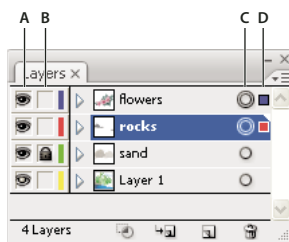

When an item in the Layers panel contains other items, a triangle appears to the left of the item's name. Click the triangle to show or hide the contents. If no triangle appears, the item contains no additional items.





Layers panel

A. Visibility column B. Edit column C. Target column D. Selection column

The Layers panel provides columns to the left and right of the listings. Click in a column to control the following characteristics:

Visibility column Indicates whether items in the layers are visible  or hidden (blank space), or whether they are template  layers or outline  layers.

Edit column Indicates whether items are locked or unlocked. The lock icon  indicates that the item is locked and cannot be edited; a blank space indicates that the item is unlocked and can be edited.

Target column Indicates whether items are targeted for application of effects and edit attributes in the Appearance panel. When the target button appears as a double ring icon (either  or ) , the item is targeted; a single ring icon indicates that the item is not targeted.

Selection column Indicates whether items are selected. A color box appears when an item is selected. If an item, such as a layer or group, contains some objects that are selected and other objects that are unselected, a smaller selection color box appears next to the parent item. If all of the objects within the parent item are selected, the selection color boxes are the same size as the marks that appear next to selected objects.

You can use the Layers panel to display some items as outlines and other items as they will appear in the final artwork. You also can dim linked images and bitmap objects to make it easier to edit artwork on top of the image. This is especially useful when tracing a bitmap image.

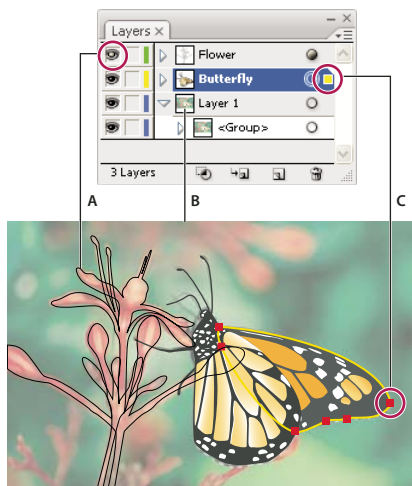

Display options for layered artwork

A. Object displayed in Outline view B. Bitmap object dimmed to 50% C. Selected object displayed in Preview view

More Help topics

[“Workspace overview”](#) on page 5

[“View artwork as outlines”](#) on page 40

[“Trace artwork”](#) on page 94

Change the display of the Layers panel

- 1 Choose panel Options from the Layers panel menu.
- 2 Select Show Layers Only to hide paths, groups, and collective elements in the Layers panel.
- 3 For Row Size, select an option to specify the height of rows. (To specify a custom size, enter a value between 12 and 100.)
- 4 For Thumbnails, select a combination of layers, groups, and objects for which to display thumbnail previews.

***Note:** Displaying thumbnails in the Layers panel may result in slow performance when you are working with complex files. Turn off layer thumbnails to improve performance.*

Set layer and sublayer options

1 Do one of the following:

- Double-click the item name in the Layers panel.
- Click the item name and choose Options For <item name> from the Layers panel menu.
- Choose New Layer or New Sublayer from the Layers panel menu.

2 Specify any of the following:

Name Specifies the name of the item as it appears in the Layers panel.

Color Specifies the layer's color setting. You can either choose a color from the menu or double-click the color swatch to select a color.

Template Makes the layer a template layer.

Lock Prevents changes to the item.

Show Displays all artwork contained in the layer on the artboard.

Print Makes the artwork contained in the layer printable.



Preview Displays the artwork contained in the layer in color instead of as outlines.

Dim Images Reduces the intensity of linked images and bitmap images contained in the layer to the specified percentage.

Create a new layer

1 In the Layers panel, click the name of the layer above which (or in which) you want to add the new layer.

2 Do one of the following:

- To add a new layer above the selected layer, click the Create New Layer button  in the Layers panel.
- To create a new sublayer inside the selected layer, click the Create New Sublayer button  in the Layers panel.

 *To set options when you create a new layer, choose New Layer or New Sublayer from the Layers panel menu.*

For different drawing modes, Illustrator provides several options, which include:

- The Draw Behind mode automatically creates an active new layer behind the active layer.
- In draw behind mode, artwork is drawn behind all artwork on a selected layer if no artwork is selected.

Move an object to a different layer

1 Select the object.

2 Do one of the following:

- Click the name of the desired layer in the Layers panel. Then choose Object > Arrange > Send To Current Layer.
- Drag the selected-art indicator , located at the right of the layer in the Layers panel, to the layer you want.

 *You can move objects or layers into a new layer by selecting them and choosing Collect In New Layer from the Layers panel menu. Hold down Ctrl (Windows) or Command (Mac OS) to select nonadjacent items; hold down Shift to select adjacent items.*

Release items to separate layers

The Release To Layers command redistributes all of the items in a layer into individual layers and can build new objects in each layer based on the object's stacking order. You can use this feature to prepare files for web animation work.

- 1 In the Layers panel, click the name of a layer or group.
- 2 Do one of the following:
 - To release each item to a new layer, choose Release To Layers (Sequence) from the Layers panel menu.
 - To release items into layers and duplicate objects to create a cumulative sequence, choose Release To Layers (Build) from the Layers panel menu. The bottommost object appears in each of the new layers, and the topmost object only appears in the topmost layer. For example, assume Layer 1 contains a circle (bottommost object), a square, and a triangle (topmost object). This command creates three layers—one with a circle, square, and triangle; one with a circle and square; and one with just a circle. This is useful for creating cumulative animation sequences.

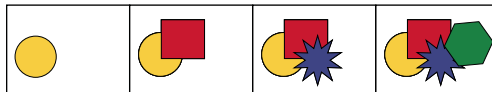
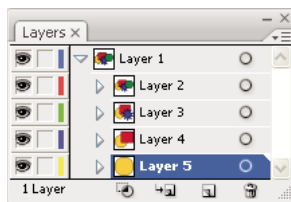

Release To Layers (Build) command creates new layers.

Consolidate layers and groups

Merging and flattening layers are similar in that they both let you consolidate objects, groups, and sublayers into a single layer or group. With merging, you can select which items you want to consolidate; with flattening, all visible items in the artwork are consolidated in a single layer. With either option, the stacking order of the artwork remains the same, but other layer-level attributes, such as clipping masks, aren't preserved.

- To merge items into a single layer or group, hold down Ctrl (Windows) or Command (Mac OS) and click the names of the layers or groups that you want to merge. Alternatively, hold down Shift to select all listings in between the layer or group names you click. Then, select Merge Selected from the Layers panel menu. Note that items will be merged into the layer or group that you selected last.

Layers can only merge with other layers that are on the same hierarchical level in the Layers panel. Likewise, sublayers can only merge with other sublayers that are within the same layer and at the same hierarchical level. Objects can't be merged with other objects.

- To flatten layers, click the name of the layer into which you want to consolidate the artwork. Then select Flatten Artwork from the Layers panel menu.

Locate an item in the Layers panel

When you select an item in your document window, you can quickly locate the corresponding item in the Layers panel using the Locate Object command. This command is especially helpful for locating items in collapsed layers.

- 1 Select an object in the document window. If you select more than one object, the frontmost object in the stacking order will be located.
- 2 Choose Locate Object from the Layers panel menu. This command changes to Locate Layer if the Show Layers Only panel option is selected.

Locking, hiding, and deleting objects

Lock or unlock objects or layers

Locking objects prevents you from selecting and editing them. You can quickly lock multiple paths, groups, and sublayers by locking their parent layer.

- To lock objects, click the edit column button (to the right of the eye icon) in the Layers panel for the object or layer you want to lock. Drag across multiple edit column buttons to lock multiple items. Alternatively, select the objects you want to lock, and then choose Object > Lock > Selection.
- To unlock objects, click the lock icon  in the Layers panel for the object or layer you want to unlock.

You can also use the following commands to lock and unlock objects:

- To lock all objects that overlap the area of the selected object and that are in the same layer, select the object, and then choose Object > Lock > All Artwork Above.
- To lock all layers other than the layer that contains a selected item or group, choose Object > Lock > Other Layers or choose Lock Others from the Layers panel menu.
- To lock all the layers, select all the layers in the Layers panel, and then choose Lock All Layers from the panel menu.
- To unlock all objects in the document, choose Object > Unlock All.
- To unlock all objects within a group, select an unlocked and visible object within the group. Hold down Shift+Alt (Windows) or Shift+Option (Mac OS) and choose Object > Unlock All.
- If you locked all layers, choose Unlock All Layers from the Layers panel menu to unlock them.

Note: The Lock menus are disabled when you're in isolation mode.

More Help topics

[“Layers panel overview”](#) on page 220

Hide or show objects or layers

Choose from the following methods:

- In the Layers panel, click the eye icon  next to the item you want to hide. Click again to redisplay the item. If you hide a layer or group, all items in the layer or group are hidden.
- Drag across multiple eye icons to hide multiple items.
- Select an object you want to hide, and choose Object > Hide > Selection.
- To hide all objects above an object in a layer, select the object and choose Object > Hide > All Artwork Above.

- To hide all unselected layers, choose Hide Others from the Layers panel menu, or Alt-click (Windows) or Option-click (Mac OS) the eye icon for the layer you want to show. Alternatively, to hide all other layers other than the layer that contains the selected object or group, choose Object > Hide > Other Layers.
- To show all objects, choose Object > Show All. All previously hidden objects are shown. Any previously selected objects are selected.
- To show all layers and sublayers, select Show All Layers from the Layers panel menu. Hidden objects aren't displayed by this command, only hidden layers.
- To show all objects within a group, select an unlocked and visible object in the group. Hold down Shift+Alt (Windows) or Shift+Option (Mac OS) and choose Object > Show All.

Note: The Show All and Hide menus are disabled when you're in isolation mode.

More Help topics

[“Layers panel overview”](#) on page 220

Delete objects

❖ Do one of the following:

- Select the objects and then press Backspace (Windows) or Delete.
- Select the objects and then choose Edit > Clear or Edit > Cut.
- Select the items you want to delete in the Layers panel, and then click the Delete icon . Alternatively, drag the item name in the Layers panel to the Delete icon in the panel, or choose Delete “Layer name” from the Layers panel menu.

Deleting a layer also deletes all artwork that is in the layer. For example, if you delete a layer that contains sublayers, groups, paths, and clipping sets, all those elements will be deleted along with the layer.

Note: A document must have a least one layer. If a document has only one layer, the Delete icon and Delete command are not available.

More Help topics

[“Layers panel overview”](#) on page 220

Stacking objects

Specify where to add new objects in the stacking order

Illustrator stacks successively drawn objects, beginning with the first object drawn.

How objects are stacked determines how they display when they overlap. The stacking order of objects depends on the drawing mode you are using. When a new layer is created in the Draw Normal mode, it is placed right above the active layer and any new objects are drawn at the top of active layer. However, in the Draw Behind mode, when a new layer is created, it is placed right below the active layer and any new objects are drawn behind the selected object (or at the bottom of the active layer if no objects are selected).

You can change the stacking order (also called the *painting order*) of objects in your artwork at any time using either the Layers panel or Object > Arrange commands.

- ❖ In the Layers panel, do either of the following:
 - In the Draw Behind mode, select the object below which you want to add the new object.
 - In the Draw Normal mode, to add the new object to the top of a layer, click the name of the layer to make it active. In the Draw Behind mode, to add the new object to the bottom of a layer, click the name of the layer to make it active.

Change the stacking order using the Layers panel

The artwork at the top of the Layers panel is at the front of the stacking order, while artwork at the bottom of the Layers panel is at the back of the stacking order. Within a layer, objects are also stacked hierarchically. By creating multiple layers in your artwork, you can control how overlapping objects are displayed.

- ❖ Do any of the following:
 - Drag the item's name and release the mouse button when black insertion marks appear in the desired position. Black insertion marks appear either between two other items in the panel or on the left and right edges of a layer or group. Items that are released over a layer or group are moved above all other objects in the item.
 - Click in the item's selection column (between the target button and the scroll bar), drag the selection color box to a different item's selection color box, and release the mouse button. If the item's selection color box is dragged to an object, the item is moved above the object; if it's dragged to a layer or group, the item is moved above all other objects in the layer or group.
 - To reverse the order of items in the Layers panel, hold down Ctrl (Windows) or Command (Mac OS) and click the names of the items whose order you want to reverse. The items must be at the same level in the layer hierarchy. For example, you can select two top-level layers, but you cannot select two paths that are in different layers. Then select Reverse Order from the Layers panel menu.

Note: You cannot move a path, group, or collective element to the top position in the Layers panel—only layers can reside at the top of the layer hierarchy.

More Help topics

[“Layers panel overview”](#) on page 220

Change the stacking order using commands

- ❖ Do any of the following:
 - To move an object to the top or bottom position in its group or layer, select the object you want to move and choose Object > Arrange > Bring To Front or Object > Arrange > Send To Back.
 - To move an object by one object to the front or one object to the back of a stack, select the object you want to move, and choose Object > Arrange > Bring Forward or Object > Arrange > Send Backward.

For an example of how changing the stacking order in an illustration changes the design, see www.adobe.com/go/learn_ai_tutorials_depth_en. This tutorial is available only in English.

Duplicating objects

Duplicate objects by dragging

- 1 Select one or more objects.
- 2 Select the Selection, Direct Selection, or Group Selection.
- 3 Alt-drag (Windows) or Option-drag (Mac OS) the selection (but not a handle on the bounding box).

Duplicate objects by using the Layers panel

You can quickly duplicate objects, groups, and entire layers by using the Layers panel.

- 1 Select the items you want to duplicate in the Layers panel.
- 2 Do one of the following:
 - Choose Duplicate “*Layer name*” from the Layers panel menu.
 - Drag the item in the Layers panel to the New Layer button  at the bottom of the panel.
 - Start to drag the item to a new position in the Layers panel, and then hold down Alt (Windows) or Option (Mac OS). Release the mouse button when the indicator is in the position where you want to place the duplicated item. If you release the mouse button when the indicator is pointing to a layer or group, the duplicated item is added to the top of the layer or group. If you release the mouse button when the indicator is between items, the duplicated item will be added in the specified position.

Duplicate selections using drag and drop

You can use the Clipboard to transfer selections between an Illustrator file and other Adobe software including Adobe Photoshop and Adobe InDesign. The Clipboard is particularly useful for importing paths because paths are copied to the Clipboard as PostScript language descriptions. Artwork copied to the Clipboard is pasted in PICT format in most applications. However, some applications take the PDF version (such as InDesign) or the AICB version. PDF preserves transparency; AICB lets you specify whether you want to preserve the overall appearance of the selection or copy the selection as a set of paths (which can be useful in Photoshop).

To specify copying preferences, choose Edit > Preferences > File Handling & Clipboard (Windows) or Illustrator > Preferences > File Handling & Clipboard (Mac OS). Select PDF, AICB, or both. If you select AICB, select Preserve Paths to discard any transparency in the copied artwork or Preserve Appearance And Overprints to flatten any transparency, maintain the copied artwork’s appearance, and preserve overprinted objects.

Drag and drop artwork into a Photoshop document

- 1 Select the artwork you want to copy.
- 2 Open the Photoshop document into which you want to copy the selection.
- 3 Do one of the following:
 - To copy the artwork into Photoshop as bitmap images, drag the selection toward the Photoshop window, and when a black outline appears, release the mouse button. To position the selection in the center of the Photoshop image, hold down Shift before dragging the selection. By default, selected objects are copied as bitmap images to the active layer.

- To copy vector artwork into Photoshop as paths, hold down Ctrl (Windows) or Command (Mac OS), and drag the selection to the Photoshop document. When you release the mouse button, the selection becomes a Photoshop path.

Drag and drop artwork from Photoshop into Illustrator

- 1 Open the Photoshop document from which you want to copy.
- 2 Select the artwork you want to copy.
- 3 Select the Move tool  and drag the selection from Photoshop into the Illustrator file.

Drag and drop artwork to the desktop (Mac OS only)

- 1 Select the artwork you want to copy.
- 2 Drag the selection onto the desktop.

Selections are copied to the desktop as a picture clipping, which can be dragged and dropped into the desired document. Picture clippings are converted to PICT format when dragged to the desktop.

Offset duplicate objects

You can create a replica of an object, set off from the selected object by a specified distance, by using the Offset Path command or Offset Path effect. Offsetting objects is useful when you want to create concentric shapes or make many replications of an object with regular distances between each replication.

You can offset an object's path relative to its original path by using the Offset Path effect in the Effect menu. This effect is useful for converting a mesh object into a regular path. For example, if you have released an envelope, or want to convert a mesh shape for use in another application, apply the offset path command with an offset value of 0, and then delete the mesh shape. You can then edit the remaining path.

More Help topics

[“About effects”](#) on page 367

[“Stroke an object”](#) on page 151

Offset objects using the Offset Path command

- 1 Select one or more objects.
- 2 Choose Object > Path > Offset Path.
- 3 Specify the offset distance, line join type, and miter limit.
- 4 Click OK.

Offset objects using the Offset Path effect

- 1 Select one or more objects.
- 2 Choose Effect > Path > Offset Path.
- 3 Specify the offset distance, line join type, and miter limit.
- 4 Click OK.

Offset objects using keyboard

- 1 Select one or more objects.
- 2 Hold down Alt and press an arrow key.

A duplicate object is created, and is offset by the Keyboard Increment value specified in the General preferences. The location of the new object is determined by the arrow key you used.

Note: If a duplicate is not created, make sure that the Keyboard Increment preference is set to a value other than zero.

Chapter 7: Reshaping objects

Transforming objects

Transforming

Transforming encompasses moving, rotating, reflecting, scaling, and shearing objects. You can transform objects using the Transform panel, Object > Transform commands, and specialized tools. You can also perform many types of transformations by dragging the bounding box for a selection.

Sometimes you may want to repeat the same transformation several times, especially when you are copying objects. The Transform Again command in the Object menu lets you repeat a move, scale, rotate, reflect, or shear operation as many times as you want, until you perform a different transform operation.



Use the Info panel to view the current dimensions and position of your selection as you transform it.

For a video on scaling, skewing, and rotating objects, see www.adobe.com/go/vid0040.

More Help topics

[“Transform panel overview”](#) on page 230

[“Scale objects”](#) on page 232

[“Shear objects”](#) on page 234

[“Move objects”](#) on page 211

[“Rotate objects”](#) on page 216

[“Reflect or flip objects”](#) on page 218

Transform panel overview

The Transform panel (Window > Transform) displays information about the location, size, and orientation of one or more selected objects. By typing new values, you can modify the selected objects, their pattern fills, or both. You can also change the transformation reference point and lock the object’s proportions.

All values in the panel refer to the bounding boxes of the objects except for the X and Y values, which refer to the selected reference point. To pixel-align individual objects to pixel grid, check the Align to Pixel Grid check box.

Note: *The reference point locator in the Transform panel specifies an object’s reference point only when you transform the object by changing the values in the panel. Other methods of transforming (such as using the Scale tool) use the object’s center point or the pointer location as the reference point.*

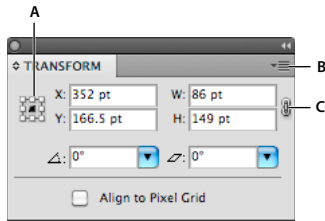

Transform panel
A. Reference point locator B. Panel menu C. Lock proportions icon

Transform an object's patterns

When you move, rotate, reflect (flip), scale, or shear an object that is filled with a pattern, you can transform just the object, just the pattern, or both the object and pattern. Once you transform an object's fill pattern, all patterns that you subsequently apply to that object are transformed the same way.

- To specify how you want to transform patterns when using the Transform panel, select an option from the panel menu: Transform Object Only, Transform Pattern Only, or Transform Both.
- To specify how you want to transform patterns when using a transform command, set the Objects and Patterns options in the corresponding dialog box. For example, select Patterns and deselect Objects if you want to transform the pattern but not the object.
- To transform patterns but not objects when using a transform tool, hold down the tilde key (~) while dragging. The borders of the object appear to be transformed, but when you release the mouse button, the borders snap back to their original configuration, leaving only the pattern transformed.
- To prevent patterns from transforming when using transform tools, choose Edit > Preferences > General (Windows) or Illustrator > Preferences > General (Mac OS) and deselect Transform Pattern Tiles.
- To return an object's fill pattern to its original state, fill the object with a solid color, and then reselect the desired pattern.

Transform using the bounding box

When you select one or more objects with the Selection tool, a *bounding box* displays around them. Use the bounding box to easily move, rotate, duplicate, and scale objects by dragging the object or a handle (one of the hollow squares along the bounding box).

- To hide the bounding box, choose View > Hide Bounding Box.
- To show the bounding box, choose View > Show Bounding Box.
- To reorient the bounding box after you rotate it, choose Object > Transform > Reset Bounding Box.

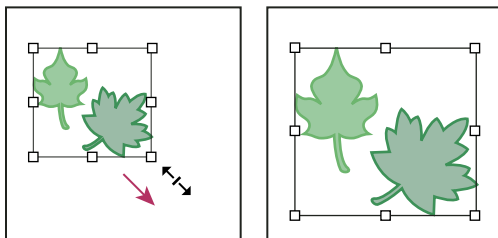

Selected objects before (left) compared to after (right) scaling using the bounding box

Scaling, shearing, and distorting objects

Scale objects

Scaling an object enlarges or reduces it horizontally (along the x axis), vertically (along the y axis), or both. Objects scale relative to a reference point which varies depending on the scaling method you choose. You can change the default reference point for most scaling methods, and you can also lock the proportions of an object.

Note: After you scale an object, Illustrator does not retain the original size of the object in memory. Therefore, you cannot resume the original size of the object. However, you can see the resolution of the object in the Document Info panel and decide on the scale at which you want to resize the object, while retaining the object's resolution.

By default, strokes and effects are not scaled along with objects. To scale strokes and effects, choose Edit > Preferences > General (Windows) or Illustrator > Preferences > General (Mac OS), and select Scale Strokes & Effects. If you want to choose whether to scale strokes and effects on a case-by-case basis, use the Transform panel or the Scale command to scale objects.

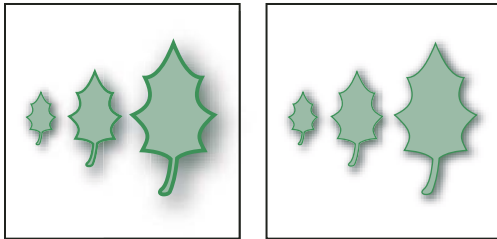

The Scale Strokes & Effects option scales the object, the drop shadow effect, and the stroke (left); only the object scales when this option is off (right).



More Help topics

[“Reshaping tool gallery”](#) on page 21

[“Transform using the bounding box”](#) on page 231

[“Transform panel overview”](#) on page 230

Scale objects with the Scale tool

- 1 Select one or more objects.
- 2 Select the Scale tool .
- 3 Do any of the following:
 - To scale relative to the object's center point, drag anywhere in the document window until the object is the desired size.
 - To scale relative to a different reference point , click where you want the reference point to be in the document window, move the pointer away from the reference point, and then drag until the object is the desired size.
 - To maintain the object's proportions as it scales, hold down Shift as you drag diagonally.

 While using the Scale tool with the Shift key, start dragging at an angle of 45° horizontally or vertically but in an angle.

- To scale the object along a single axis, hold down Shift as you drag vertically or horizontally.

 For finer control over scaling, start dragging farther from the reference point.

Scale objects with the bounding box

- 1 Select one or more objects.
- 2 Select the Selection tool or the Free Transform tool .
- 3 Drag a bounding box handle until the object is the desired size.



Objects scale relative to the opposite handle of the bounding box.

- 4 Do any of the following to control the scaling behavior:
 - To maintain the object's proportions, hold down Shift as you drag.
 - To scale relative to the object's center point, hold down Alt (Windows) or Option (Mac OS) as you drag.

Scale objects to a specific width and height

- 1 Select one or more objects.
- 2 In the Transform panel, enter a new value in the Width (W) or Height (H) box, or both.

You can do any of the following before you enter a value to control the scaling behavior:

- To maintain the objects' proportions, click the lock proportions button .
- To change the reference point for scaling, click a white square on the reference point locator .
- To scale stroked paths and any size-related effects along with the object, select Scale Strokes & Effects from the panel menu.

 You can also maintain proportions by entering a value in the W or H box, and then pressing Ctrl (Windows) or Command (Mac OS) while you press Enter.

Scale objects by a specific percentage

- 1 Select one or more objects.
- 2 Do one of the following:
 - To scale from the center, choose Object > Transform > Scale or double-click the Scale tool .
 - To scale relative to a different reference point, select the Scale tool and Alt-click (Windows) or Option-click (Mac OS) where you want the reference point to be in the document window.
- 3 In the Scale dialog box, do one of the following:
 - To maintain the object's proportions as it scales, select Uniform, and enter a percentage in the Scale text box.
 - To scale the height and width separately, select Non-Uniform, and enter a percentage in the Horizontal and Vertical text boxes.

The scale factors are relative to the reference point and can be negative or positive.

- 4 To scale stroked paths and any size-related effects along with the object, select Scale Strokes & Effects.
- 5 If the objects contain a pattern fill, select Patterns to scale the pattern. Deselect Objects if you want to scale the pattern but not the objects.
- 6 Click OK, or click Copy to scale a copy of the objects.

Scale multiple objects

- 1 Select the objects.
- 2 Choose Object > Transform > Transform Each.

Note: You cannot enter a specific width for scaling multiple objects. In Illustrator, you can only scale objects in percentage measurements.

- 3 Set percentages for horizontal and vertical scaling in the Scale section of the dialog box.
- 4 To change the reference point, click a white square on the reference point locator .
- 5 Click OK, or click Copy to scale a copy of each object.

Shear objects

Shearing an object slants, or skews, the object along the horizontal or vertical axis, or a specified angle that's relative to a specified axis. Objects shear relative to a reference point which varies depending on the shearing method you choose and can be changed for most shearing methods. You can lock one dimension of an object as you shear it, and you can shear one object or multiple objects simultaneously.

 *Shearing is useful for creating cast shadows.*

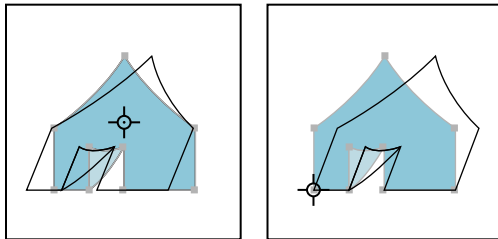



Shearing relative to the center (left) compared to shearing relative to a user-defined reference point (right)

More Help topics

[“Reshaping tool gallery”](#) on page 21

[“Transform panel overview”](#) on page 230

Shear objects with the Shear tool

- 1 Select one or more objects.
- 2 Select the Shear tool .
- 3 Do one of the following:
 - To shear relative to the object's center, drag anywhere in the document window.
 - To shear relative to a different reference point , click anywhere in the document window to move the reference point, move the pointer away from the reference point, and then drag until the object is at the desired slant.
 - To shear along the object's vertical axis, drag anywhere in the document window in an up or down direction. To constrain the object to its original width, hold down Shift.
 - To shear along the object's horizontal axis, drag anywhere in the document window in a left or right direction. To constrain the object to its original height, hold down Shift.

Shear objects with the Shear command

- 1 Select one or more objects.
- 2 Do one of the following:
 - To shear from the center, choose Object > Transform > Shear or double-click the Shear tool .

- To shear from a different reference point, select the Shear tool and Alt-click (Windows) or Option-click (Mac OS) where you want the reference point to be in the document window.
- 3 In the Shear dialog box, enter a shear angle from -359 to 359. The shear angle is the amount of slant applied to the object in a clockwise direction and is relative to a line that's perpendicular to the shear axis.
 - 4 Select the axis along which to shear the object.
- If you chose an angled axis, enter a value between -359 and 359, relative to the horizontal axis.
- 5 If the objects contain a pattern fill, select Patterns to move the pattern. Deselect Objects if you want to move the pattern but not the objects.
 - 6 Click OK, or click Copy to shear a copy of the objects.

Shear objects with the Free Transform tool

- 1 Select one or more objects.
- 2 Select the Free Transform tool .
- 3 Do one of the following:
 - To shear along the object's vertical axis, start dragging the middle-left or middle-right bounding-box handle, and then hold down Ctrl+Alt (Windows) or Option+Command (Mac OS) as you drag up or down. You can also hold down Shift to constrain the object to its original width.
 - To shear along the object's horizontal axis, start dragging the top-middle or bottom-middle bounding-box handle and then hold down Ctrl+Alt (Windows) or Option+Command (Mac OS) as you drag right or left. You can also hold down Shift to constrain the object to its original height.

Shear objects with the Transform panel

- 1 Select one or more objects.
- 2 In the Transform panel, enter a value in the Shear text box.

To change the reference point, click a white square on the reference point locator  before you enter the value.

 You can also call up the Transform panel by clicking X, Y, W, or H in the Control panel.

Distort objects

You can distort objects by using the Free Transform tool or a liquify tool. Use the Free Transform tool when you want to distort freely; use a liquify tool if you want to take advantage of specific preset distortions such as twirls, puckers, or wrinkles.

More Help topics

[“Transform using the bounding box”](#) on page 231

[“Reshaping objects with effects”](#) on page 254

[“Reshaping tool gallery”](#) on page 21

Distort objects with the Free Transform tool

- 1 Select one or more objects.
- 2 Select the Free Transform tool .

- 3 Start dragging a corner handle on the bounding box (not a side handle), and then do one of the following:
 - Hold down Ctrl (Windows) or Command (Mac OS) until the selection is at the desired level of distortion.
 - Hold down Shift+Alt+Ctrl (Windows) or Shift+Option+Command (Mac OS) to distort in perspective.

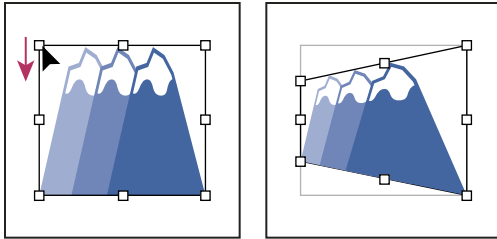

Distorting in perspective

Distort objects using a liquify tool

You cannot use liquify tools on linked files or objects that contain text, graphs, or symbols.

To find liquify tools in the Tools panel, see “[Tools panel overview](#)” on page 15 and “[Reshaping tool gallery](#)” on page 21.

- 1 Select a liquify tool, and click or drag over the objects you want to distort.
- 2 (Optional) To isolate the distortion to specific objects, select the objects before using the tool.
- 3 (Optional) To change the size of the tool cursor and set other tool options, double-click the liquify tool and specify any of the following:

Width and Height Controls the size of the tool cursor.

Angle Controls the orientation of the tool cursor.

Intensity Specifies the rate of change for the distortion. Higher values equal faster changes.

Use Pressure Pen Uses the input from a tablet or pen instead of the Intensity value. If you don't have a pressure-sensitive tablet attached, this option is dimmed.

Complexity (Scallop, Crystallize, and Wrinkle tools) Specifies how closely the results of the particular brush are spaced on the object's outline. This is closely tied with the Detail value.

Detail Specifies the spacing between points introduced into the object's outline (higher values space points closer together).

Simplify (Warp, Twirl, Pucker, and Bloat tools) Specifies how much you want to reduce the superfluous points that do not measurably affect the overall appearance of the shape.

Twirl Rate (Twirl tool only) Specifies the rate at which the twirl is applied. Enter a value between -180° and 180° . Negative values twirl the object clockwise and positive values twirl counterclockwise. The object twirls faster with values that are closer to either -180° or 180° . To twirl slowly, specify a rate close to 0° .

Horizontal and Vertical (Wrinkle tool only) Specifies how far apart the control points are placed.

Brush Affects Anchor Points, Brush Affects In Tangent Handles, or Brush Affects Out Tangent Handles (Scallop, Crystallize, Wrinkle tools) Enables the tool brush to make changes to these properties.

Reshape using envelopes

About envelopes

Envelopes are objects that distort or reshape selected objects. You can make an envelope out of an object on your artboard, or you can use a preset warp shape or a mesh grid as an envelope. You can use envelopes on any object except graphs, guides, or linked objects.

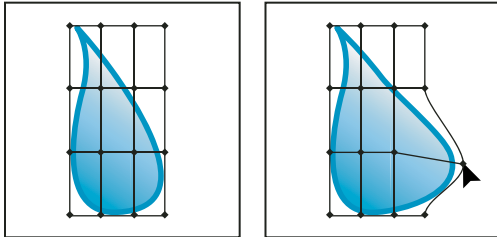

Mesh grid envelope



Envelope created from another object

The Layers panel lists envelopes as <Envelope>. Once you apply an envelope, you can continue to edit the original objects. You can also edit, delete, or expand an envelope at any time. You can edit an envelope shape or the enveloped object, but not both at the same time.

Distort objects using an envelope

- 1 Select one or more objects.
- 2 Create the envelope using one of the following methods:
 - To use a preset warp shape for the envelope, choose Object > Envelope Distort > Make With Warp. In the Warp Options dialog box, select a warp style and set options.
 - To set up a rectangular grid for the envelope, choose Object > Envelope Distort > Make With Mesh. In the Envelope Mesh dialog box, set the number of rows and columns.
 - To use an object as the shape of the envelope, make sure the object is at the top of the stacking order for the selected object. If it's not, use the Layers panel or an Arrange command to move it up, and reselect all the objects. Then choose Object > Envelope Distort > Make With Top Object.
- 3 Reshape the envelope by doing any of the following:
 - Drag any anchor point on the envelope with the Direct Selection or Mesh tool.
 - To delete anchor points on the mesh grid, select an anchor point with either the Direct Selection or Mesh tools, and then press Delete.
 - To add anchor points to the mesh grid, click on the grid with the Mesh tool.

 To apply a stroke or fill to an envelope, use the Appearance panel.

More Help topics

[“Reshaping objects with effects”](#) on page 254

[“Envelope options”](#) on page 239

Edit the contents of an envelope

1 Select the envelope and do one of the following:

- Click the Edit Contents button  in the Control panel.
- Choose Object > Envelope Distort > Edit Contents.

Note: If your envelope consists of grouped paths, click the triangle to the left of the <Envelope> entry in the Layers panel to view and target the path you want to edit.

2 Edit it as desired.

Note: When you modify the contents of an envelope, the envelope shifts to recenter the results with the original content.

3 To return the object to its enveloped state, do one of the following:

- Click the Edit Envelope button  in the Control panel.
- Choose Object > Envelope Distort > Edit Envelope.

More Help topics

[“Envelope options”](#) on page 239

Reset an envelope

1 Select the envelope.

2 Do one of the following:

- To reset or switch to a preset warp style, choose a new warp style and set options in the Control panel. If desired, click the Envelope Options button  to open the dialog box and set more options.
- To reset or switch to a mesh grid envelope, choose Object > Envelope Distort > Reset With Mesh. Specify the number of rows and columns for the mesh grid. Select Maintain Envelope Shape to keep the warp shape intact.

Remove an envelope

You can remove envelopes by either releasing them or expanding them. Releasing an enveloped object creates two separate objects: the object in its original state and the envelope shape. Expanding an enveloped object removes the envelope, but the object retains its distorted shape.

- To release an envelope, select the envelope, and choose Object > Envelope Distort > Release.
- To expand an envelope, select the envelope, and choose Object > Envelope Distort > Expand.

Envelope options

Envelope options determine how art is distorted to fit the envelope. To set envelope options, select the envelope object and click the Envelope Options button  in the Control panel, or choose Object > Envelope Distort > Envelope Options.

Anti-Alias Smooths rasters when distorted with an envelope. Deselecting Anti-Alias can decrease the time it takes to distort rasters.

Preserve Shape Using Specifies how rasters preserve their shape when distorted by nonrectangular envelopes. Select Clipping Mask to use a clipping mask on the raster, or Transparency to apply an alpha channel to the raster.

Fidelity Specifies how precisely you want the object to fit the envelope mold. Increasing the Fidelity percentage can add more points to the distorted paths and increase the time it takes to distort the objects.

Distort Appearance Distorts appearance attributes (such as applied effects or graphic styles) along with an object's shape.

Distort Linear Gradients Distorts linear gradients along with an object's shape.

Distort Pattern Fills Distorts patterns along with an object's shape.

Note: If you expand the envelope with a Distort option selected, the respective property is expanded separately.

Combining objects

Methods of combining objects

You can combine vector objects to create shapes in a variety of ways in Illustrator. The resulting paths or shapes differ depending on the method you use to combine the paths.

Pathfinder effects

Pathfinder effects let you combine multiple objects using one of ten interaction modes. Unlike compound shapes, you can't edit the interactions between objects when you use a Pathfinder effect.

Compound shapes

Compound shapes let you combine multiple objects and specify how you want each object to interact with the other objects. Compound shapes are more versatile than compound paths because they provide four kinds of interactions: add, subtract, intersect, and exclude. In addition, the underlying objects are not changed, so you can select each object within a compound shape to edit it or change its interaction mode.

Compound paths

Compound paths let you use an object to cut a hole in another object. For example, you can create a doughnut shape from two nested circles. Once you create a compound path, the paths act as grouped objects. You can select and manipulate the objects separately using the Direct Selection tool or Group Selection tool; or you can select and edit the combined path.

Note: You can also add to an object by using the Blob Brush tool. When you use this brush, paths you paint are added to adjacent paths that use identical fill attributes. (See “[Draw and merge paths with the Blob Brush tool](#)” on page 155 and “[Building new shapes using the Shape Builder tool](#)” on page 255.)

Pathfinder panel overview

You use the Pathfinder panel (Window > Pathfinder) to combine objects into new shapes.

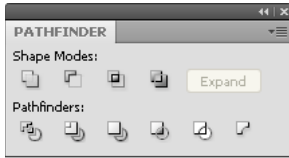

Pathfinder panel

The top row of buttons in the panel, make paths or compound paths by default, and compound shapes only when you press the Alt or Option key. You can choose from the following shape modes:

Add To Shape Area Adds the area of the component to the underlying geometry.

Subtract from Shape Area Cuts out the area of the component from the underlying geometry.

Intersect Shape Areas Uses the area of the component to clip the underlying geometry as a mask would.

Exclude Overlapping Shape Areas Uses the area of the component to invert the underlying geometry, turning filled regions into holes and vice versa.

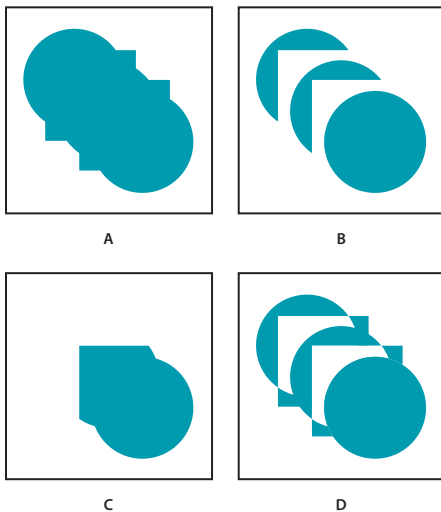

Shape modes

A. All components in Add mode B. Subtract mode applied to squares C. Intersect mode applied to squares D. Exclude mode applied to squares

The bottom row of buttons in the panel, called Pathfinder effects, let you create final shape combinations on the first click. (See “[Apply Pathfinder effects](#)” on page 241.)

Pathfinder options

You can set Pathfinder Options from the Pathfinder panel menu or by double-clicking a Pathfinder effect in the Appearance panel.

Precision Affects how precisely the Pathfinder effects calculate an object’s path. The more precise the calculation, the more accurate the drawing and the more time is required to generate the resulting path.

Remove Redundant Points Removes unnecessary points as you click a Pathfinder button.

Divide And Outline Will Remove Unpainted Artwork Deletes any unfilled objects in the selected artwork as you click the Divide or Outline button.

Apply Pathfinder effects

Pathfinder effects let you create new shapes out of overlapping objects. You can apply Pathfinder effects by using the Effects menu or the Pathfinder panel.

- Pathfinder effects in the Effects menu can only be applied to groups, layers, and text objects. After you apply the effect, you can still select and edit the original objects. You can also use the Appearance panel to modify or remove the effect.
- Pathfinder effects in the Pathfinder panel can be applied to any combination of objects, groups, and layers. The final shape combination is created when you click a pathfinder button; after that, you cannot edit the original objects. If the effect results in multiple objects, they are automatically grouped together.

For a video on using Pathfinder effects and clipping masks and how to import clipping masks into Flash, see www.adobe.com/go/vid0057.

More Help topics

[“Methods of combining objects”](#) on page 239

[“Group or ungroup objects”](#) on page 210

[“Move an object to a different layer”](#) on page 222

[“Targeting items for appearance attributes”](#) on page 363

[“Building new shapes using the Shape Builder tool”](#) on page 255

Apply a Pathfinder effect using the Effects menu

1 Do one of the following:

- Group together the objects you want to use, and select the group.
- Move the objects you want to use into a separate layer, and target the layer.

2 Choose Effect > Pathfinder and choose a Pathfinder effect.

 *To quickly apply the same Pathfinder effect again, choose Effect > Apply [effect].*

Apply a Pathfinder effect using the Pathfinder panel

1 Select the objects to which you want to apply the effect.

To apply a Pathfinder effect to a group or layer, target the group or layer.

2 In the Pathfinder panel, click a pathfinder button (in the bottom row), or Alt-click (Windows) or Option-click (Mac OS) a Shape Mode button (in the top row).

Summary of Pathfinder effects

Add Traces the outline of all objects as if they were a single, merged object. The resulting shape takes on the paint attributes of the top object.

Intersect Traces the outline of the region overlapped by all the objects.

Exclude Traces all nonoverlapping areas of the objects, and makes overlapping areas transparent. Where an even number of objects overlap, the overlap becomes transparent. Where an odd number of objects overlap, the overlap becomes filled.

Subtract Subtracts the frontmost objects from the backmost object. You can use this command to delete areas of an illustration by adjusting the stacking order.

Minus Back Subtracts the objects in back from the frontmost object. You can use this command to delete areas of an illustration by adjusting the stacking order.

Divide Separates a piece of artwork into its component filled faces (a *face* is an area undivided by a line segment).

Note: When you use the *Divide* button in the *Pathfinder* panel, you can use the *Direct Selection* or *Group Selection* tool to manipulate the resulting faces independently of each other. You can also choose to delete or preserve unfilled objects when applying the *Divide* command.

Trim Removes the part of a filled object that is hidden. It removes any strokes and does not merge objects of the same color.

Merge Removes the part of a filled object that is hidden. It removes any strokes and merges any adjoining or overlapping objects filled with the same color.

Crop Divides artwork into its component filled faces, and then deletes all the parts of the artwork that fall outside the boundary of the topmost object. It also removes any strokes.

Outline Divides an object into its component line segments, or *edges*. This command is useful for preparing artwork that needs a trap for overprinting objects. (See “[Create a trap](#)” on page 440.)

Note: When you use the *Outline* button in the *Pathfinder* panel, you can use the *Direct Selection* or *Group Selection* tool to manipulate each edge independently. You can also choose to delete or preserve unfilled objects when applying the *Outline* command.

Hard Mix Combines colors by choosing the highest value of each of the color components. For example, if Color 1 is 20% cyan, 66% magenta, 40% yellow, and 0% black; and Color 2 is 40% cyan, 20% magenta, 30% yellow, and 10% black, the resulting hard color is 40% cyan, 66% magenta, 40% yellow, and 10% black.

Soft Mix Makes the underlying colors visible through the overlapping artwork, and then divides the image into its component faces. You specify the percentage of visibility you want in the overlapping colors.

Trap Compensates for potential gaps between colors in artwork by creating a small area of overlap (called a trap) between two adjoining colors.

More Help topics

“[Mix overlapping colors](#)” on page 148

“[Trapping](#)” on page 440

About compound shapes

A *compound shape* is editable art consisting of two or more objects, each assigned a shape mode. Compound shapes make it easy to create complex shapes because you can precisely manipulate the shape mode, stacking order, shape, location, and appearance of each path included.

Compound shapes act as grouped objects and appear as <Compound Shape> items in the Layers panel. You can use the Layers panel to show, select, and manipulate the contents of a compound shape—for example, to change the stacking order of its components. You can also use the Direct Selection tool or the Group Selection tool to select components of a compound shape.

When you create a compound shape, it takes on the paint and transparency attributes of the topmost component in Add, Intersect, or Exclude mode. Subsequently, you can change the paint, style, or transparency attributes of the compound shape. Illustrator facilitates this process by automatically targeting the whole compound shape when you select any part of it, unless you explicitly target a component in the Layers panel.

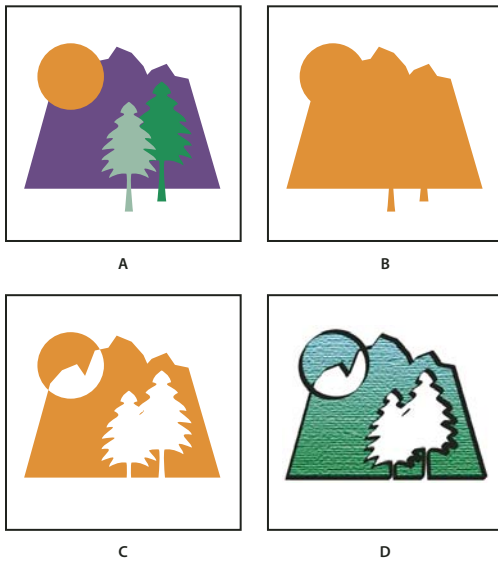

Working with compound shapes

A. Original objects B. Compound shape created C. Individual shape modes applied to each component D. Style applied to entire compound shape

Work with compound shapes

Creating a compound shape is a two-part process. First, you establish a compound shape in which all components have the same shape mode. Then, you assign shape modes to the components until you obtain the desired combination of shape areas.

Create a compound shape

1 Select all the objects you want to be part of the compound shape.

You can include paths, compound paths, groups, other compound shapes, blends, text, envelopes, and warps in a compound shape. Any open paths you select are automatically closed.

2 Do one of the following:

- In the Pathfinder panel, Alt-click (Windows) or Option-click (Mac OS) a Shape Modes button. Each component of the compound shape is assigned the shape mode you select.
- Select Make Compound Shape from the Pathfinder panel menu. Each component of the compound shape is assigned the Add mode by default.

3 Change the shape mode of any component by selecting it with the Direct Selection tool or Layers panel and clicking a Shape Mode button.

Note that you never need to change the mode of the backmost component, because its mode is not relevant to the compound shape.

 *To sustain maximum performance, create complex compound shapes by nesting other compound shapes (containing up to about 10 components each) instead of using many individual components.*

Modify a compound shape

- 1 Use the Direct Selection tool or Layers panel to select an individual component of the compound shape.
- 2 Look for the highlighted Shape Mode button in the Pathfinder panel to identify which mode is currently applied to a selected component.

Note: If you've selected two or more components that use different modes, question marks appear on the Shape Mode buttons.

- 3 In the Pathfinder panel, click a different Shape Mode button.

Release and expand a compound shape

Releasing a compound shape separates it back into separate objects. Expanding a compound shape maintains the shape of the compound object, but you can no longer select the individual components.

- 1 Select the compound shape using the Selection tool or Layers panel.
- 2 Do one of the following:
 - Click Expand in the Pathfinder panel.
 - Choose Expand Compound Shape from the Pathfinder panel menu.

The compound shape is converted to a <Path> or <Compound Path> item in the Layers panel, depending on the shape mode it used.

- Choose Release Compound Shape from the Pathfinder panel menu.

Move compound shapes between Illustrator and Photoshop

The shape layers and layer clipping paths (vector masks) in Adobe Photoshop are types of compound shapes. You can import shape layers and layer clipping paths into Illustrator as compound shapes and continue to manipulate them. In addition, you can export compound shapes to Photoshop. Keep the following in mind when using compound shapes with Photoshop:

- Only compound shapes that reside at the top level of the layer hierarchy are exported to Photoshop as shape layers.
- A compound shape painted with a stroke using a join other than round, or with a weight in points that is not an integer, is rasterized when exported to the PSD file format.

About compound paths

A *compound path* contains two or more paths that are painted so that holes appear where paths overlap. When you define objects as a compound path, all objects in the compound path take on the paint and style attributes of the backmost object in the stacking order.

Compound paths act as grouped objects and appear as <Compound Path> items in the Layers panel. Use the Direct Selection tool or the Group Selection tool to select part of a compound path. You can manipulate the shape of individual components of a compound path, but you cannot change appearance attributes, graphic styles, or effects for individual components, and you cannot manipulate components individually in the Layers panel.



If you want more flexibility in the compound path creation, you can create a compound shape and then expand it.

Cut a hole in an object using a compound path

- 1 Select the object to use as a hole, and position it so that it overlaps the object to cut. Repeat for any additional objects you want to use as holes.

- 2 Select all the objects you want to include in the compound path.
- 3 Choose Object > Compound Path > Make.

Apply fill rules to compound paths

You can specify whether a compound path is a nonzero winding path or an even-odd path.

Nonzero winding fill rule Uses mathematical equations to determine if a point is outside or inside a shape. Illustrator uses the nonzero winding rule as the default rule.

Even-odd fill rule Uses mathematical equations to determine if a point is outside or inside a shape. This rule is the more predictable rule because every other region within an even-odd compound path is a hole, regardless of path direction. Some applications, such as Adobe Photoshop, use the even-odd rule by default, so compound paths imported from these applications will use the even-odd rule.

Self-intersecting paths are paths that intersect themselves. You can choose to make these paths either nonzero winding or even-odd, depending on how you want them to look.

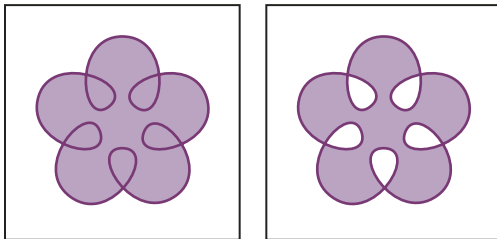

Self-intersecting path with Use Non-Zero Winding Fill Rule (left) compared with Use Even-Odd Fill Rule (right)

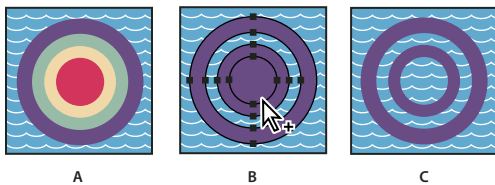

When you create a nonzero winding compound path, you can specify whether overlapping paths appear with holes or are filled by clicking a Reverse Path Direction button in the Attributes panel.





Fill rules

A. Four circular paths B. Circular paths selected, converted into compound path C. Reverse Path Direction applied to innermost path

Change the fill rule for a compound path

- 1 Select the compound path using the Selection tool or Layers panel.
- 2 In the Attributes panel, click the Use Non-Zero Winding Fill Rule button  or the Use Even-Odd Fill Rule button .

Change a hole in a compound path to a filled area

- 1 Make sure that the compound path uses the nonzero winding fill rule.
- 2 With the Direct Selection tool, select the part of the compound path to reverse. Do not select the entire compound path.
- 3 In the Attributes panel, click the Reverse Path Direction Off button  or the Reverse Path Direction On button .

Return a compound path to its original components

- 1 Select the compound path using the Selection tool or Layers panel.
- 2 Choose Object > Compound Path > Release.

Cutting and dividing objects

Methods for cutting, dividing, and trimming objects

Illustrator provides the following methods to cut, divide, and trim objects:

Divide Objects Below command Acts as a cookie cutter or stencil, using a selected object to cut through other objects, discarding the original selection. To use this command, choose Object > Path > Divide Objects Below.

Cut Path At Selected Anchor Point button  Cuts a path at the anchor point and the one anchor point becomes two anchor points with one located directly on top of the other. To access this button, select one or more anchor points with the Direct Selection tool and locate the button in the Control panel.

Knife tool  Cuts objects along a freehand path you draw with the tool, dividing objects into their component filled faces (a *face* is an area undivided by a line segment).

Scissors tool  Splits a path, graphics frame, or empty text frame at an anchor point or along a segment.

Split Into Grid command Lets you divide one or more objects into multiple rectangular objects arranged in rows and columns. You can precisely change the height, width, and gutter size between rows and columns, and quickly create guides for laying out artwork. To use this command, choose Object > Path > Split Into Grid.

Compound paths and compound shapes Let you use an object to cut a hole in another object.

Pathfinder effects Provide various ways to divide and trim overlapping objects.

Clipping masks Let you use an object to hide portions of other objects.

More Help topics

[“About clipping masks”](#) on page 247

[“About compound shapes”](#) on page 242

[“About compound paths”](#) on page 244

[“Cut a hole in an object using a compound path”](#) on page 244

[“Apply Pathfinder effects”](#) on page 241

[“Split a path”](#) on page 77

Cut objects with the Divide Objects Below command

- 1 Select the object to use as a cutter, and position it so that it overlaps the objects to cut.
- 2 Choose Object > Path > Divide Objects Below.

Cut objects with the Knife tool

- 1 Select the Knife tool .

2 Do one of the following:

- To cut in a curved path, drag the pointer over the object.
- To cut in a straight path, hold down Alt (Windows) or Option (Mac OS) as you click on the artboard with the Knife tool, and then drag.

More Help topics

[“Slicing and cutting tool gallery”](#) on page 24

Divide an object into a grid

1 Select the object.

If you select more than one object, the resulting grid of objects uses the appearance attributes of the topmost object.

2 Choose Object > Path > Split Into Grid.

3 Enter the number of rows and columns you want.

4 (Optional) Do any of the following:

- To set the size of each row and column, enter values for Height and Width.
- To set the amount of space that separates rows from one another and columns from one another, enter values for Gutter.
- To change the dimensions of the entire grid of objects, enter values for Total.
- To add guides along the row and column edges, select Add Guides.

5 Click OK.

More Help topics

[“Draw grids”](#) on page 57

Clipping masks

About clipping masks

A *clipping mask* is an object whose shape masks other artwork so that only areas that lie within the shape are visible—in effect, clipping the artwork to the shape of the mask. The clipping mask and the objects that are masked are called a *clipping set*. You can make a clipping set from a selection of two or more objects or from all objects in a group or layer.

Object-level clipping sets are combined as a group in the Layers panel. If you create layer-level clipping sets, the object on top of the layer clips all of the objects below it. All operations that you perform on an object-level clipping set, such as transformations and alignment, are based on the clipping mask’s boundary, not the unmasked boundary. Once you have created an object-level clipping mask, you can only select the clipped content by using the Layers panel, the Direct Selection tool, or by isolating the clipping set.

For a video on using Pathfinder effects and clipping masks and how to import clipping masks into Flash, see www.adobe.com/go/vid0057.

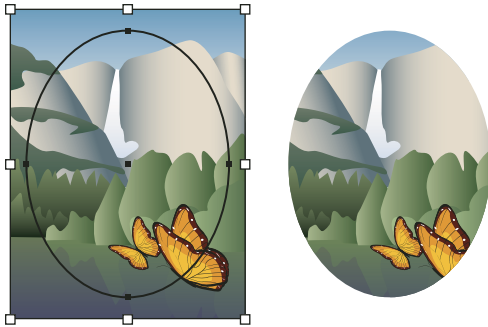

Before masking (left) compared to after masking (right)

The following guidelines apply to creating clipping masks:

- The objects that you mask are moved into the clipping mask's group in the Layers panel if they don't already reside there.
- Only vector objects can be clipping masks; however, any artwork can be masked.
- If you use a layer or group to create a clipping mask, the first object in the layer or group masks everything that is a subset of the layer or group.
- Regardless of its previous attributes, a clipping mask changes to an object with no fill or stroke.



To create a semitransparent mask, use the Transparency panel to create an opacity mask.

For more information on using masks and transparency, see www.adobe.com/go/learn_ai_tutorials_mask_en.

More Help topics

Using masks

“Isolate artwork for editing” on page 202

“Methods for cutting, dividing, and trimming objects” on page 246

“Use opacity masks to create transparency” on page 182

“Draw Behind mode” on page 54

“Draw Inside mode” on page 54

Hide parts of objects with a clipping mask

1 Create the object you want to use as the mask.

This object is called the *clipping path*. Only vector objects can be clipping paths.

2 Move the clipping path above the objects you want to mask in the stacking order.

3 Select the clipping path and the objects you want to mask.

4 Choose Object > Clipping Mask > Make.



To create a clipping path from the area where two or more objects overlap, group the objects first.

More Help topics

[“Stacking objects”](#) on page 225

Create a clipping mask for a group or layer

- 1 Create the object you want to use as the mask.

This object is called the *clipping path*. Only vector objects can be clipping paths.

- 2 Move the clipping path and the objects you want to mask into a layer or group.
- 3 In the Layers panel, make sure that the masking object is at the top of the group or layer, and then click the name of the layer or group.
- 4 Click the Make/Release Clipping Masks button at the bottom of the Layers panel or select Make Clipping Mask from the Layers panel menu.

More Help topics

[“Layers panel overview”](#) on page 220

[“Stacking objects”](#) on page 225

Edit a clipping mask

- 1 In the Layers panel, select and target the clipping path. Or, select the clipping set and choose Object > Clipping Mask > Edit Mask.
- 2 Do any of the following:
 - Move the clipping path by dragging the object’s center reference point with the Direct Selection tool.
 - Reshape the clipping path using the Direct Selection tool.
 - Apply a fill and stroke to a clipping path.



To select all clipping paths in a document, deselect all artwork. Then choose Select > Object > Clipping Masks.

More Help topics

[“Layers panel overview”](#) on page 220

Edit paths within a clipping set

To edit portions of a path that fall outside of the clipping mask, you must first select the specific path within in the clipping mask boundary, and then edit the path.

- 1 Do one of the following:
 - Target the path in the Layers panel.
 - Position the Direct Selection tool over a portion of the path that appears within the mask. When the path’s outline appears, click it.

Note: *To select a clipped path by clicking it, you must click the portion of it that appears inside the mask.*

- 2 Edit the path.

Add or remove an object from masked artwork

- ❖ In the Layers panel, drag the object into or out of the group or layer that contains the clipping path.

More Help topics

[“Layers panel overview”](#) on page 220

Release objects from a clipping mask

- ❖ Do one of the following:
 - Select the group that contains the clipping mask, and choose Object > Clipping Mask > Release.
 - In the Layers panel, click the name of the group or layer that contains the clipping mask. Click the Make/Release Clipping Masks button at the bottom of the panel, or select Release Clipping Mask from the panel menu.

Because the clipping mask was assigned a fill and stroke value of None, it is now not visible unless you select it or assign it new paint attributes.

More Help topics

[“Layers panel overview”](#) on page 220

Blending objects

About blended objects

You can blend objects to create and distribute shapes evenly between two objects. You can also blend between two open paths to create a smooth transition between objects, or you can combine blends of colors and objects to create color transitions in the shape of a particular object.

Note: Blending objects is not the same as applying blending modes or transparency to objects. For information on blending modes and transparency, see [“About blending modes”](#) on page 186.

Once you create a blend, the blended objects are treated as one object. If you move one of the original objects, or edit the original object’s anchor points, the blend changes accordingly. In addition, the new objects blended between the original objects don’t have their own anchor points. You can expand the blend in order to divide the blend into distinct objects.

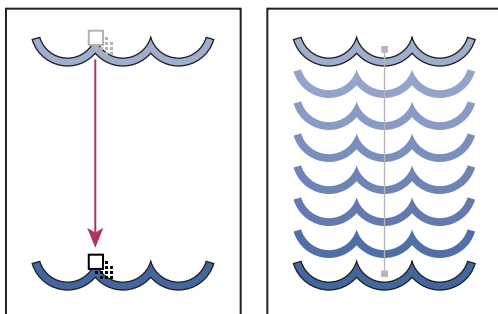

Example of using a blend to distribute shapes evenly between two objects

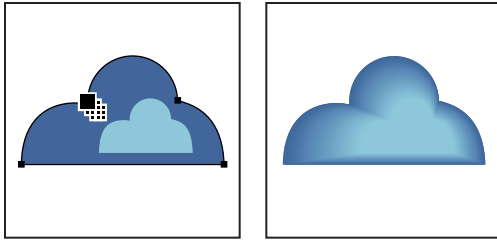

Example of using a blend to distribute color smoothly between two objects

The following rules apply to blended objects and their associated colors:

- You cannot blend between mesh objects.
- If you blend between one object painted with a process color and another object painted with a spot color, the blended shapes are painted with a blended process color. If you blend between two different spot colors, process colors are used to paint the intermediate steps. If, however, you blend between tints of the same spot color, the steps are all painted with percentages of the spot color.
- If you blend between two patterned objects, the blended steps will only use the fill of the object on the topmost layer.
- If you blend between objects that have blending modes specified with the Transparency panel, the blended steps will only use the blending mode of the top object.
- If you blend between objects with multiple appearance attributes (effects, fills, or strokes), Illustrator attempts to blend the options.
- If you blend between two instances of the same symbol, blended steps will be instances of that symbol. If, however, you blend between two instances of different symbols, the blended steps will not be symbol instances.
- By default, blends are created as knockout transparency groups, so that if any of the steps consist of overlapping transparent objects, these objects will not show through each other. You can change this setting by selecting the blend and deselecting Knockout Group in the Transparency panel.

Create blends

The Blend tool and Make Blend command let you create blends, which are a series of intermediate objects and colors between two or more selected objects.

Create a blend with the Blend tool

- 1 Select the Blend tool .
- 2 Do one of the following:
 - To blend in sequential order with no rotation, click anywhere on each object, but avoid anchor points.
 - To blend to a specific anchor point on an object, click the anchor point with the Blend tool. When the pointer is over an anchor point, the pointer changes from a white square to transparent with a black dot in its center.
 - To blend open paths, select an endpoint on each path.
- 3 When you are finished adding objects to the blend, click the Blend tool again.

 *By default, Illustrator calculates the optimum number of steps to create a smooth color transition. To control the number of steps or distance between steps, set blending options. (See “Blend options” on page 252.)*

Create a blend with the Make Blend command

- 1 Select the objects you want to blend.

2 Choose Object > Blend > Make.

 By default, Illustrator calculates the optimum number of steps to create a smooth color transition. To control the number of steps or distance between steps, set blending options.



Blend options

You set blending options by double-clicking the Blend tool  or choosing Object > Blend > Blend Options. To change options for an existing blend, select the blended object first.

Spacing Determines how many steps are added to the blend.

- **Smooth Color** Lets Illustrator auto-calculate the number of steps for the blends. If objects are filled or stroked with different colors, the steps are calculated to provide the optimum number of steps for a smooth color transition. If the objects contain identical colors, or if they contain gradients or patterns, the number of steps is based on the longest distance between the bounding box edges of the two objects.
- **Specified Steps** Controls the number of steps between the start and end of the blend.
- **Specified Distance** Controls the distance between the steps in the blend. The distance specified is measured from the edge of one object to the corresponding edge on the next object (for example, from the rightmost edge of one object to the rightmost edge of the next).

Orientation Determines the orientation of blended objects.

- **Align to Page**  Orients the blend perpendicular to the x axis of the page.
- **Align to Path**  Orients the blend perpendicular to the path.

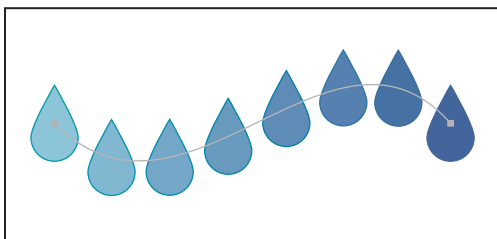

Align to Page option applied to a blend

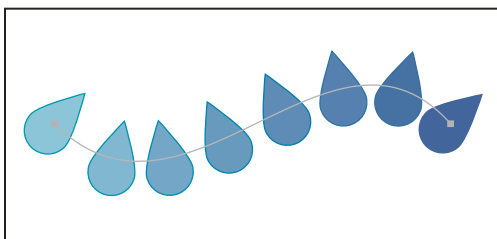

Align to Path option applied to a blend

Change the spine of a blended object

The *spine* is the path along which the steps in a blended object are aligned. By default, the spine forms a straight line.

- To adjust the shape of the spine, drag the anchor points and path segments on the spine with the Direct Selection tool.

- To replace the spine with a different path, draw an object to use as the new spine. Select the spine object and the blended object, and choose Object > Blend > Replace Spine.
- To reverse the order of a blend on its spine, select the blended object and choose Object > Blend > Reverse Spine.

More Help topics

[“Reshaping objects”](#) on page 230

Reverse the stacking order in a blended object

- 1 Select the blended object.
- 2 Choose Object > Blend > Reverse Front To Back.

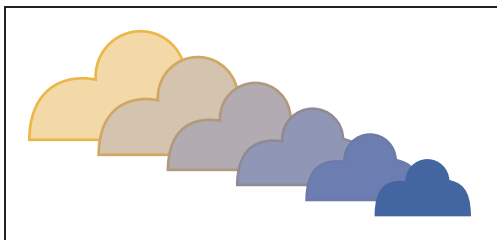
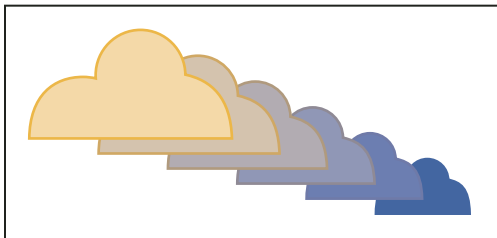

Original stacking order (top) compared to applying Reverse Front To Back command (bottom)

More Help topics

[“Stacking objects”](#) on page 225

Release or expand a blended object

Releasing a blended object removes the new objects and restores the original objects. Expanding a blended object divides the blend into distinct objects, which you can edit individually like any object.

- 1 Select the blended object.
- 2 Do one of the following:
 - Choose Object > Blend > Release.
 - Choose Object > Blend > Expand.

Reshaping objects with effects

Reshaping objects with effects

Using effects is a convenient way to reshape objects without making permanent changes to their underlying geometry. Effects are live, which means that you can modify or remove the effect at any time.

You can use the following effects to reshape objects:

Convert To Shape Converts the shape of vector objects to a rectangle, rounded rectangle, or ellipse. Set the dimensions of the shape using absolute or relative dimensions. For rounded rectangles, specify a corner radius to determine the curvature of the rounded edge.

Distort & Transform Lets you quickly reshape vector objects.

Free Distort Lets you change the shape of a vector object by dragging any of four corner points.

Pucker & Bloat Pulls a vector object's anchor points outward while curving the segments inward (Pucker) or inward while curving the segments outward (Bloat). Both options pull the anchor points relative to the object's center point.

Roughen Transforms a vector object's path segments into a jagged array of peaks and valleys of various sizes. Set the maximum length for segment paths using an absolute or relative size. Set the density of jagged edges per inch (Detail) and choose between soft edges (Smooth) or sharp edges (Corner).

Transform Reshapes an object by resizing, moving, rotating, reflecting (flipping), and copying it.

Tweak Randomly curves and distorts path segments inward and outward. Set the vertical and horizontal distortion using an absolute or relative amount. Specify whether or not to modify anchor points, move control points that lead into anchor points on the path ("In" Control Points), and move control points that lead out of anchor points on the path ("Out" Control Points).

Twist Rotates an object more sharply in the center than at the edges. Entering a positive value twists clockwise; entering a negative value twists counterclockwise.

Zig Zag Transforms an object's path segments into a jagged or wavy array of uniformly sized peaks and valleys. Set the length between peaks and valleys using an absolute or relative size. Set the number of ridges per path segment and choose between wavy edges (Smooth) or jagged edges (Corner).

Warp Distorts or deforms objects, including paths, text, meshes, blends, and bitmap images. Choose one of the predefined warp shapes. Then select which axis the bending option affects and specify the amount of bending and distortion to apply.

More Help topics

["About effects"](#) on page 367

["Apply an effect"](#) on page 367

["Modify or delete an effect"](#) on page 370

Round the corners of objects

The Round Corners effect converts the corner points of a vector object to smooth curves.

1 In the Layers panel, target the items you want to round.

If you want to round a specific attribute of an object, such as its fill or stroke, target the object in the Layers panel and then select the attribute in the Appearance panel.

- 2 Choose Effect > Stylize > Round Corners. (The command is located in the first Stylize submenu.)
- 3 To define the curvature of the rounded curve, enter a value in the Radius text box, and click OK.

More Help topics

[“About effects”](#) on page 367

[“Apply an effect”](#) on page 367

[“Modify or delete an effect”](#) on page 370

Building new shapes using the Shape Builder tool

About the Shape Builder Tool

The Shape Builder tool  is an interactive tool for creating complex shapes by merging and erasing simpler shapes. It works on simple and compound paths.

It intuitively highlights edges and regions of the selected art, which can be merged to form new shapes. An edge is defined as the section of a path, which does not intersect any other path of the selected objects. A region is a closed area bounded by edges.

By default, the tool is in merge mode where it allows you to combine paths or regions. You can also switch to the erase mode to delete any unwanted edges or regions by pressing Alt (Windows) or Option (Mac).

For a video on creating new shapes using the Shape Builder tool, see www.adobe.com/go/lrvid5203_ai_en.

Setting the Shape Builder tool options

You can set up and customize various options such as gap detection, coloring source, and highlighting to get the required merging capability and better visual feedback.

Double-click the Shape Builder Tool icon in the Tools panel to set these options in the Shape Builder Tool Options dialog box.

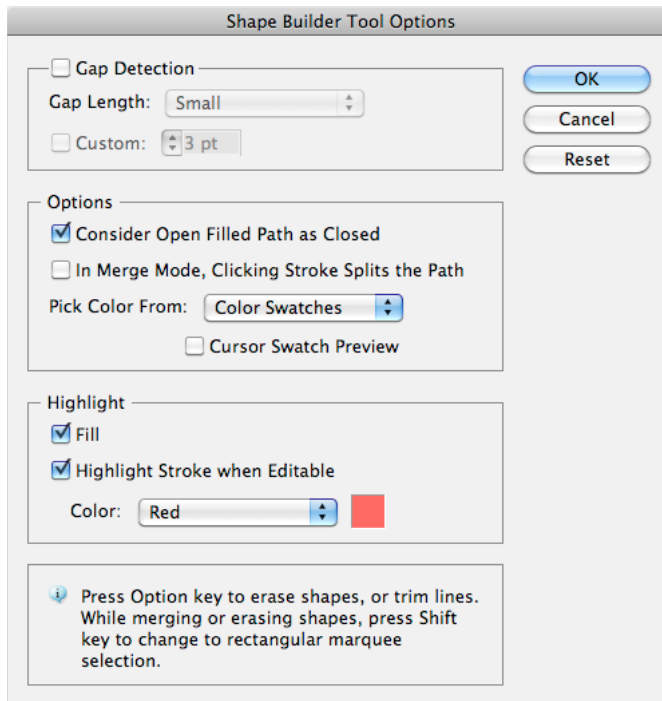

Shape Builder Tool Options dialog box

Gap Detection Set the gap length using the Gap Length drop-down list. The values available are Small (3 points), Medium (6 points), and Large (12 points).

Select the Custom check box if you want to provide an exact gap length.

When you select the gap length, Illustrator finds the gaps only close to the specified gap length value. Make sure that the gap length value is close (approximately) to the actual gap length of the art. You can check if the gaps are being detected by providing different gap length values until the gaps in the art are detected.

For example, if you set the gap length to 12 points, whereas the shape that you need to merge contains gaps at 3 points, Illustrator may not detect the gaps.

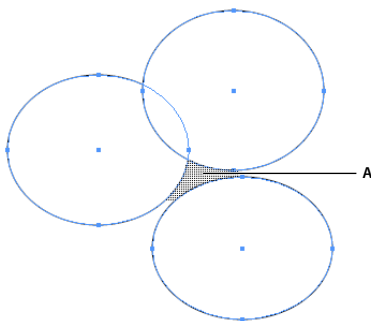

The highlighted area shows that the gap is detected and is considered as a region

Consider Open Filled Paths as Closed If this option is selected, an invisible edge is created for an open path to make a region. When you click inside the region, a shape is created.

In Merge Mode, Clicking the Stroke Splits the Path Select the check box, In Merge Mode, Clicking Stroke Splits the Path. This option allows you to split the parent path into two. The first path is created from the edge on which you

click and second path is the remaining portion of the parent path excluding the first path. If this option is selected, the pointer changes to , while splitting the path.

Pick Color From You can choose to color objects using the color swatches or the colors used in existing artwork. Use the Pick Color From drop-down list to select the Color Swatches or Artwork option.

If you select the Color Swatches option, you get the Cursor Swatch Preview option. You can select the Cursor Swatch Preview check box to preview and select colors. A Live Paint style cursor swatch is provided when you select this option. It allows iteration (using the arrow keys) and selecting colors from the swatches panel.

Note: You can iterate using the arrow keys even if the Cursor Swatch Preview is disabled.

To change the color of the stroke, move the pointer over object edges to highlight and change the color of the stroke. This option works only if the option, In Merge Mode, Clicking Stroke Splits the Path is selected.

You can select the fill color of a region by pointing anywhere on the document.

Note: The Cursor Swatch Preview is not displayed while merging, to ensure that the shapes are clearly visible.

If you select the Artwork option, Illustrator uses the same rules that are used for other art styles on merged objects. For more information, see step 6 in “[Creating shapes using Shape Builder Tool](#)” on page 257.

Fill The Fill check box is selected by default. If this option is selected, the path or region that you can merge, is highlighted in gray, when you mouse over the selected path. If this option is not selected, the selected region or path appears as normal.

Highlight Stroke When Editable If this option is selected, Illustrator highlights the strokes that you can edit. The editable stroke appears in the color that you choose from the Color drop-down list.

Creating shapes using Shape Builder Tool

To create a shape using the Shape Builder tool, do the following:

- 1 Create the shapes on which you want to apply the Shape Builder tool.
- 2 Using the Selection tool, select the paths that you need to merge to create the shape.

Important: Make sure that you select only those paths on which you need to apply the tool. If you select all the paths before merging, then there would be a performance overhead.

- 3 Select the Shape Builder tool from the Tools panel or press Shift+M. By default, the tool is in merge mode, where you can combine different paths. The pointer in this mode appears as .
- 4 Identify the region that you want to extract or merge.
- 5 To break or extract the region from the rest of the shape, move the pointer and click the selected region.

Additional anchor points are introduced where the shapes break up.

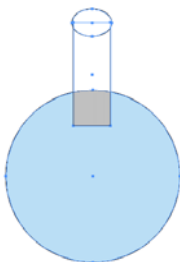

Merging closed regions using the Shape Builder tool. The marquee region appears when you move the pointer over a closed region.

- 6 To merge paths, drag along the region and release the mouse, the two regions get merged to form a new shape.

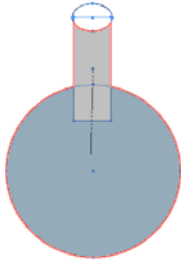

Drag along the region to merge

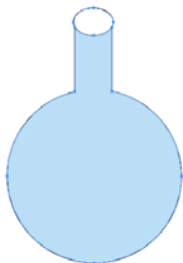

New shape after merging

The art style that the new shape inherits, depends on the following rules:

- The art style of the object from where the mouse drag was initiated is applied to the merging shapes.
- If no art style is available on mouse down, then the art style available on mouse release is applied to the merging shapes.
- If no art style is available on mouse down or mouse release, then the art style of the topmost selected object in the Layers panel, is applied.

For coloring, you can override these rules by selecting Color Swatches from the Pick Color From drop-down list in the Shape Builder Tool Options dialog box. For details, see “[Setting the Shape Builder tool options](#)” on page 255.

Pressing Shift+click+drag displays a rectangular marquee, which allows you to easily merge multiple paths.

- 7 To use the Erase mode of the Shape Builder tool, press the Alt key (Windows) or the Option key (Mac OS) and click the closed region that you want to delete. When you press the Alt key (Windows) or Option key (Mac OS), the pointer changes to .

In Erase mode, you can delete regions within selected shapes. If you delete a region that is shared by multiple objects, the shapes are broken in such a way that the regions selected by the marquee are removed from the shapes.

You can also delete edges in erase mode. This option is useful when you want to clear the remaining portions after creating the required shape.

Creating 3D objects

Note: 3D tools are independent of the Perspective Grid tools and 3D objects are treated like any other object in perspective.

Create 3D objects

3D effects enable you to create three-dimensional (3D) objects from two-dimensional (2D) artwork. You can control the appearance of 3D objects with lighting, shading, rotation, and other properties. You can also map artwork onto each surface of a 3D object.

There are two ways to create a 3D object: by extruding or revolving. In addition, you can also rotate a 2D or 3D object in three dimensions. To apply or modify 3D effects for an existing 3D object, select the object and then double-click the effect in the Appearance panel.

Note: 3D objects may display anti-aliasing artifacts on screen, but these artifacts won't print or appear in artwork optimized for the web.

For more information about working with 3D objects in Illustrator, see the 3D tutorials at www.adobe.com/go/learn_ai_tutorials_3d_en. For a video on creating 3D objects, see www.adobe.com/go/vid0053.

More Help topics

[3D tutorials](#)

[“Add a custom bevel path”](#) on page 264

Create a 3D object by extruding

Extruding extends a 2D object along the object's z axis to add depth to the object. For example, if you extrude a 2D ellipse, it becomes a cylinder.

Note: The object's axis always lies perpendicular to the object's front surface and moves relative to the object if the object is rotated in the 3D Options dialog box.

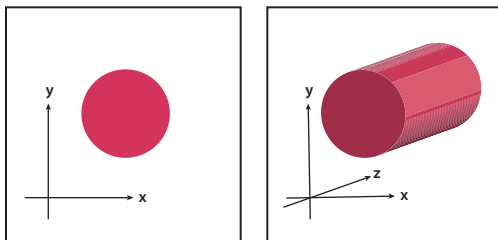

Extruding an object

- 1 Select the object.
- 2 Choose Effect > 3D > Extrude & Bevel.
- 3 Click More Options to view the complete list of options, or Fewer Options to hide the extra options.
- 4 Select Preview to preview the effect in the document window.
- 5 Specify options:

Position Sets how the object is rotated and the perspective from which you view it. (See [“Set 3D rotation position options”](#) on page 261.)

Extrude & Bevel Determines the object's depth and the extent of any bevel added to or cut from it. (See [“Extrude & Bevel options”](#) on page 261.)

Surface Creates a wide variety of surfaces, from dull and unshaded matte surfaces to glossy and highlighted surfaces that look like plastic. (See [“Surface shading options”](#) on page 262.)

Lighting Adds one or more lights, varies the light intensity, changes the object's shading color, and moves lights around the object, for dramatic effects. (See “[Lighting options](#)” on page 263.)

Map Maps artwork onto the surfaces of a 3D object. (See “[Map artwork to a 3D object](#)” on page 265.)

6 Click OK.

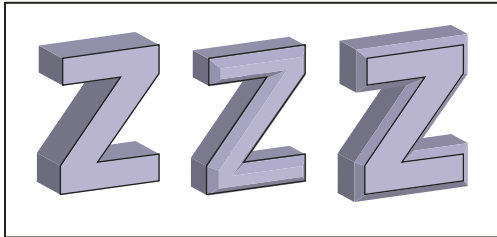

Extruded object without a beveled edge (left) compared to object with Bevel Extent In (middle) and with Bevel Extent Out (right)

Create a 3D object by revolving

Revolving sweeps a path or *profile* in a circular direction around the global *y* axis (revolve axis) to create a 3D object. Because the revolve axis is vertically fixed, the open or closed path that you revolve typically needs to depict half of the desired 3D object's profile in a vertical and front-facing position; you can then rotate the 3D object's position in the effect's dialog box.

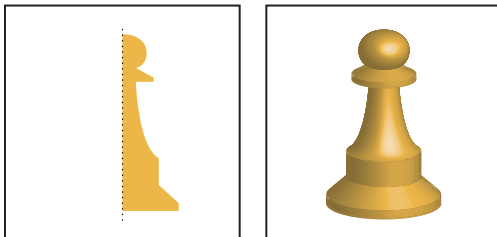

Revolving an object

1 Select the object.

Note: Applying the 3D Revolve effect to one or more objects simultaneously revolves each object around its own axis. Each object resides in its own 3D space and can't intersect other 3D objects. Applying the Revolve effect to a targeted group or layer, on the other hand, revolves the objects around a single axis.

 *Revolving a filled path with no stroke is much faster than revolving a stroked path.*

2 Choose Effect > 3D > Revolve.

3 Select Preview to preview the effect in the document window.

4 Click More Options to view the complete list of options, or Fewer Options to hide the extra options.

Position Sets how the object is rotated and the perspective from which you view it. (See “[Set 3D rotation position options](#)” on page 261.)

Revolve Determines how to sweep the path around the object to turn it into three dimensions. (See “[Revolve options](#)” on page 262.)

Surface Creates a wide variety of surfaces, from dull and unshaded matte surfaces to glossy and highlighted surfaces that look like plastic. (See “[Surface shading options](#)” on page 262.)





Lighting Adds one or more lights, varies the light intensity, changes the object's shading color, and moves lights around the object, for dramatic effects. (See "Lighting options" on page 263.)

Map Maps artwork onto the surfaces of a 3D object. (See "Map artwork to a 3D object" on page 265.)

5 Click OK.

Set 3D rotation position options

❖ Do any of the following:

- Choose a preset position from the Position menu.
- For unconstrained rotation, drag a track cube face. The front of the object is represented by the track cube's blue face, the object's top and bottom faces are light gray, the sides are medium gray, and the back face is dark gray.
- To constrain the rotation along a global axis, hold down Shift while dragging horizontally (global *y* axis) or vertically (global *x* axis). To rotate the object around the global *z* axis, drag in the blue band that surrounds the track cube.
- To constrain the rotation around an object axis, drag an edge on the track cube. The pointer changes to a double-sided arrow , and the cube edge changes color to identify the axis around which the object will rotate. Red edges represent the object's *x* axis, green edges represent the object's *y* axis, and blue edges represent the object's *z* axis.
- Enter values between -180 and 180 in the horizontal (*x*) axis , vertical (*y*) axis , and depth (*z*) axis  text boxes.
- To adjust the perspective, enter a value between 0 and 160 in the Perspective text box. A smaller angle is similar to a telephoto camera lens; a larger lens angle is similar to a wide-angle camera lens.

Note: A lens angle that is higher than 150 may result in objects extending beyond your point of view and appearing distorted. Also, keep in mind that there are object *x*, *y*, and *z* axes and global *x*, *y*, and *z* axes. Object axes remain relative to an object's position in its 3D space. Global axes remain fixed relative to the computer screen; the *x* axis lies horizontally, the *y* axis lies vertically, and the *z* axis lies perpendicular to the computer screen.

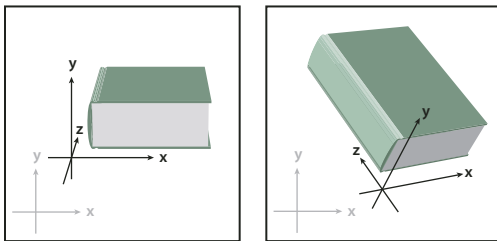

Object axes (in black) move with the object; global axes (in gray) are fixed.

Extrude & Bevel options

Extrude Depth Sets the depth of the object, using a value between 0 and 2000.

Cap Specifies whether the object appears solid (Revolve Cap On ) or hollow (Revolve Cap Off ) .

Bevel Applies the type of beveled edge you choose along the depth (*z* axis) of the object.

Height Sets the height between 1 and 100. Bevel heights that are too large for an object may cause the object to self-intersect and produce unexpected results.

Bevel Extent Out  Adds the bevel to the object's original shape.

Bevel Extent In  Carves the bevel out of the object's original shape.

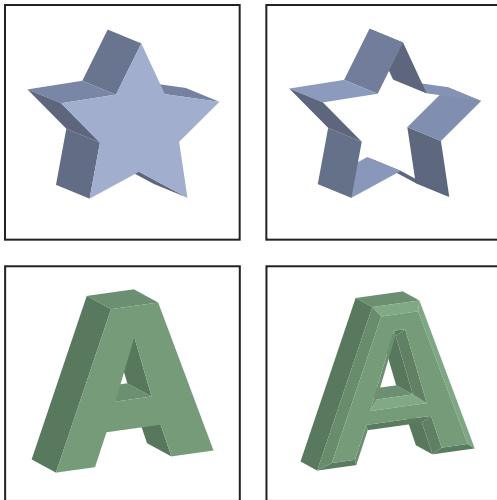

Extruded object with cap (top left) compared to no cap (top right); object without a beveled edge (bottom left) compared to object with a beveled edge (bottom right)

Revolve options

Angle Sets the number of degrees to revolve the path, between 0 and 360.

Cap Specifies whether the object appears solid (Revolve Cap On) or hollow (Revolve Cap Off) .

Offset Adds distance between the revolve axis and the path, to create a ring-shaped object, for instance. You can enter a value between 0 and 1000.

From Sets the axis around which the object revolves, either the Left Edge or Right Edge.

Surface shading options

Surface Lets you choose options for the shading surfaces:

- **Wireframe** Outlines the contours of the object's geometry and makes each surface transparent.
- **No Shading** Adds no new surface properties to the object. The 3D object has the same color as the original 2D object.
- **Diffuse Shading** Makes the object reflect light in a soft, diffuse pattern.
- **Plastic Shading** Makes the object reflect light as if it were made of a shiny, high-gloss material.

Note: Depending on what option you choose, different lighting options are available. If the object only uses the 3D Rotate effect, the only Surface choices available are Diffuse Shading or No Shading.

Light Intensity Controls the light intensity between 0% and 100%.

Ambient Light Controls the global lighting, which changes the brightness of all the object's surfaces uniformly. Enter a value between 0% and 100%.

Highlight Intensity Controls how much the object reflects light, with values ranging from 0% to 100%. Lower values produce a matte surface, and higher values create a shinier-looking surface.

Highlight Size Controls the size of the highlight from large (100%) to small (0%).

Blend Steps Controls how smoothly the shading appears across the object's surfaces. Enter a value between 1 and 256. Higher numbers produce smoother shades and more paths than lower numbers.

Draw Hidden Faces Displays the object's hidden backfaces. The backfaces are visible if the object is transparent, or if the object is expanded and then pulled apart.

Note: If your object has transparency and you want the hidden backfaces to display through the transparent front faces, apply the Object > Group command to the object before you apply the 3D effect.

Preserve Spot Color (Extrude & Bevel effect, Revolve effect, and Rotate effect) Lets you preserve spot colors in the object. Spot colors can't be preserved if you chose Custom for the Shading Color option.

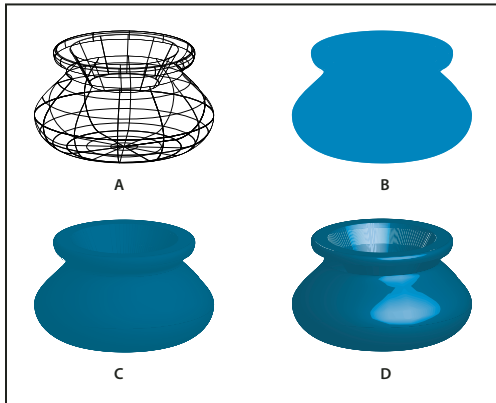



Examples of different surface shading choices
A. Wireframe B. No shading C. Diffuse shading D. Plastic shading

Lighting options

Light Defines where the light is. Drag the light to where you want it on the sphere.

Move Light Back button  Moves the selected light behind the object.

Move Light Front button  Moves the selected light in front of the object.

New Light button  Adds a light. By default, new lights appear in the front center of the sphere.

Delete Light button Deletes the selected light.

Note: By default, 3D Effects assigns one light to an object. You can add and delete lights, but the object must always have at least one light.

Light Intensity Changes the selected light's intensity between 0% and 100%.

Shading Color Controls the object's shading color, depending on the command you choose:

- **None** Adds no color to the shading.
- **Custom** Lets you choose a custom color. If you choose this option, click the Shade Color box to select a color in the Color Picker. Spot colors are changed to process colors.
- **Black Overprint** Avoids process colors if you're using a spot color workflow. The object is shaded by overprinting shades of black on top of the object's fill color. To view the shading, choose View > Overprint Preview.
- **Preserve Spot Color** Lets you preserve spot colors in the object. Spot colors can't be preserved if you chose Custom for the Shading Color option.

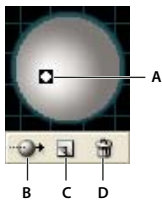

Lighting Sphere

A. Selected light in front B. Move selected light to back or front button C. New light button D. Delete light button

Add a custom bevel path

- 1 Open the Bevels.ai file, which is located in the Adobe Illustrator CS5\Support Files\Required\Resources\en_US\ folder (Windows) or Adobe Illustrator CS5\Required\Resources\en_US folder ((Mac OS).
- 2 Create a single open path in the Bevels.ai file.
- 3 Choose Window > Symbols, and do one of the following to make the path a symbol:
 - Drag the path to the Symbols panel.
 - With the path selected, click the New Symbol button  in the Symbols panel or choose New Symbol from the panel menu.
- 4 To rename the symbol, double-click the symbol in the Symbols panel, enter a name in the Symbol Options dialog box, and click OK.
- 5 Choose File > Save.
- 6 Quit Illustrator and then relaunch Illustrator.

The Bevel menu in the 3D Extrude & Bevel Options dialog box lists the bevel.

- 7 To apply the custom bevel, do one of the following:
 - To apply the bevel to an extruded 3D object, select the 3D object, and then double-click the 3D Extrude & Bevel effect in the Appearance panel. In the 3D Extrude & Bevel Options dialog box, choose the bevel from the Bevel menu.
 - To apply the custom bevel to 2D artwork, select the 2D object, and then choose Effect > 3D > Extrude & Bevel. In the 3D Extrude & Bevel Options dialog box, choose the custom bevel from the Bevel menu.

Rotate an object in three dimensions

- 1 Select the object.
- 2 Choose Effect > 3D > Rotate.
- 3 Select Preview to preview the effect in the document window.
- 4 Click More Options to view the complete list of options, or Fewer Options to hide the extra options.
- 5 Specify options:

Position Sets how the object is rotated and the perspective from which you view it. (See “[Set 3D rotation position options](#)” on page 261.)

Surface Creates a wide variety of surfaces, from dull and unshaded matte surfaces to glossy and highlighted surfaces that look like plastic. (See “[Surface shading options](#)” on page 262.)

- 6 Click OK.

Map artwork to a 3D object

Every 3D object is composed of multiple surfaces. For example, an extruded square becomes a cube that is made of six surfaces: the front and back faces, and the four side faces. You can map 2D artwork to each surface on a 3D object. For example, you might want to map a label or text onto a bottle-shaped object or simply add different textures to each side of an object.

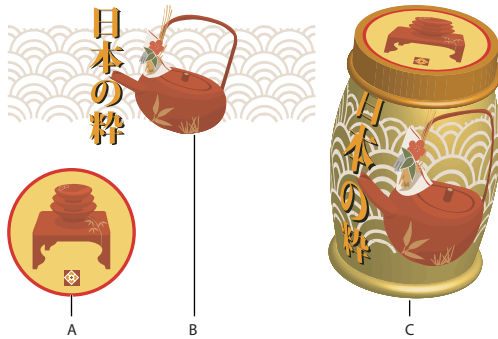





3D object with artwork mapped to each side
A. Symbol artwork B. Symbol artwork C. A and B mapped to 3D object

You can only map 2D artwork that's stored in the Symbols panel to a 3D object. Symbols can be any Illustrator art object, including paths, compound paths, text, raster images, mesh objects, and groups of objects.

When mapping 3D objects, consider the following:

- Because the Map Art feature uses symbols for mapping, you can edit a symbol instance and then automatically update all surfaces that are mapped with it.
- You can interact with the symbol in the Map Art dialog box with normal bounding box controls to move, scale, or rotate the object.
- The 3D effect remembers each mapped surface on an object as a number. If you edit the 3D object or apply the same effect to a new object, there may be fewer or more sides than the original. If there are fewer surfaces than the number of surfaces defined for the original mapping, the extra artwork will be ignored.
- Because a symbol's position is relative to the center of an object surface, if the geometry of the surface changes, then the symbol will be remapped relative to the new center of the object.
- You can map artwork to objects that use the Extrude & Bevel or Revolve effect, but you can't map artwork to objects that only use the Rotate effect.

- 1 Select the 3D object.
- 2 In the Appearance panel, double-click the 3D Extrude & Bevel or 3D Revolve effect.
- 3 Click Map Art.
- 4 Choose the artwork to map to the selected surface from the Symbol pop-up menu.
- 5 To select which object surface you want to map, click the first , previous , next , and last  surface arrow buttons, or enter a surface number in the text box.

A light gray color mark appears on the surfaces that are currently visible. A dark gray color mark appears on the surfaces that are hidden by the object's current position. When a surface is selected in the dialog box, the selected surface is outlined in red in the document window.

6 Do any of the following:

- To move the symbol, position the pointer inside the bounding box and drag; to scale, drag a side or corner handle; to rotate, drag outside and near a bounding box handle.
- To make the mapped artwork fit to the boundaries of the selected surface, click Scale To Fit.
- To remove artwork from a single surface, select the surface using the Surface options, and then either choose None from the Symbol menu or click Clear.
- To remove all maps from all of the 3D object's surfaces, click Clear All.
- To shade and apply the object's lighting to the mapped artwork, select Shade Artwork.
- To show only the artwork map, not the geometry of a 3D object, select Invisible Geometry. This is useful when you want to use the 3D mapping feature as a three-dimensional warping tool. For example, you could use this option to map text to the side of an extruded wavy line, so that the text appears warped as if on a flag.
- To preview the effect, select Preview.

7 Click OK in the Map Artwork dialog box.

Note: 3D tools are independent of Illustrator's Perspective Grid tools. 3D objects are treated like any other art when placed in Perspective Grid.

Chapter 8: Importing, exporting, and saving

Importing files

You don't have to create artwork from scratch in Adobe Illustrator—you can import both vector drawings and bitmap images from files created in other applications. Illustrator recognizes all common graphic file formats. Tight integration between Adobe products and support for a wide variety of file formats, makes it easy to move art from one application to another by importing, exporting, or copying and pasting.

About linked and embedded artwork

When you place a graphic, you will see a screen-resolution version of the file in the layout, so that you can view and position it, but the actual graphic file may be either *linked* or *embedded*.

- Linked artwork is connected to, but remains independent of, the document, resulting in a smaller document. You can modify linked artwork using transformation tools and effects; however, you cannot select and edit individual components in the artwork. You can use the linked graphic many times without significantly increasing the size of the document; you can also update all links at once. When you export or print, the original graphic is retrieved, creating the final output from the full resolution of the originals.
- Embedded artwork is copied into the document at full resolution, resulting in a larger document. You can update the document whenever you like; as long as the artwork is embedded, your document is self-sufficient.

To determine if artwork is linked or embedded, or change its status from one to the other, use the Links panel.

If the embedded artwork contains multiple components, you can edit them discretely. For example, if the artwork contains vector data, Illustrator converts it to paths, which you can then modify using Illustrator tools and commands. Illustrator also preserves the object hierarchy (such as groups and layers) in artwork embedded from certain file formats.

For a video on importing and copying and pasting between web applications, see www.adobe.com/go/vid0193.

Note: For information on importing Adobe® FreeHand® files into Illustrator, see the *Migrating from FreeHand to Illustrator PDF* at www.adobe.com/go/learn_ai_freehand_en.

More Help topics

[FreeHand migration](#)

Place (import) files

The Place command is the primary method of importing, because it provides the highest level of support for file formats, placement options, and color. After you place a file, use the Links panel to identify, select, monitor, and update it.

- 1 Open the Illustrator document into which you want to place the artwork.
- 2 Choose File > Place, and select the file you want to place.
- 3 Select Link to create a link to the file, or deselect Link to embed the artwork in the Illustrator document.
- 4 Click Place.

5 If applicable, do one of the following:

- If you place a PDF file with multiple pages, you can choose which page you want to place and how to crop the artwork.
- If you embed an Adobe® Photoshop® file, you can choose how to convert layers. If the file contains layer comps, you can also choose which version of the image to import.

For a video on importing files into Illustrator, see www.adobe.com/go/vid0033. For a video on importing and copying and pasting between web applications, see www.adobe.com/go/vid0193.

More Help topics

[“About linked and embedded artwork”](#) on page 267

[“Adobe PDF placement options”](#) on page 273

[“Photoshop import options”](#) on page 276

Links panel overview

You use the Links panel to see and manage all linked or embedded artwork. The panel displays a small thumbnail of the artwork and uses icons to indicate artwork’s status.

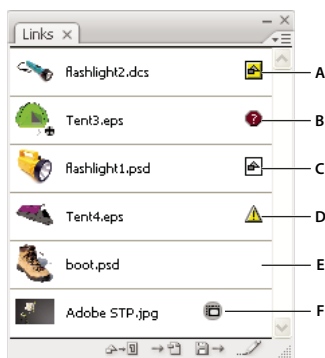

Links panel

A. Transparency interaction B. Missing artwork C. Embedded artwork D. Modified artwork E. Linked artwork F. Adobe stock photo comp image

More Help topics

[“Workspace overview”](#) on page 5

File status options for the Links panel

A linked file can appear in the Links panel in any of the following ways:

Up-to-date An up-to-date file displays only the file’s name and (in Adobe® InDesign®) its page in the document.

Modified A modified file is one for which the version of the file on disk is more recent than the version in your document. This would occur, for example, when someone modifies a Photoshop graphic that you have already placed into Illustrator.

Missing A missing file is one for which the graphic is no longer in the location from which it was imported, although it may still exist somewhere. This can happen if someone moves the original file to a different folder or server after it’s been imported into a document. You can’t know whether a missing file is up to date until its original is located. If you print or export a document when this icon is displayed, the file may not print or export at full resolution.

Embedded Embedding the contents of a linked file suspends management operations for that link.

Work with the Links panel

- To display the panel, choose Window > Links. Each linked file and embedded file is identified by name.
- To select and view a linked graphic, select a link and then click the Go To Link button , or choose Go To Link in the Links panel menu. The display is centered around the selected graphic.
- To change the size of the thumbnails, select panel Options from the Links panel menu, and select an option for displaying thumbnails.
- To sort links in a different order, choose the desired Sort command in the panel menu.
- To hide thumbnails, select panel Options from the Links panel menu, and choose None.
- To view DCS Transparency information, select panel Options from the Links panel menu, and choose Show DCS Transparency Interactions.

View and save metadata via the Links panel

If a linked or embedded file contains metadata, you can view the metadata using the Links panel. You cannot edit or replace metadata associated with a linked file; however, you can save a copy of the metadata in a template and apply it to other files.

- 1 Select a file in the Links panel and choose Link File Info from the panel menu.
- 2 To save the metadata as a template, choose Save Metadata Template in the pop-up menu at the top of the dialog box showing the metadata.

More Help topics

[“About metadata”](#) on page 302

View file information about linked or embedded artwork

❖ Do any of the following:



- Double-click the link in the Links panel. Alternatively, select the link and select Link Information from the panel menu.

Note: Don't confuse “Link information” with “Link File Info” in the Links panel menu; “File Info” refers to metadata.

- Select the linked artwork in the illustration window. In the Control panel, click the file name and choose Link Information.

 *To locate linked or embedded artwork in the document window, select a link and click the Go To Link button. Alternatively, select Go To Link from the panel menu.*

Update modified links

- To update specific links, in the Links panel select one or more modified links , and then click the Update Link button  or choose Update Link from the Links panel menu.
- To update specific links, select the linked artwork in the illustration window. In the Control panel, click the filename, and then choose Update Link.

Note: By default, Illustrator prompts you to update a link if the source file changes. To specify that you want to update links automatically or manually, choose *Edit > Preferences > File Handling & Clipboard (Windows)* or *Illustrator > Preferences > File Handling & Clipboard (Mac OS)*, and set the *Update Links* option.

Restore a single missing link or replace link with a different source file

You can restore or replace a missing link—one that shows the missing-link icon  in the Links panel—or any linked file with a different source file.

- 1 Select the linked artwork on the page, or select a link name in the Links panel.
- 2 Do one of the following:
 - In the Links panel, click the Relink button , or choose Relink from the panel menu.
 - Click the linked filename in the Control panel, and then choose Relink. (To access this option, you must select the image in the artwork.)
- 3 In the dialog box that appears, do one of the following:
 - Locate and select a replacement file.
 - Type the first, or first few, letters of the name of the desired replacement file to locate the file.
- 4 Click Place.

Note: If all of a document's missing links are located in the same folder, you can restore all of them at once. In the Links panel, select all of the missing links, and then restore one of them; the Place dialog box stays open for you to reselect each one.

Set placement options for linked artwork

- 1 Do one of the following:
 - Select the linked artwork in the illustration window. In the Control panel, click the filename and choose Placement Options.
 - In the Links panel, select the link and choose Placement Options from the panel menu.
- 2 Select an option for Preserve.

If you select an option other than Transforms or Bounds, you can select a point on the Alignment icon from which you want to align the artwork, relative to the bounding box. If you want to keep the artwork from overlapping the bounding box, select Clip To Bounding Box.

More Help topics

[“Links panel overview”](#) on page 268

[“About linked and embedded artwork”](#) on page 267

[“Control panel overview”](#) on page 8

Embed a linked file

Rather than linking to a file that you've placed in a document, you can embed (or store) the file within the document. When you embed a file, you break the link to the original. Without the link, the Links panel doesn't alert you when the original has changed, and you cannot update the file automatically.

Keep in mind that embedding a file, rather than linking to the original, increases the document file size.

- 1 Select a file in the Links panel, and choose Embed Image from the panel menu.

2 Select the linked artwork in the illustration window. In the Control panel, click the Embed button.

The file remains in the Links panel marked with the embedded-link icon .

Unembed or relink an embedded file

- 1 Select one or more embedded files in the Links panel.
- 2 Click the Relink button  or select Relink in the Links panel menu, locate and select the original file, and click Place.

Edit original artwork

The Edit Original command lets you open most graphics in the application in which you created them so that you can modify them as necessary. Once you save the original file, the document in which you linked it is updated with the new version.

- 1 Do any of the following:
 - In the Links panel, select the link and click the Edit Original button . Alternatively, choose Edit Original from the panel menu.
 - Select the linked artwork on the page, and choose Edit > Edit Original.
 - Select the linked artwork on the page, and click the Edit Original button in the Control panel.
- 2 After making changes in the original application, save the file.

Importing bitmap images

About bitmap images

Bitmap images—technically called *raster images*—use a rectangular grid of picture elements (pixels) to represent images. Each pixel is assigned a specific location and color value. When working with bitmap images, you edit pixels rather than objects or shapes. Bitmap images are the most common electronic medium for continuous-tone images, such as photographs or digital paintings, because they can more efficiently represent subtle gradations of shades and color.

Bitmap images are resolution-dependent—that is, they contain a fixed number of pixels. As a result, they can lose detail and appear jagged if they are scaled to high magnifications on-screen or if they are printed at a lower resolution than they were created for.



Example of a bitmap image at different levels of magnification

Bitmap images sometimes require large amounts of storage space, and often need to be compressed to keep file sizes down when used in certain Creative Suite components. For instance, you compress an image file in its original application before you import it into a layout.

Note: In Adobe Illustrator, you can create bitmap effects in your artwork using effects and graphic styles.

More Help topics

[“About vector graphics”](#) on page 50

Image resolution guidelines for final output

Bitmap images contain a fixed number of pixels, usually measured in pixels per inch (ppi). An image with a high resolution contains more, and therefore smaller, pixels than an image of the same printed dimensions with a low resolution. For example, a 1-inch-by-1-inch image with a resolution of 72 ppi contains a total of 5184 pixels (72 pixels wide x 72 pixels high = 5184). The same 1-inch-by-1-inch image with a resolution of 300 ppi would contain a total of 90,000 pixels.

For imported bitmap images, image resolution is determined by the source file. For bitmap effects, you can specify a custom resolution. To determine the image resolution to use, consider the medium of final distribution for the image. The following guidelines can help you determine your requirements for image resolution:

Commercial printing Commercial printing requires 150 to 300 ppi (or more) images, depending on the press (dpi) and screen frequency (lpi) you’re using; always consult your prepress service provider before making production decisions. Because commercial printing requires large, high-resolution images, which take more time to display while you’re working with them, you may want to use low-resolution versions for layout and then replace them with high-resolution versions at print time.

In Illustrator and InDesign, you can work with low resolution versions by using the Links panel. In InDesign you can choose either Typical or Fast Display from the View > Display Performance menu; in Illustrator you can choose View > Outline. Alternatively, if your service provider supports Open Prepress Interface (OPI), they may provide low-resolution images to you.

Desktop printing Desktop printing usually requires images within the range of 72 ppi (for photographs printed on a 300 ppi printer) to 150 ppi (for photographs printed on devices up to 1000 ppi). For line art (1-bit images), make sure that the resolution of your graphics matches the resolution of the printer.

Web publishing Because online publishing generally requires images with pixel dimensions that fit the intended monitor, the images are usually less than 500 pixels wide and 400 pixels tall, to leave room for browser window controls or such layout elements as captions. Creating an original image at screen resolution—96 ppi for Windows-based images, and 72 ppi for Mac OS-based images—lets you see the image as it will likely appear when viewed from a typical web browser. When you’re publishing online, the only times you’re likely to need resolutions above those ranges are when you want viewers to be able to zoom in for more detail in a PDF document, or when you’re producing a document for printing on demand.

Importing Adobe PDF files

Importing Adobe PDF files

Adobe Portable Document Format (PDF) is a versatile file format that can represent both vector and bitmap data. You can bring artwork from PDF files into Illustrator using the Open command, the Place command, the Paste command, and the drag-and-drop feature.

- Use the Place command with the Link option selected to import a PDF file (or one page of the PDF if it is a multi-page document) as a single image. You can modify the linked image using transformation tools; however, you cannot select and edit its individual components.
- Use the Open command or the Place command with the Link option deselected to edit the contents of a PDF file. Illustrator recognizes the individual components in the PDF artwork and lets you edit each component as a discrete object.
- Use the Paste command or the drag-and-drop feature to import selected components from a PDF file, including vector objects, bitmap images, and text.

Note: If you are color-managing artwork in a document, embedded PDF images are part of the document and therefore color-managed when sent to a printing device. In contrast, linked PDF images are not color-managed, even if color management is turned on for the rest of the document.

More Help topics

[“About linked and embedded artwork”](#) on page 267

Adobe PDF placement options

When you place an Adobe PDF file, you specify which page you want to import. You also choose how to crop the artwork by selecting a Crop To option:

Bounding Box Places the PDF page’s bounding box, or the minimum area that encloses the objects on the page, including page marks.

Art Places the PDF only in the area defined by a rectangle that the author created as placeable artwork (for example, clip art).

Crop Places the PDF only in the area that is displayed or printed by Adobe Acrobat.

Trim Identifies the place where the final produced page will be physically cut in the production process, if trim marks are present.

Bleed Places only the area that represents where all page content should be clipped, if a bleed area is present. This information is useful if the page is being output in a production environment. Note that the printed page may include page marks that fall outside the bleed area.

Media Places the area that represents the physical paper size of the original PDF document (for example, the dimensions of an A4 sheet of paper), including page marks.

More Help topics

[“Place \(import\) files”](#) on page 267

Importing monotone, duotone, and tritone images from Adobe PDF files

When you import artwork from an Adobe PDF file, it's possible to introduce data that you can't create within Illustrator. This is called *non-native art* and includes monotone, duotone, and tritone images. You can also generate non-native art within Illustrator by using the Flatten Transparency command to preserve spot colors.

 *Illustrator's ability to preserve non-native art is useful in many situations. For example, Illustrator maintains the spot color information in linked PDF files when you output color separations.*

By default, non-native art is labeled <Non-Native Art> in the Layers and Appearance panels. You can select, move, save, and perform basic transformations (such as scaling, rotating, or skewing) on non-native art. However, you cannot select and edit its individual components. In addition, you must rasterize non-native art before editing it with the liquify tools.

To convert non-native art to an Illustrator object, choose Object > Rasterize.

More Help topics

[“Importing Adobe PDF files”](#) on page 273

[“Rasterize a vector object”](#) on page 283

Importing EPS, DCS, and AutoCAD files

Importing EPS files

Encapsulated PostScript (EPS) is a popular file format for transferring vector artwork between applications. You can bring artwork from EPS files into Illustrator using the Open command, the Place command, the Paste command, and the drag-and-drop feature.

Keep the following in mind when working with EPS artwork:

- When you open or embed an EPS file that was created in another application, Illustrator converts all objects to native Illustrator objects. However, if the file contains data that Illustrator doesn't recognize, some loss of data may occur. As a result, unless you need to edit the individual objects in an EPS file, it's best to link to the file rather than open or embed it.
- EPS format does not support transparency; therefore, it is not a good choice for placing transparent artwork from other applications into Illustrator. Instead, use PDF 1.4 format for this purpose.
- You may receive an error message when printing or saving artwork that includes linked EPS files, if those files were saved in binary format (for example, in Photoshop's default EPS format). In this case, resave the EPS files in ASCII format, embed the linked files into the Illustrator artwork, print to a Binary print port instead of an ASCII print port, or save the artwork in AI or PDF format instead of EPS format.
- If you are color-managing artwork in a document, embedded EPS images are part of the document and therefore color-managed when sent to a printing device. In contrast, linked EPS images are not color-managed, even if color management is turned on for the rest of the document.

- If you import an EPS color that has the same name as a color in your document but a different definition, Illustrator displays an alert. Select Use Linked File's Color to replace the color in your document with the EPS color in the linked file. All objects using this color in your document will get updated appropriately. Select Use Document's Color to leave the swatch as is and resolve all color conflicts using the document's color. The EPS preview cannot be changed, so the preview may be incorrect, but it will print to the correct plates. Selecting Apply to All will resolve all color conflicts, using the definition either of the document or the linked file, depending on which option you choose.
- Occasionally you may encounter a warning when opening an Illustrator document containing embedded EPS images. If the application cannot find the original EPS image, you will be prompted to extract the EPS image. Select the Extract option in the dialog box; the image will be extracted into the same directory as the current document. Although the embedded file does not preview in the document, the file will now print correctly.
- By default, linked EPS files are displayed as a high resolution preview. If a linked EPS file isn't visible in the document window, it may be because the file's preview is missing. (Previews are sometimes lost when transferring EPS files saved with PICT previews from Mac OS to Windows.) To restore the preview, resave the EPS file with a TIFF preview. If performance is negatively affected when you place the EPS, reduce the preview resolution: choose Edit > Preferences > File Handling & Clipboard (Windows) or Illustrator > Preferences > File Handling & Clipboard (Mac OS), and select Use Low Resolution Proxy For Linked EPS.

More Help topics

[“About linked and embedded artwork”](#) on page 267

[“Save in EPS format”](#) on page 279

Importing DCS files

Desktop Color Separation (DCS) is a version of the standard EPS format. The DCS 1.0 format supports only CMYK images while the DCS 2.0 format supports multichannel CMYK files as well as multiple spot inks. (These spot inks appear as spot colors in Illustrator's Swatches panel.) Illustrator recognizes clipping paths in Photoshop-created DCS 1.0 and DCS 2.0 files. You can link DCS files in Illustrator, but you can't embed or open them.



To see DCS transparency interactions in the Links panel, choose Panel Options from the Links panel menu and select Show DCS Transparency Interactions.

Importing AutoCAD files

AutoCAD files include both DXF and DWG formats. You can import AutoCAD files from version 2.5 through version 2006. During import, you can specify scale, unit mapping (custom unit for interpreting all the length data in the AutoCAD file), whether to scale lineweights, which layout to import, and whether to center the artwork.

Illustrator supports most AutoCAD data, including 3D objects, shapes and paths, external references, region objects, spline objects (mapped to Bezier objects that retain the original shape), raster objects, and text objects. When importing an AutoCAD file that contains external references, Illustrator reads the contents of the reference and places it at the appropriate locations in the Illustrator file. If an external reference is not found, the Missing Link dialog box opens so you can search for and retrieve the file.

Importing artwork from Photoshop

Importing artwork from Photoshop

You can bring artwork from Photoshop (PSD) files into Illustrator using the Open command, the Place command, the Paste command, and the drag-and-drop feature.

Illustrator supports most Photoshop data, including layer comps, layers, editable text, and paths. This means that you can transfer files between Photoshop and Illustrator without losing the ability to edit the artwork. For easy transfer of files between the two applications, adjustment layers that have visibility turned off are imported (though inaccessible) into Illustrator and restored when exported back to Photoshop.

Spot colors (up to 31 spot channels per file) import as a single N-Channel raster image, which is placed over the process color image. The spot colors are added to the swatches panel as custom colors with the same name as in Photoshop. Imported spot colors separate correctly.

Duotone PSD files import as flat raster images with a 256-indexed colorspace and an N-Channel colorspace containing all of the duotone inks. Because Illustrator uses an N-Channel, blending mode interactions set in Photoshop may appear differently in Illustrator. Ink colors from old color libraries are set to gray.

In cases where Illustrator must convert the Photoshop data, a warning message appears. For example, when importing a 16-bit Photoshop file, Illustrator warns you that the image will be imported as an 8-bit, flat composite.

Photoshop import options

When you open or place a Photoshop file that contains multiple layers, you can set the following options:

Layer Comp If the Photoshop file contains layer comps, specifies which version of the image to import. Select Show Preview to display a preview of the selected layer comp. The Comments text box displays comments from the Photoshop file.

When Updating Link Specifies how to handle layer visibility settings when updating a linked Photoshop file that includes layer comps.

- **Keep Layer Visibility Overrides** Updates the linked image based on the state of layer visibility in the layer comp when you originally placed the file.
- **Use Photoshop's Layer Visibility** Updates the linked image based on the current state of layer visibility in the Photoshop file.

Convert Photoshop Layers To Objects And Make Text Editable Where Possible Preserves as much layer structure and text editability as possible without sacrificing appearance. However, if the file includes features that Illustrator doesn't support, Illustrator preserves the appearance of the artwork by merging and rasterizing layers. For example:

- Layer sets that use the Dissolve blending mode as well as all layers in clipping masks get merged into single layers.
- Adjustment layers and layers that use a Knockout option are merged with the underlying layers, as are layers that contain transparent pixels and use the Color Dodge, Color Burn, Difference, Linear Burn, Linear Dodge, Vivid Light, Linear Light, or Pin Light blending mode.
- Layers that use layer effects may be merged; however, the specific merging behavior depends on the blending mode of the layer, the presence of transparent pixels, and the layer's blending options.
- Hidden layers that require merging are discarded.

Note: The Convert Photoshop Layers To Objects And Make Text Editable Where Possible option is not available when you link to a Photoshop file.

Flatten Photoshop Layers To A Single Image And Preserve Text Appearance Imports the file as a single bitmap image. The converted file retains no individual objects, except for the document clipping path (if one exists). Opacity is retained as part of the main image, but is not editable.

Import Hidden Layers Imports all layers from the Photoshop file, even those that are hidden. This option is not available when linking to a Photoshop file.

Import Slices Preserves any slices that are included in the Photoshop file. This option is available only when opening or embedding a file that includes slices.

Move part of an image from Photoshop to Illustrator

- 1 In Photoshop, select the pixels you want to move. For more information, see Photoshop Help.
- 2 Do one of the following:
 - Copy the selection in Photoshop and paste it in Illustrator. If a layer mask is active when you choose the Copy command, Photoshop copies the mask rather than the main layer.
 - Select the Move tool in Photoshop, and drag the selection to Illustrator. Illustrator fills transparent pixels with white.

Move paths from Photoshop to Illustrator

- 1 In Photoshop, use the Path Component Selection tool or the Direct Selection tool to select the paths you want to move.

You can select any path or path segment that appears in the Paths panel, including shape vector masks, work paths, and saved paths. For more information on selecting paths, see Photoshop Help.

- 2 Either copy and paste or drag the path to Illustrator.
- 3 In the Paste Options dialog box, choose whether to paste the path as a compound shape or a compound path. Pasting as a compound path is faster, but may result in some loss of editability.



To import all paths (but no pixels) from a Photoshop document, choose File > Export > Paths To Illustrator (in Photoshop). Then open the resulting file in Illustrator.

Saving artwork

About saving artwork

When you save or export artwork, Illustrator writes the artwork data to a file. The structure of the data depends on the file format that you select.

There are five basic file formats—AI, PDF, EPS, FXG, and SVG—to which you can save artwork. These formats are called *native formats* because they can preserve all Illustrator data, including multiple artboards. (For PDF and SVG formats, you must select the Preserve Illustrator Editing Capabilities options to preserve all Illustrator data.) EPS and FXG can save individual artboards as separate files. SVG saves the active artboard only; however, the content from all artboards is displayed.

You can also export artwork in a variety of file formats for use outside of Illustrator. These formats are called *non-native formats* because Illustrator will not be able to retrieve all of the data if you reopen the file in Illustrator. For this reason, it is recommended that you save artwork in AI format until you are finished creating it, and then export the artwork to the desired format.

Note: You may receive an error message when saving artwork that includes linked EPS files, if those files were saved in binary format (for example, in Photoshop's default EPS format). In this case, resave the EPS files in ASCII format, embed the linked files into the Illustrator artwork, or save the artwork in AI or PDF format instead of EPS format.

For a video on creating mobile content in Illustrator, see www.adobe.com/go/vid0207. For a video on saving for the web, see www.adobe.com/go/vid0063. For a video on exporting content from Illustrator, including an overview on different formats and when you should use them, see www.adobe.com/go/vid0062.

More Help topics

“About Adobe PDF” on page 290

Save in Illustrator format

If your document contains more than one artboard and you want to save to a previous version of Illustrator, you can choose to save each artboard as a separate file or combine the content from all artboards into a single file.

- 1 Choose File > Save As or File > Save A Copy.
- 2 Type a filename, and choose a location for the file.
- 3 Choose Illustrator (*.AI) as the file format, and click Save.
- 4 In the Illustrator Options dialog box, set the desired options and click OK:

Version Specifies the version of Illustrator with which you want your file to be compatible. Legacy formats don't support all the features in the current version of Illustrator. Therefore, when you select a version other than the current version, some options for saving aren't available, and certain kinds of data will be changed. Be sure to read the warnings at the bottom of the dialog box so that you are aware of how the data will be changed.

Subset Embedded Fonts When Percent Of Characters Used Is Less Than Specifies when to embed the entire font (as opposed to just the characters used in the document) based on how many of the font's characters are used in the document. For instance, if a font contains 1,000 characters but the document only uses 10 of those characters, you may decide that embedding the font is not worth the extra file size.

Create PDF Compatible File Saves a PDF representation of the document in the Illustrator file. Select this option if you want the Illustrator file to be compatible with other Adobe applications.

Include Linked Files Embeds files that are linked to the artwork.

Embed ICC Profiles Creates a color-managed document.

Use Compression Compresses PDF data in the Illustrator file. Using compression increases the time required to save the document, so deselect this option if you're experiencing very slow (8 to 15 minute) save times.

Save Each Artboard To A Separate File Saves each artboard as a separate file. A separate master file that includes all of the artboards is also created. All of the content that touches an artboard is included with the file for that artboard. If artwork needs to be shifted to fit it onto a single artboard, a warning appears to let you know. If you don't select this option, the artboards are combined into a single document and are converted to object guides and (in Illustrator CS3) crop areas. The artboard used for the saved file is based on the size of the default document startup profile.

Transparency options Determines what happens to transparent objects when you choose a version of Illustrator format earlier than 9.0. Select Preserve Paths to discard transparency effects and reset transparent artwork to 100% opacity and Normal blending mode. Select Preserve Appearance And Overprints to preserve overprints that don't interact with transparent objects. Overprints that interact with transparent objects are flattened.

Important: If your artwork contains complex, overlapping areas and you require high-resolution output, click Cancel and specify rasterization settings before continuing.

More Help topics

[“Rasterization options”](#) on page 369

Save in EPS format

Virtually all page layout, word-processing, and graphic applications accept imported or placed encapsulated PostScript (EPS) files. The EPS format preserves many of the graphic elements you can create with Adobe Illustrator, which means that EPS files can be reopened and edited as Illustrator files. Because EPS files are based on the PostScript language, they can contain both vector and bitmap graphics. If your artwork contains multiple artboards, these artboards are preserved when you save to EPS format.

- 1 If your artwork contains transparency (including overprints) and you require high-resolution output, choose Window > Flattener Preview to preview the effects of flattening.
- 2 Choose File > Save As or File > Save A Copy.
- 3 Type a filename, and choose a location for the file.
- 4 Choose Illustrator EPS (*.EPS) as the file format, and click Save.
- 5 If you want create separate files for each artboard, click Use Artboards, and select All or specify a range. Separate files are saved with a master EPS file containing all artboards. If you deselect this option, a single EPS file is created with all artboards preserved.
- 6 In the EPS Options dialog box, set the desired options and click OK:

Version Specifies the version of Illustrator with which you want your file to be compatible. Legacy formats don't support all the features in the current version of Illustrator. Therefore, when you select a version other than the current version, some options for saving aren't available, and certain kinds of data will be changed. Be sure to read the warnings at the bottom of the dialog box so that you are aware of how the data will be changed.

Format Determines the characteristics of the preview image that is saved in the file. The preview image is displayed in applications that cannot display EPS artwork directly. If you don't want to create a preview image, choose None from the Format menu. Otherwise, select a black-and-white or color format.

If you select TIFF (8-bit Color) format, select a background option for the preview image:

- **Transparent** Produces a transparent background.
- **Opaque** Produces a solid background. (Select Opaque if the EPS document will be used in a Microsoft Office application.)

Transparency options Determines what happens to transparent objects and overprints. The available options change depending on the format version you select at the top of the dialog box.

If you choose a CS format, specify how to save overlapping colors that are set to overprint, and select a preset (or set of options) for flattening transparency. Click Custom to customize the flattener settings.

If you choose a Legacy format earlier than 8.0, select Preserve Paths to discard transparency effects and reset transparent artwork to 100% opacity and Normal blending mode. Select Preserve Appearance and Overprints to preserve overprints that don't interact with transparent objects. Overprints that interact with transparent objects are flattened.

Embed Fonts (For Other Applications) Embeds all fonts that contain appropriate permissions from the font vendor. Embedding fonts ensures that the original font is displayed and printed if the file is placed into another application, such as Adobe InDesign. However, if the file is opened in Illustrator on a computer that does not have the font installed, the font will be faux or substituted. This is to prevent illegal use of the embedded font.

Note: Selecting the Embed Fonts option increases the size of the saved file.

Include Linked Files Embeds files that are linked to the artwork.

Include Document Thumbnails Creates a thumbnail image of the artwork. The thumbnail is displayed in the Illustrator Open and Place dialog boxes.

Include CMYK PostScript In RGB Files Allows RGB color documents to be printed from applications that do not support RGB output. When the EPS file is reopened in Illustrator, the RGB colors are preserved.

Compatible Gradient And Gradient Mesh Printing Enables older printers and PostScript devices to print gradients and gradient meshes by converting gradient objects to JPEG format. Selecting this option can slow printing on printers that don't have problems with gradients.

Adobe PostScript® Determines what level of PostScript is used to save the artwork. PostScript Language Level 2 represents color as well as grayscale vector and bitmap images, and supports RGB, CMYK, and CIE-based color models for both vector and bitmap graphics. PostScript Language Level 3 provides additional functionality to Language Level 2, including the ability to print mesh objects when printing to a PostScript® 3™ printer. Because printing to PostScript Language Level 2 devices converts gradient mesh objects to bitmap images, it is preferable to print artwork that contains gradient mesh objects to a PostScript 3 printer.

More Help topics

[“Preview which areas of artwork will be flattened”](#) on page 435

[“Printing and saving transparent artwork”](#) on page 431

[“About overprinting”](#) on page 438

Save in SVG format

SVG is a vector format that produces high-quality, interactive web graphics. There are two versions of the SVG formats: SVG and Compressed SVG (SVGZ). SVGZ can reduce file sizes by 50% to 80%; however, you cannot edit SVGZ files using a text editor.

When you save artwork in an SVG format, mesh objects are rasterized. In addition, images that have no alpha channel are converted to the JPEG format. Images with an alpha channel are converted to the PNG format. If your document contains multiple artboards and you save to SVG, the active artboard is preserved. You cannot save individual artboards as separate SVG files.

For a video on creating mobile content in Illustrator, see www.adobe.com/go/vid0207.

- 1 If the artwork contains any SVG effects, select each item to which an SVG effect has been applied, and move the effect to the bottom of the Appearance panel (just above the Opacity entry). If other effects follow an SVG effect, the SVG output will consist of a raster object. In addition, if the artwork contains multiple artboards, select the artboard you want to export.
- 2 Choose File > Save As or File > Save A Copy.
- 3 Type a filename, and choose a location for the file.
- 4 Choose SVG (*.SVG) or SVG Compressed (*.SVGZ) as the file format, and click Save.
- 5 In the SVG Options dialog box, set the desired options and click OK:

SVG Profiles Specifies the SVG XML Document Type Definition for the exported file.

- **SVG 1.0 and SVG 1.1** Suitable for SVG files that will be viewed on a desktop computer. SVG 1.1 is the full version of the SVG specification, of which SVG Tiny 1.1, SVG Tiny 1.1 Plus, and SVG Basic 1.1 are subsets.
- **SVG Basic 1.1** Suitable for SVG files that will be viewed on medium powered devices, such as handheld devices. Keep in mind that not all handhelds support the SVG Basic profile. As a result, selecting this option does not

guarantee that the SVG file will be viewable on all handhelds. SVG Basic does not support nonrectangular clipping and some SVG filter effects.

- **SVG Tiny 1.1 and SVG Tiny 1.1+** Suitable for SVG files that will be viewed on small devices, such as mobile phones. Keep in mind that not all mobile phones support the SVG Tiny and SVG Tiny Plus profiles. As a result, selecting either of these options does not guarantee that the SVG file will be viewable on all small devices.
- **SVG Tiny 1.2** Suitable for SVG files that will be viewed on a variety of devices ranging from PDAs and mobile phones to laptops and desktop computers.

SVG Tiny does not support gradients, transparency, clipping, masks, symbols, patterns, underline text, strike through text, vertical text, or SVG filter effects. SVG Tiny Plus includes the ability to display gradients and transparency, but does not support clipping, masks, symbols, or SVG filter effects.

 For additional information on SVG profiles, see the SVG specification on the World Wide Web Consortium (W3C) website (www.w3.org).

Font Type Specifies how fonts are exported:

- **Adobe CEF** Uses font hinting for better rendering of small fonts. This font type is supported by the Adobe SVG Viewer but may not be supported by other SVG viewers.
- **SVG** Does not use font hinting. This font type is supported by all SVG viewers.
- **Convert To Outlines** Converts type to vector paths. Use this option to preserve the visual appearance of type in all SVG Viewers.

Font Subsetting Controls which *glyphs* (characters of a particular font) are embedded in the exported SVG file. Choose None from the Subsetting menu if you can rely on the necessary fonts being installed on end-user systems. Choose Only Glyphs Used to include only glyphs for text that exists in the current artwork. The other values (Common English, Common English + Glyphs Used, Common Roman, Common Roman + Glyphs Used, All Glyphs) are useful when the textual content of the SVG file is dynamic (such as server-generated text or user-interactive text).

Image Location Determines whether raster images are embedded directly in the file or linked to the exported JPEG or PNG images from the original Illustrator file. Embedding images increases file size but ensures that rasterized images will always be available.

Preserve Illustrator Editing Capabilities Preserves Illustrator-specific data by embedding an AI file in the SVG file (resulting in a larger file size). Select this option if you plan to reopen and edit the SVG file in Illustrator. Note that if you make manual changes to the SVG data, the changes are not reflected when you reopen the file. This is because Illustrator reads the AI portion of the file, not the SVG portion.

CSS Properties Determines how style attributes are saved in the SVG code. The default method, Presentation Attributes, applies properties at the highest point in the hierarchy, which allows the most flexibility for specific edits and transformations. The Style Attributes method creates the most readable files but may increase the file size. Choose this method if the SVG code will be used in transformations, for example, transformations using Extensible Stylesheet Language Transformation (XSLT). The Style Attributes <Entity References> method results in faster rendering times and reduced SVG file size. The Style Elements method is used when sharing files with HTML documents. By selecting Style Elements, you can then modify the SVG file to move a style element into an external style sheet file that is also referenced by the HTML file; however, the Style Elements option also results in slower rendering speeds.

Decimal Places Specifies the precision of vector data in the SVG file. You can set a value of 1–7 decimal places. A higher value results in a larger file size and increased image quality.

Encoding Determines how characters are encoded in the SVG file. UTF (Unicode Transformation Format) encoding is supported by all XML processors. (UTF-8 is an 8-bit format; UTF-16 is a 16-bit format.) ISO 8859-1 and UTF-16 encoding do not preserve file metadata.

Optimize For Adobe SVG Viewer Maintains the highest level of Illustrator data while still allowing the SVG file to be manually edited. Select this option to take advantage of faster rendering for features such as SVG filter effects.

Include Adobe Graphics Server Data Includes all information needed for variable substitution in the SVG file.

Include Slicing Data Includes slice locations and optimization settings.

Include XMP Includes XMP metadata in the SVG file. Choose File > Info or use the Bridge Browser to enter metadata.

Output Fewer <tspan> Elements Allows Illustrator to ignore auto-kerning settings during export, which results in a file with fewer <tspan> elements. Select this option to create an SVG file that is more editable and compact. Deselect this option if maintaining the appearance of auto-kerned text is critical.

Use <textPath> Element For Text On Path Exports text on a path as a <textPath> element. However, note that the text may appear differently in the SVG Viewer than it does in Illustrator since this export mode will not always be able to maintain visual parity. In particular, overflow text will be visible in the SVG Viewer.

Show SVG Code Displays the code for the SVG file in a browser window.

Web Preview Displays the SVG file in a browser window.

Device Central Opens the file in Device Central for previewing on a particular mobile phone or device.

More Help topics

[“About SVG”](#) on page 392

[“Using Adobe Device Central with Illustrator”](#) on page 386

[“About metadata”](#) on page 302

[“About data-driven graphics”](#) on page 455

Save artwork for Microsoft Office

The Save For Microsoft Office command lets you create a PNG file that you can use in Microsoft Office applications.

- 1 Choose File > Save For Microsoft Office.
- 2 In the Save For Office dialog box, select a location for the file, enter a filename, and click Save.

 *If you want to customize PNG settings, such as for resolution, transparency, and background color, use the Export command instead of the Save For Microsoft Office command. You can also save artwork in PNG format using the Save For Web & Devices command.*

Changing vector graphics to bitmap images

About rasterization

Rasterization is the process of changing a vector graphic to a bitmap image. During rasterization, Illustrator converts the graphic's paths into pixels. The rasterization options you set determine the size and other characteristics of the resulting pixels.

You can rasterize individual vector objects using the Object > Rasterize command or the Rasterize effect. You can also rasterize an entire document by exporting it to a bitmap format, such as JPEG, GIF, or TIFF.

More Help topics

[“About raster effects”](#) on page 368

[“Rasterization options”](#) on page 369

Rasterize a vector object

- 1 Select one or more objects.
- 2 Do one of the following:
 - To permanently rasterize the objects, choose Object > Rasterize.
 - To create the appearance of rasterization without changing the objects’ underlying structure, choose Effect > Rasterize.
- 3 Set rasterization options (see [“Rasterization options”](#) on page 369), and click OK.

Exporting artwork

Export artwork

- 1 Choose File > Export.
- 2 Select a location for the file, and enter a filename.
- 3 Select a format from the Save As Type (Windows) or Format (Mac OS) pop-up menu.
- 4 Click Save (Windows) or Export (Mac OS).

For a video on exporting content from Illustrator, including an overview on different formats and when you should use them, see www.adobe.com/go/vid0062.

More Help topics

[“About saving artwork”](#) on page 277

File formats for exporting artwork

Note: You can export multiple artboards only to the following formats: SWF, JPEG, PSD, PNG, and TIFF.

AutoCAD Drawing and AutoCAD Interchange File (DWG and DXF) AutoCAD Drawing is the standard file format for saving vector graphics created in AutoCAD. AutoCAD Interchange File is a drawing interchange format for exporting AutoCAD drawings to or importing drawings from other applications. For more information, see [“AutoCAD export options”](#) on page 285.

Note: By default, white strokes or fills in Illustrator artwork are exported to the AutoCAD formats as black strokes or fills; and black strokes or fills in Illustrator are exported to the AutoCAD format as white.

BMP A standard Windows image format. You can specify a color model, resolution, and anti-alias setting for rasterizing the artwork, as well as a format (Windows or OS/2) and a bit depth to determine the total number of colors (or shades of gray) that the image can contain. For 4-bit and 8-bit images using Windows format, you can also specify RLE compression.

Enhanced Metafile (EMF) Widely used by Windows applications as an interchange format for exporting vector graphics data. Illustrator may rasterize some vector data when exporting artwork to EMF format.

JPEG (Joint Photographic Experts Group) Commonly used to save photographs. JPEG format retains all color information in an image but compresses file size by selectively discarding data. JPEG is a standard format for displaying images over the web. For more information, see “[JPEG export options](#)” on page 287. You can also save an image as a JPEG file using the Save For Web & Devices command.

Note: Artifacts, such as wave-like patterns or blocky areas of banding, are added to a file each time you save the file as a JPEG. Always save JPEG files from the original image, not from a previously saved JPEG.

Macintosh PICT Used with Mac OS graphics and page-layout applications to transfer images between applications. PICT is especially effective at compressing images with large areas of solid color.

Flash (SWF) A vector-based graphics format for interactive, animated web graphics. You can export artwork to the Flash (SWF) format for use in web design, and view the artwork in any browser equipped with the Flash Player plug-in. For more information, see “[Flash export options](#)” on page 285. You can also save an image as an SWF file using the Save For Web & Devices command (see SWF optimization options (Illustrator)), and you can export text as Flash Dynamic or Input text (see “[Tag text for export to Flash](#)” on page 346). In addition to exporting artwork in Flash format, you can copy Illustrator artwork and paste it into Flash. The fidelity of artwork is maintained across the clipboard.

You can create vector artwork for Flex skins in Adobe Illustrator and export it using the Create Flex Skin script. Flex skins and extensions for Illustrator are available from www.adobe.com/go/flex_skinning_en. For more information about Flex skins and Flex Builder, see the Flex documentation on Adobe.com.

Photoshop (PSD) The standard Photoshop format. If your artwork contains data that cannot be exported to Photoshop format, Illustrator preserves the appearance of the artwork by merging the layers in the document or by rasterizing the artwork. As a result, there may be times when layers, sublayers, compound shapes, and editable text are not preserved in the Photoshop file, even though you selected the appropriate export option. For more information, see “[Photoshop export options](#)” on page 288.

PNG (Portable Network Graphics) Used for lossless compression and for display of images on the web. Unlike GIF, PNG supports 24-bit images and produces background transparency without jagged edges; however, some web browsers do not support PNG images. PNG preserves transparency in grayscale and RGB images. For more information, see “[PNG export options](#)” on page 289. You can also save an image as a PNG file using the Save For Web & Devices command.

Targa (TGA) Designed for use on systems that use the Truevision® video board. You can specify a color model, resolution, and anti-alias setting for rasterizing the artwork, as well as a bit depth to determine the total number of colors (or shades of gray) that the image can contain.

Text Format (TXT) Used to export text in an illustration to a text file. (See “[Export text to a text file](#)” on page 346.)

TIFF (Tagged-Image File Format) Used to exchange files between applications and computer platforms. TIFF is a flexible bitmap image format supported by most paint, image-editing, and page-layout applications. Most desktop scanners can produce TIFF files. For more information, see “[TIFF export options](#)” on page 289.

Windows Metafile (WMF) An intermediate exchange format for 16-bit Windows applications. WMF format is supported by almost all Windows drawing and layout programs. However, it has limited vector graphics support, and wherever possible, EMF format should be used in place of WMF format.

More Help topics

“[About saving artwork](#)” on page 277

“[Export artwork](#)” on page 283

AutoCAD export options

When you export artwork to either DXF or DWG format, you can set the following options:

AutoCAD Version Specifies the version of AutoCAD that supports the exported file.

Scale Enter values for Scale Units to specify how Illustrator interprets length data when writing the AutoCAD file.

Scale Lineweights Scales the lineweights, along with the rest of the drawing, in the exported file.

Number of Colors Determines the color depth of the exported file.

Raster File Format Specifies whether images and objects that are rasterized during export are saved in PNG or JPEG format. Only PNG supports transparency; if you need to preserve appearance to the maximum extent possible, choose PNG.

Preserve Appearance Select if you need the appearance to be maintained and don't need to make edits to the exported file. Selecting this option may lead to a significant loss of editability. For example, text may be outlined and effects will be rasterized. You can select this option or Maximum Editability, but not both.

Maximum Editability Select if the need to edit the file in AutoCAD outweighs the need for maintaining appearance. This option may lead to significant loss of appearance, especially if you've applied style effects. You can select this option or Preserve Appearance, but not both.

Export Selected Art Only Exports only the artwork in the file that is selected at the time of export. If no artwork is selected, a blank file is exported.

Alter Paths For Appearance Changes the paths in AutoCAD to maintain the original appearance, if necessary. For example, if during the export, a path overlaps other objects and changes their appearance, this option alters the path to maintain the objects' appearance.

Outline Text Converts all text to paths before export to maintain appearance. Illustrator and AutoCAD may interpret text attributes differently. Select this option to maintain maximum visual fidelity (at the cost of editability). If you need to edit the text in AutoCAD, don't select this option.

Flash export options

When you export artwork to SWF format, you can set the following Basic and Advanced options. You can export multiple artboards to SWF format. For a video on exporting SWF files from Illustrator, see www.adobe.com/go/vid0214. (For a video on importing Illustrator files into Flash, see www.adobe.com/go/vid0197, and for a video on using Flash and Illustrator together, see www.adobe.com/go/lrvid4099_xp.)

At any time, you can click Web Preview to preview the file in the default web browser (Flash Player browser plug-in should be installed for the browser), or click Device Central to preview the file in Flash Player on a particular mobile phone or device.

***Note:** If your goal is to bring Illustrator artwork into a Flash document, you can simply paste it in. All paths, strokes, gradients, text (specify Flash Text), masks, effects (such as drop shadow on text), and symbols are maintained. In addition, you can specify how layers are imported when pasting: as Flash layers, frames, or graphic symbols. For a video on importing and copying and pasting between web applications, see www.adobe.com/go/vid0193.*

Before you click Save (Windows) or Export (Mac OS) in the Export dialog box, specify how to export multiple artboards. If you want to export artboards as separate SWF files, select Use Artboards in the Export dialog box. To export only a range of artboards, specify the range. Then click Save (Windows) or Export (Mac OS) and specify the following options:

Preset Specifies the preset option settings file to use for exporting. If you change the default settings, this option changes to Custom. You can save a custom option settings as a new preset for reuse with other files. To save option settings as a preset, click Save Preset.

Export As Specifies how to convert Illustrator layers:

- **AI File To SWF File** Exports the artwork to a single frame. Select this option to preserve layer clipping masks.
- **AI Layers To SWF Frames** Exports the artwork on each layer to a separate SWF frame, creating an animated SWF.
- **AI Layers To SWF Files** Exports the artwork on each layer to a separate SWF file. The result is multiple SWF files, each containing a single frame with the artwork from a single Illustrator layer.
- **AI Layers To SWF Symbols** Converts the artwork on each layer to a symbol and exports it to a single SWF file. AI layers are exported as SWF Movie Clip symbols. The symbols are named using their corresponding layer names. For a video on using symbols effectively between Illustrator and Flash, see www.adobe.com/go/vid0198.
- **AI Artboards To SWF Files** Exports each of the selected artboards to a separate SWF file. This is the only option available when you choose to preserve multiple artboards in the Save As dialog box. If you save a preset with this option selected, you can use that saved preset only on files with multiple artboards.

Version Specifies the version of Flash Player for browsing imported files. The Compress File option isn't available in Flash version 5 and earlier. Dynamic Text and Input Text aren't available in version 3 and earlier.

Clip To Artboard Size Exports the Illustrator artwork within the selected artboard's borders to the SWF file. Any artwork outside the borders will be clipped off. This option is checked and disabled when exporting multiple artboards.

Preserve Appearance Select Preserve Appearance to flatten artwork to a single layer before export. Selecting this option limits the editability of the file.

Compress File Compresses the SWF data, resulting in a smaller file size. Note that Flash players prior to Flash Player 6 can't open or display compressed files. Don't use this option if you're not sure what version of the Flash player the file will be viewed on.

Export Symbols In The Panel Exports all the symbols in the Symbols panel. If a symbol doesn't have an active instance in the artwork, the symbol isn't included in the exported frames; however, it is available for use in the Flash Symbol Library within the Flash Authoring environment.

Export Text As Outlines Converts type to vector paths. Use this option to preserve the visual appearance of type in all Flash players. If you prefer to have maximum text editing ability, deselect this option. (For a video on using text effectively between Flash and Illustrator, see www.adobe.com/go/vid0199.)

Ignore Kerning Information For Text Exports text without the kerning values.

Include Metadata Exports the metadata associated with the file. Exported XMP information is minimized to keep file size small. For example, thumbnails aren't included.

Protect From Import Prohibits users from modifying the exported SWF file.

Password Type a password to protect the file from being opened by unauthorized users or in applications other than Adobe Flash.

Curve Quality Determines the accuracy of the Bezier curves. A lower value decreases the exported file size with a slight loss of curve quality. A higher value increases the accuracy of the Bezier curve reproduction, but results in a larger file size.

Background Color Specifies a background color for the exported SWF file.

Local Playback Security Specifies whether you want the file to access only local files or network files during playback.

To specify Advanced options, click Advanced and specify any of the following:

Image Format Determines how the artwork is compressed. Lossless compression maintains the highest image quality but creates a large SWF file. Lossy (JPEG) compression creates a smaller SWF file but adds artifacts to the image. Select Lossless if you intend to continue to work on the file (or files) in Flash; select Lossy if you're exporting the final SWF file.

JPEG Quality Specifies the amount of detail in the exported image. The higher the quality, the larger the file size. (This option is available only if you choose Lossy compression.)

Method Specifies the type of JPEG compression that is used. Baseline (Standard) applies the standard type of compression, while Baseline Optimized applies additional optimization. (These options are available only if you choose Lossy compression.)

Resolution Adjusts the screen resolution for bitmap images. Resolution for exported SWF files can be 72 to 600 pixels per inch (ppi). Higher resolution values result in better image quality but larger file sizes.

Frame Rate Specifies the rate at which the animation will be played in Flash Player. (This option is available only for AI Layers To SWF Frames.)

Looping Causes the animation to loop continuously, rather than play once and then stop, when played in Flash Player. (This option is available only for AI Layers To SWF Frames.)

Animate Blends Specifies whether or not to animate blended objects. Selecting this option produces the same results as manually releasing blended objects to layers before you export. Blends are always animated from start to end irrespective of the layer order.

If you select Animate Blends, select a method for exporting the blend:

- **In Sequence** Exports each object in the blend to a separate frame in the animation.
- **In Build** Builds up a cumulative sequence of objects in the animation frames. For example, the bottommost object in the blend appears in each of the frames, and the topmost object in the blend appears only in the last frame.

Layer Order Determines the timeline of the animation. Select Bottom Up to export layers starting with the bottommost layer in the Layers panel. Select Top Down to export layers starting with the topmost layer in the Layers panel. (This option is available only for AI Layers To SWF Frames.)

Export Static Layers Specifies one or more layers or sublayers to be used as static content in all the exported SWF Frames. Content from the selected layers or sublayers will be present as background art in every exported SWF frame. (This option is only available for AI Layers To SWF Frames.)

More Help topics

[“About Flash graphics”](#) on page 395

[“Create Flash animations”](#) on page 396

[“Using multiple artboards”](#) on page 31

[“Working with Illustrator and Flash”](#) on page 396

JPEG export options

If your document contains multiple artboards, specify how to export the artboards before you click Save (Windows) or Export (Mac OS) in the Export dialog box. To export each artboard as a separate JPEG file, select Use Artboards in the Export dialog box. To export only a range of artboards, specify the range. Then click Save (Windows) or Export (Mac OS) and specify the following options:

Quality Determines the quality and size of the JPEG file. Choose an option from the Quality menu or enter a value between 0 and 10 in the Quality text box.

Color Model Determines the color model of the JPEG file.

Method and Scans Select Baseline (“Standard”) to use a format recognized by most web browsers, Baseline Optimized for optimized color and a slightly smaller file size, Progressive to display a series of increasingly detailed scans (you

specify how many) as the image downloads. Baseline Optimized and Progressive JPEG images are not supported by all web browsers.

Depth Determines the resolution of the JPEG file. Choose Custom to specify a resolution.

Anti-Alias Removes jagged edges in the artwork by supersampling it. Deselecting this option helps maintain the hard edges of line art when it is rasterized.

Imagemap Generates code for image maps. If you select this option, select Client-side (.html) or Server-side (.map) to determine the type of file that is generated.

Embed ICC Profiles Saves ICC profiles in the JPEG file.

More Help topics

[“About colors in digital graphics”](#) on page 113

Photoshop export options

If your document contains multiple artboards, specify how to export the artboards before you click Save (Windows) or Export (Mac OS) in the Export dialog box. To export each artboard as a separate PSD file, select Use Artboards in the Export dialog box. To export only a range of artboards, specify the range. Then click Save (Windows) or Export (Mac OS) and specify the following options:

Color Model Determines the color model of the exported file. Exporting a CMYK document as RGB, or vice versa, may cause unexpected changes in the appearance of transparent areas, especially those that include blending modes. If you change the color model, you must export the artwork as a flat image (the Write Layers option isn't available).

Resolution Determines the resolution of the exported file.

Flat Image Merges all layers and exports the Illustrator artwork as a rasterized image. Choosing this option preserves the visual appearance of the artwork.

Write Layers Exports groups, compound shapes, nested layers, and slices as separate, editable Photoshop layers. Nested layers that are more than five levels deep are merged into a single Photoshop layer. Select Maximum Editability to export transparent objects (that is, objects with an opacity mask, a constant opacity less than 100%, or a blending mode other than Normal) as live, editable Photoshop layers.

Preserve Text Editability Exports horizontal and vertical point type in layers (including nested layers up to five levels deep) to editable Photoshop type. If doing so compromises the appearance of the artwork, you can deselect this option to rasterize the text instead.

Maximum Editability Writes each top-level sublayer to a separate Photoshop layer if doing so doesn't compromise the appearance of the artwork. Top-level layers become Photoshop layer sets. Transparent objects remain editable transparent objects. Also creates a Photoshop shape layer for each compound shape in a top-level layer if doing so doesn't compromise the appearance of the artwork. To write compound shapes with solid strokes, change the Join type to Round. Whether or not you select this option, all layers over 5 levels deep are merged into a single Photoshop layer.

Note: Illustrator cannot export compound shapes that have graphic styles, dashed strokes, or brushes applied to them. Such compound shapes become rasterized.

Anti-Alias Removes jagged edges in the artwork by supersampling it. Deselecting this option helps maintain the hard edges of line art when it's rasterized.

Embed ICC Profiles Creates a color-managed document.

More Help topics

[“Image resolution guidelines for final output”](#) on page 272

[“About colors in digital graphics”](#) on page 113

[“Stroke an object”](#) on page 151

PNG export options

If your document contains multiple artboards, specify how to export the artboards before you click Save (Windows) or Export (Mac OS) in the Export dialog box. To export each artboard as a separate PNG file, select Use Artboards in the Export dialog box. To export only a range of artboards, specify the range. Then click Save (Windows) or Export (Mac OS) and specify the following options:

Resolution Determines the resolution of the rasterized image. Higher resolution values result in better image quality but larger file sizes.

Note: Some applications open PNG files at 72 ppi, regardless of the resolution you specify. In such applications, the dimensions of the image will be altered. (For example, artwork saved at 150 ppi will be over twice as large as artwork saved at 72 ppi.) Therefore, only change the resolution when you know the target application supports non-72-ppi resolutions.

Color Specifies a color for filling transparency. Choose Transparent to preserve transparency, White to fill transparency with white, Black to fill transparency with black, or Other to select another color for filling transparency.

Anti-Alias Removes jagged edges in the artwork by supersampling it. Deselecting this option helps maintain the hard edges of line art when it is rasterized.

Interlaced Displays low-resolution versions of the image as the file downloads in a browser. Interlacing makes download time seem shorter, but also increases file size.

More Help topics

[“Image resolution guidelines for final output”](#) on page 272

TIFF export options

If your document contains multiple artboards, specify how to export the artboards before you click Save (Windows) or Export (Mac OS) in the Export dialog box. To export each artboard as a separate TIFF file, select Use Artboards in the Export dialog box. To export only a range of artboards, specify the range. Then click Save (Windows) or Export (Mac OS) and specify the following options:

Color Model Determines the color model of the exported file.

Resolution Determines the resolution of the rasterized image. Higher resolution values result in better image quality but larger file sizes.

Anti-Alias Removes jagged edges in the artwork by supersampling it. Deselecting this option helps maintain the hard edges of line art when it is rasterized.

LZW Compression Applies LZW compression, a lossless compression method that does not discard detail from the image. Select this option to produce a smaller file.

Byte Order Determines the appropriate sequence of bytes for writing the image file, based on the platform you choose. Illustrator and most recent applications can read files using the byte order for either platform. However, if you don't know what kind of program the file may be opened in, select the platform on which the file will be read.

Embed ICC Profiles Creates a color-managed document.

More Help topics

[“Image resolution guidelines for final output”](#) on page 272

[“About colors in digital graphics”](#) on page 113

Creating Adobe PDF files

About Adobe PDF

Portable Document Format (PDF) is a universal file format that preserves the fonts, images, and layout of source documents created on a wide range of applications and platforms. Adobe PDF is the standard for the secure, reliable distribution and exchange of electronic documents and forms around the world. Adobe PDF files are compact and complete, and can be shared, viewed, and printed by anyone with free Adobe Reader® software.

Adobe PDF is highly effective in print publishing workflows. By saving a composite of your artwork in Adobe PDF, you create a compact, reliable file that you or your service provider can view, edit, organize, and proof. Then, at the appropriate time in the workflow, your service provider can either output the Adobe PDF file directly, or process it using tools from various sources for such post-processing tasks as preflight checks, trapping, imposition, and color separation.

When you save in Adobe PDF, you can choose to create a PDF/X-compliant file. PDF/X (Portable Document Format Exchange) is a subset of Adobe PDF that eliminates many of the color, font, and trapping variables that lead to printing problems. PDF/X may be used wherever PDFs are exchanged as digital masters for print production—whether at the creation or output stage of the workflow, as long as the applications and output devices support PDF/X.

Adobe PDFs can solve the following problems associated with electronic documents:

Common problem	Adobe PDF solution
Recipients can't open files because they don't have the applications used to create the files.	Anyone, anywhere can open a PDF. All you need is the free Adobe Reader software.
Combined paper and electronic archives are difficult to search, take up space, and require the application in which a document was created.	PDFs are compact and fully searchable, and can be accessed at any time using Reader. Links make PDFs easy to navigate.
Documents appear incorrectly on handheld devices.	Tagged PDFs allow text to reflow for display on mobile platforms such as Palm OS®, Symbian™, and Pocket PC® devices.
Documents with complex formatting are not accessible to visually impaired readers.	Tagged PDFs contain information on content and structure, which makes them accessible on-screen readers.

Create Adobe PDF files

You can create different types of PDF files from within Illustrator. You can create multipage PDFs, layered PDFs, and PDF/x-compliant files. Layered PDFs allow you to save one PDF with layers that can be used in different contexts. PDF/X-compliant files ease the burden of color, font, and trapping issues.

For a video on creating PDFs from Creative Suite applications, see www.adobe.com/go/vid0209. For a video on exporting to PDF 1.7 for review or prepress purposes, see www.adobe.com/go/vid0210. For a video on creating interactive PDFs, see www.adobe.com/go/vid0211.

More Help topics

[“Adobe PDF presets”](#) on page 292

[“Setting Adobe PDF options”](#) on page 295

[“Color management and PDF/X options for PDF”](#) on page 299

Create an Adobe PDF

- 1 Choose File > Save As or File > Save A Copy.
- 2 Type a filename, and choose a location for the file.
- 3 Choose Adobe PDF (*.PDF) as the file format, and click Save.
- 4 Either choose a preset from the Adobe PDF Preset menu, or select a category from the list on the left of the dialog box and then customize the options.
- 5 Click Save PDF.



To reset options to the default, hold down Alt (Windows) or Option (Mac OS) and click Reset.

Create a multiple-page Adobe PDF

- 1 Create multiple artboards in a document.
- 2 Choose File > Save As, and select Adobe PDF for Save As Type.
- 3 Do one of the following:
 - To save all of the artboards to one PDF, select All.
 - To save a subset of the artboards to one PDF, select Range, and type the range of artboards.
- 4 Click Save, and set additional PDF options in the Save Adobe PDF dialog box.
- 5 Click Save PDF.

Create a layered Adobe PDF

Adobe InDesign and Adobe Acrobat both provide features for changing the visibility of layers in an Adobe PDF file. By saving a layered PDF file in Illustrator, you allow your illustration to be used in different contexts. For example, rather than creating multiple versions of the same illustration for a multilanguage publication, you can create one PDF file that contains text for all languages.

- 1 Set up your illustration so that the adjustable elements (those you want to show and hide) are in separate top-level layers, not nested within sublayers.

For example, if you’re creating an illustration to be repurposed for multiple languages, put the text for each language in a different top-level layer.
- 2 Save the file in Adobe PDF format.
- 3 In the Save Adobe PDF dialog box, choose Acrobat 8 (1.7) or Acrobat 7 (1.6) for Compatibility.
- 4 Select Create Acrobat Layers from Top-Level Layers, set additional PDF options, and click Save PDF.

Create an Adobe PDF/X-compliant file

PDF/X (Portable Document Format Exchange) is an ISO standard for graphic content exchange that eliminates many of the color, font, and trapping variables that lead to printing problems. Illustrator supports PDF/X-1a (for a CMYK workflow), PDF/X-3 (for a color-managed workflow), and PDF/X-4 (for a color-managed workflow with added support for preserving transparency as live rather than flattened).

You can create a PDF/X-compliant file during the process of saving a PDF file.

- 1 In the Save Adobe PDF dialog box, choose a PDF/X preset, or choose a PDF/X format from the Standard menu.
- 2 Click Output on the left side of the Save Adobe PDF dialog box, and set PDF/X options.

Create compact PDF documents

Illustrator CS5 provides the option to save a document in the smallest file size. To generate a compact PDF from Illustrator, do the following:

- 1 Click File > Save As and select PDF.
- 2 In the Save Adobe PDF dialog box, select the Smallest File Size option from Adobe PDF Preset.

Make sure that you deselect the Preserve Illustrator Editing Capabilities check box to avoid saving the Illustrator resources along with the document.

Adobe PDF presets

A PDF *preset* is a group of settings that affect the process of creating a PDF. These settings are designed to balance file size with quality, depending on how the PDF will be used. Most predefined presets are shared across Adobe Creative Suite components, including InDesign, Illustrator, Photoshop, and Acrobat. You can also create and share custom presets for your unique output requirements.

A few of the presets listed below are not available until you move them—as needed—from the Extras folder (where they are installed by default) to the Settings folder. Typically, the Extras and Settings folders are found in (Windows Vista and Windows 7) ProgramData\Adobe\AdobePDF, (Windows XP) Documents and Settings\All Users\Application Data\Adobe\Adobe PDF, or (Mac OS) Library/Application Support/Adobe PDF. Some presets are not available in some Creative Suite components.

The custom settings are found in (Windows XP) Documents and Settings/[username]/Application Data/Adobe/Adobe PDF/Settings, (Windows Vista and Windows 7) Users/[username]/AppData/Roaming/Adobe/Adobe PDF/Settings, or (Mac OS) Users/[username]/Library/Application Support/Adobe/Adobe PDF/Settings.



Review your PDF settings periodically. The settings do not automatically revert to the default settings. Applications and utilities that create PDFs use the last set of PDF settings defined or selected.

High Quality Print Creates PDFs for quality printing on desktop printers and proofing devices. This preset uses PDF 1.4, downsamples color and grayscale images to 300 ppi and monochrome images to 1200 ppi, embeds subsets of all fonts, leaves color unchanged, and does not flatten transparency (for file types capable of transparency). These PDFs can be opened in Acrobat 5.0 and Acrobat Reader 5.0 and later. In InDesign, this preset also creates tagged PDFs.

Illustrator Default (Illustrator only) Creates a PDF in which all Illustrator data is preserved. PDFs created with this preset can be reopened in Illustrator without any loss of data.

Oversized Pages (Acrobat only) Creates PDFs suitable for viewing and printing of engineering drawings larger than 200 x 200 inches. These PDFs can be opened in Acrobat and Reader 7.0 and later.

PDF/A-1b: 2005 (CMYK and RGB) (Acrobat only) Used for long-term preservation (archival) of electronic documents. PDF/A-1b uses PDF 1.4 and converts all colors to either CMYK or RGB, depending on which standard you choose. These PDFs can be opened in Acrobat and Reader versions 5.0 and later.

PDF/X-1a (2001 and 2003) PDF/X-1a requires all fonts to be embedded, the appropriate marks and bleeds to be specified, and color to appear as CMYK, spot colors, or both. Compliant files must contain information describing the printing condition for which they are prepared. PDF files created with PDF/X-1a compliance can be opened in Acrobat 4.0 and Acrobat Reader 4.0 and later.

PDF/X-1a uses PDF 1.3, downsamples color and grayscale images to 300 ppi and monochrome images to 1200 ppi, embeds subsets of all fonts, creates untagged PDFs, and flattens transparency using the High Resolution setting.

Note: The PDF/X1-a:2003 and PDF/X-3 (2003) presets are placed on your computer during installation but are not available until you move them from the Extras folder to the Settings folder.

PDF/X-3 This preset creates a PDF based on the ISO standard PDF/X-3:2002. The PDF created in this setting can be opened in Acrobat 4.0 and Acrobat Reader 4.0 or later.

PDF/X-4 (2008) This preset creating ISO PDF/X-4:2008 files supports live transparency (transparency is not flattened) and ICC color management. PDF files exported with this preset are in PDF 1.4 format. Images are downsampled and compressed and fonts are embedded in the same manner as with the PDF/X-1a and PDF/X-3 settings. You can create PDF/X-4:2008 compliant PDF files directly from Creative Suite 4 and 5 components including Illustrator, InDesign, and Photoshop. Acrobat 9 Pro provides facilities to validate and preflight PDF files for PDF/X-4:2008 compliance as well as convert non-PDF/X files to PDF/X-4:2008 if possible.

Adobe recommends PDF/X-4:2008 as the optimal PDF file format for reliable PDF print publishing workflows.

Press Quality Creates PDF files for high-quality print production (for example, for digital printing or for separations to an imagesetter or platesetter), but does not create files that are PDF/X-compliant. In this case, the quality of the content is the highest consideration. The objective is to maintain all the information in a PDF file that a commercial printer or print service provider needs in order to print the document correctly. This set of options uses PDF 1.4, converts colors to CMYK, downsamples color and grayscale images to 300 ppi and monochrome images to 1200 ppi, embeds subsets of all fonts, and preserves transparency (for file types capable of transparency).

These PDF files can be opened in Acrobat 5.0 and Acrobat Reader 5.0 and later.

Note: Before creating an Adobe PDF file to send to a commercial printer or print service provider, find out what the output resolution and other settings should be, or ask for a .joboptions file with the recommended settings. You might need to customize the Adobe PDF settings for a particular provider and then provide a .joboptions file of your own.

Rich Content PDF Creates accessible PDF files that include tags, hyperlinks, bookmarks, interactive elements, and layers. This set of options uses PDF 1.5 and embeds subsets of all fonts. It also optimizes files for byte serving. These PDF files can be opened in Acrobat 6.0 and Adobe Reader 6.0 and later. (The Rich Content PDF preset is in the Extras folder.)

Note: This preset was called eBook in earlier versions of some applications.

Smallest File Size Creates PDF files for displaying on the web, an intranet, or for email distribution. This set of options uses compression, downsampling, and a relatively low image resolution. It converts all colors to sRGB and embeds fonts. It also optimizes files for byte serving. For best results, avoid using this preset if you intend to print the PDF file.

These PDF files can be opened in Acrobat 5.0 and Acrobat Reader 5.0 and later.

Standard (Acrobat only) Creates PDF files to be printed to desktop printers or digital copiers, published on a CD, or sent to a client as a publishing proof. This set of options uses compression and downsampling to keep the file size down, but also embeds subsets of all (allowed) fonts used in the file, converts all colors to sRGB, and prints to a medium

resolution. Note that Windows font subsets are not embedded by default. PDF files created with this settings file can be opened in Acrobat 5.0 and Acrobat Reader 5.0 and later.

 For more information about shared PDF settings for Creative Suite components, see the PDF Integration Guide on the Creative Suite DVD.

Customize PDF presets

Although the default PDF presets are based on best practices, you may discover that your workflow, or perhaps your printer's workflow, requires specialized PDF settings that aren't available via any of the built-in presets. If this is the case, you or your service provider can create custom presets.

- 1 Choose Edit > Adobe PDF Presets.
- 2 Do one of the following:
 - To create a new preset, click New. If you want to base the new preset on an existing preset, select the preset first.
 - To edit an existing custom preset, select the preset and click Edit. (You cannot edit the default presets.)
 - To delete a preset, select it and click Delete.
 - To save a preset in a location other than the default Settings folder in the Adobe PDF folder, select it and click Save As. Specify a location and click Save.
- 3 Set the PDF options, and click OK.

Alternatively, you can create a custom preset when you save a PDF file by clicking Save Preset at the bottom of the Save Adobe PDF dialog box.

 If you want to share your presets with a colleague, select one or more presets and click Export. The presets are saved to a separate .joboptions file, which you can then transfer to your colleague via e-mail or over your computer network.

More Help topics

[“Setting Adobe PDF options”](#) on page 295

Load PDF presets

Illustrator comes with supplementary PDF presets (.joboptions) files. You may also receive custom PDF presets files from service providers and colleagues.

- ❖ To load PDF presets into all of your Creative Suite applications, do one of the following:
 - Double-click the .joboptions file.
 - Choose Edit > Adobe PDF Presets. Click Import, and select the .joboptions file you want to load.

Adobe PDF options

Adobe PDF options are divided into categories. Changing any option causes the name of the preset to change to Custom. The categories are listed on the left side of the Save Adobe PDF dialog box, with the exception of the Standard and Compatibility options, which are at the top of the dialog box.

Setting Adobe PDF options

Adobe PDF options are divided into categories. Changing any option causes the name of the preset to change to Custom. The categories are listed on the left side of the Save Adobe PDF dialog box, with the exception of the Standard and Compatibility options, which are at the top of the dialog box.

Standard Specifies a PDF standard for the file.

Compatibility Specifies a PDF version for the file.

General Specifies basic file options.

Compression Specifies if artwork should be compressed and downsampled, and if so, which method and settings to use.

Marks and Bleeds Specifies printer's marks and the bleed and slug areas. Although the options are the same as in the Print dialog box, the calculations are subtly different because PDF is not output to a known page size.

Output Controls how colors and PDF/X output intent profiles are saved in the PDF file.

Advanced Controls how fonts, overprinting, and transparency are saved in the PDF file.

Security Adds security to the PDF file.

Summary Displays a summary of the current PDF settings. To save the summary as an ASCII text file, click Save Summary.

About PDF/X standards

PDF/X standards are defined by the International Organization for Standardization (ISO). PDF/X standards apply to graphic content exchange. During PDF conversion, the file that is being processed is checked against the specified standard. If the PDF will not meet the selected ISO standard, a message appears, asking you to choose between canceling the conversion or going ahead with the creation of a non-compliant file. The most widely used standards for a print publishing workflow are several PDF/X formats: PDF/X-1a, PDF/X-3, and PDF/X-4.

Note: For more information on PDF/X, see the [ISO website](#) and the [Adobe website](#).

PDF compatibility levels

When you create PDFs, you need to decide which PDF version to use. You can change the PDF version by switching to a different preset or choosing a compatibility option when you save as PDF or edit a PDF preset.

Generally speaking, unless there's a specific need for backward compatibility, you should use the most recent version (in this case version 1.7). The latest version will include all the newest features and functionality. However, if you're creating documents that will be distributed widely, consider choosing Acrobat 5 (PDF 1.4) or Acrobat 6 (PDF 1.5) to ensure that all users can view and print the document.

The following table compares some of the functionality in PDFs created using the different compatibility settings.

Acrobat 4 (PDF 1.3)	Acrobat 5 (PDF 1.4)	Acrobat 6 (PDF 1.5)	Acrobat 7 (PDF 1.6) and Acrobat 8 and Acrobat 9 (PDF 1.7)
PDFs can be opened with Acrobat 3.0 and Acrobat Reader 3.0 and later.	PDFs can be opened with Acrobat 3.0 and Acrobat Reader 3.0 and later. However, features specific to later versions may be lost or not viewable.	Most PDFs can be opened with Acrobat 4.0 and Acrobat Reader 4.0 and later. However, features specific to later versions may be lost or not viewable.	Most PDFs can be opened with Acrobat 4.0 and Acrobat Reader 4.0 and later. However, features specific to later versions may be lost or not viewable.
Cannot contain artwork that uses live transparency effects. Any transparency must be flattened prior to converting to PDF 1.3.	Supports the use of live transparency in artwork. (The Acrobat Distiller feature flattens transparency.)	Supports the use of live transparency in artwork. (The Acrobat Distiller feature flattens transparency.)	Supports the use of live transparency in artwork. (The Acrobat Distiller feature flattens transparency.)
Layers are not supported.	Layers are not supported.	Preserves layers when creating PDFs from applications that support the generation of layered PDF documents, such as Illustrator CS and later or InDesign CS and later.	Preserves layers when creating PDFs from applications that support the generation of layered PDF documents, such as Illustrator CS and later or InDesign CS and later.
DeviceN color space with 8 colorants is supported.	DeviceN color space with 8 colorants is supported.	DeviceN color space with up to 31 colorants is supported.	DeviceN color space with up to 31 colorants is supported.
Multibyte fonts can be embedded. (Distiller converts the fonts when embedding.)	Multibyte fonts can be embedded.	Multibyte fonts can be embedded.	Multibyte fonts can be embedded.
40-bit RC4 security supported.	128-bit RC4 security supported.	128-bit RC4 security supported.	128-bit RC4 and 128-bit AES (Advanced Encryption Standard) security supported.

General options for PDF

You can set the following options in the General section of the Save Adobe PDF dialog box:

Description Displays the description from the selected preset, and provides a place for you to edit the description. You can paste a description from the clipboard. Editing the description of a preset appends the word “(modified)” to the preset name. Conversely, changing the settings in a preset prepends the description with “[Based on <Current Preset Name>].”

Preserve Illustrator Editing Capabilities Saves all Illustrator data in the PDF file. Select this option if you want to be able to reopen and edit the PDF file in Adobe Illustrator.

Important: *The Preserve Illustrator Editing Capabilities option counteracts aggressive compression and downsampling. If file size is a concern, deselect this option.*

Embed Page Thumbnails Creates a thumbnail image of artwork. The thumbnail is displayed in the Illustrator Open or Place dialog boxes.

Optimize For Fast Web View Optimizes the PDF file for faster viewing in a web browser.

View PDF After Saving Opens the newly-created PDF file in the default PDF viewing application.

Create Acrobat Layers From Top-level Layers Saves Illustrator’s top-level layers as Acrobat layers within the PDF file. This allows Adobe Acrobat 6, 7, and 8 users to generate multiple versions of the document from a single file.

Note: *This option is only available when Compatibility is set to Acrobat 6 (1.5), Acrobat 7 (1.6), and Acrobat 8 (1.7).*

More Help topics

[“About Adobe PDF”](#) on page 290

[“Printing and saving transparent artwork”](#) on page 431

[“Create Adobe PDF files”](#) on page 290

Compression and downsampling options for PDF

When saving artwork in Adobe PDF, you can compress text and line art, and compress and downsample bitmap images. Depending on the settings you choose, compression and downsampling can significantly reduce the size of a PDF file with little or no loss of detail and precision.

The Compression area of the Save Adobe PDF dialog box is divided into three sections. Each section provides the following options for compressing and resampling color, grayscale, or monochrome images in your artwork.

Important: *The Preserve Illustrator Editing Capabilities option (in the General preferences area) counteracts aggressive compression and downsampling. If file size is a concern, deselect this option.*

Downsampling If you plan to use the PDF file on the web, use downsampling to allow for higher compression. If you plan to print the PDF file at high resolution, do not use downsampling. Deselect the option to disable all downsampling options.

Downsampling refers to decreasing the number of pixels in an image. To downsample color, grayscale, or monochrome images, choose an *interpolation method*—average downsampling, bicubic downsampling, or subsampling—and enter the desired resolution (in pixels per inch). Then enter a resolution in the For Images Above text box. All images with resolution above this threshold will be downsampled.

The interpolation method you choose determines how pixels are deleted:

- **Average Downsampling** Averages the pixels in a sample area and replaces the entire area with the average pixel color at the specified resolution.
- **Subsampling** Chooses a pixel in the center of the sample area and replaces the entire area with that pixel color. Subsampling significantly reduces the conversion time compared with downsampling but results in images that are less smooth and continuous.
- **Bicubic Downsampling** Uses a weighted average to determine pixel color, which usually yields better results than the simple averaging method of downsampling. Bicubic is the slowest but most precise method, resulting in the smoothest gradations.

Compression Determines the type of compression that is used. The Automatic option automatically sets the best possible compression and quality for the artwork contained in the file. For most files, this option produces satisfactory results. Use Automatic (JPEG) if you need the greatest compatibility. Use Automatic (JPEG2000) for superior compression.

- **ZIP compression** Works well on images with large areas of single colors or repeating patterns, and for black-and-white images that contain repeating patterns. ZIP compression can be lossless or lossy, depending on the Quality setting.
- **JPEG compression** Is suitable for grayscale or color images. JPEG compression is *lossy*, which means that it removes image data and may reduce image quality; however, it attempts to reduce file size with a minimal loss of information. Because JPEG compression eliminates data, it can achieve much smaller file sizes than ZIP compression.
- **JPEG2000** Is the new international standard for the compression and packaging of image data. Like JPEG compression, JPEG2000 compression is suitable for grayscale or color images. It also provides additional advantages, such as progressive display.

- **CCITT and Run Length compression** Are only available for monochrome bitmap images. CCITT (Consultative Committee on International Telegraphy and Telephony) compression is appropriate for black-and-white images and any images scanned with an image depth of 1 bit. Group 4 is a general-purpose method that produces good compression for most monochrome images. Group 3, used by most fax machines, compresses monochrome bitmaps one row at a time. Run Length compression produces the best results for images that contain large areas of solid black or white.

Image Quality Determines the amount of compression that is applied. The available options depend on the compression method. For JPEG Compression, Illustrator provides Minimum, Low, Medium, High, and Maximum Quality options. For ZIP compression, Illustrator provides 4-bit and 8-bit Quality options. If you use 4-bit ZIP compression with 4-bit images, or 8-bit ZIP compression with 4-bit or 8-bit images, the ZIP method is *lossless*; that is, data is not removed to reduce file size, so image quality is not affected. Using 4-bit ZIP compression with 8-bit data can affect the quality, however, because data is lost.

Tile Size This option is only enabled when its corresponding Compression setting is JPEG2000. It determines the size of the tiles for progressive display.

Compress Text And Line Art Applies compression to all text and line art in the file. This method results in no loss of detail or quality.

More Help topics

[“About Adobe PDF”](#) on page 290

Mark and bleed options for PDF

Bleed is the amount of artwork that falls outside of the printing bounding box, or outside the crop marks and trim marks. You can include bleed in your artwork as a margin of error—to ensure that the ink extends all the way to the edge of the page after the page is trimmed or to ensure that an image can be stripped into a keyline in a document.

The Marks & Bleed area of the Save Adobe PDF dialog box lets you specify the extent of the bleed and add a variety of printer’s marks to the file.

All Printer’s Marks Enables all printer’s marks (Trim Marks, Registration Marks, Color Bars, and Page Information) in the PDF file.

Printer Mark Type Lets you choose Roman printer’s marks, or Japanese marks for pages printed in Asian languages.

Trim Marks Places a mark at each corner of the trim area to indicate the PDF trim box boundaries.

Trim Mark Weight Determines the stroke weight of the trim marks.

Registration Marks Places marks outside the artboard for aligning the different separations in a color document.

Offset Determines the distance of all printer’s marks from the edge of the artboard. The trim marks are at the edge of the space determined by the offset.

Color Bars Adds a small square of color for each spot or process color. Spot colors converted to process colors are represented using process colors. Your service provider uses these marks to adjust ink density on the printing press.

Page Information Places page information outside the artboard of the page. Page information includes the filename, page number, current date and time, and color separation name.

Use Document Bleed Settings uses the document’s bleed settings instead of the bleed settings in this dialog box.

Bleed Top, Bottom, Left, Right Controls the bleeds for the artwork. When the  button is selected, these four values are proportional—editing one will update the values in the other three.

More Help topics

[“About Adobe PDF”](#) on page 290

Color management and PDF/X options for PDF

You can set the following options in the Output section of the Save Adobe PDF dialog box. Interactions between Output options change depending on whether Color Management is on or off and which PDF standard is selected.

Color Conversion Specifies how to represent color information in the Adobe PDF file. When you convert color objects to RGB or CMYK, also select a destination profile from the pop-up menu. All spot color information is preserved during color conversion; only the process color equivalents convert to the designated color space.

- **No Conversion** Preserves color data as is. This is the default when PDF/X-3 is selected.
- **Convert To Destination (Preserve Numbers)** Preserves color numbers for untagged content in the same color space as the destination profile (by assigning the destination profile, not converting to it). All other content is converted to the destination space. This option is not available if color management is turned off. Whether the profile is included or not is determined by the Profile Inclusion Policy.
- **Convert To Destination** Converts all colors to the profile selected for Destination. Whether the profile is included or not is determined by the Profile Inclusion Policy.

Note: When Convert to Destination is selected, and the Destination doesn't match the document profile, a warning icon appears beside the option.

Destination Describes the gamut of the final RGB or CMYK output device, such as your monitor or a SWOP standard. Using this profile, Illustrator converts the document's color information (defined by the source profile in the Working Spaces section of the Color Settings dialog box) to the color space of the target output device.

Profile Inclusion Policy Determines whether a color profile is included in the file.

Output Intent Profile Name Specifies the characterized printing condition for the document. An output intent profile is required for creating PDF/X-compliant files. This menu is only available if a PDF/X standard (or preset) is selected in the Save Adobe PDF dialog box. The available options depend on whether color management is on or off. For example, if color management is off, the menu lists available printer profiles. If color management is on, the menu lists the same profile selected for Destination Profile (provided it is a CMYK output device), in addition to other predefined printer profiles.

Output Condition Name Describes the intended printing condition. This entry can be useful for the intended receiver of the PDF document.

Output Condition Identifier A pointer to more information on the intended printing condition. The identifier is automatically entered for printing conditions that are included in the ICC registry.

Registry Name Indicates the web address for more information on the registry. The URL is automatically entered for ICC registry names.

Mark as Trapped Indicates the state of trapping in the document. PDF/X compliance requires a value of True (selected) or False (deselected). Any document that doesn't meet the requirement will fail PDF/X compliance checking.

More Help topics

[“About Adobe PDF”](#) on page 290

Font and flattening options for PDF

You can set the following options in the Advanced section of the Save Adobe PDF dialog box:

Subset Embedded Fonts When Percent Of Characters Used Is Less Than Specifies when to embed the entire font (as opposed to just the characters used in the document) based on how many of the font's characters are used in the document. For instance, if a font contains 1,000 characters but the document only uses 10 of those characters, you may decide that embedding the font is not worth the extra file size.

Overprints Specifies how to save overlapping colors that are set to overprint. You can choose to preserve the overprinting or discard the overprinting. If Compatibility (at the top of the dialog box) is set to Acrobat 4 (PDF 1.3), you can also choose to simulate overprinting by flattening the artwork.

Preset If Compatibility (at the top of the dialog box) is set to Acrobat 4 (PDF 1.3) and the artwork contains transparency, you can specify a preset (or set of options) for flattening transparency. Alternately, click Custom to customize the flattener settings.

Note: Acrobat 5 (PDF 1.4), Acrobat 6 (PDF 1.5), and Acrobat 7 (PDF 1.6) automatically preserve transparency in artwork. As a result, the Preset and Custom options are not available for these levels of compatibility.

More Help topics

[“About Adobe PDF”](#) on page 290

[“Printing and saving transparent artwork”](#) on page 431

[“About overprinting”](#) on page 438

Adding security to PDF files

When saving as PDF, you can add password protection and security restrictions, limiting not only who can open the file, but also who can copy or extract contents, print the document, and more.

A PDF file can require passwords to open a document (document open password) and to change security settings (permissions password). If you set any security restrictions in your file, you should set both passwords; otherwise, anyone who opens the file could remove the restrictions. If a file is opened with a permissions password, the security restrictions are temporarily disabled.

The RC4 method of security from RSA Corporation is used to password-protect PDF files. Depending on the Compatibility setting (in the General category), the encryption level will be high or low.

Note: Adobe PDF presets don't support passwords and security settings. If you select passwords and security settings in the Export Adobe PDF dialog box, and then click Save Preset, the passwords and security settings won't be preserved.

Security options

You can set the following options when you create a PDF or when you apply password protection to a PDF. Options vary depending on the Compatibility setting. Security options are not available for PDF/X standards or presets.

Compatibility Sets the type of encryption for opening a password-protected document. Acrobat 6 and later lets you enable metadata for searching.

Be aware that anyone using an earlier version of Acrobat cannot open a PDF document with a higher compatibility setting. For example, if you select the Acrobat 8 option, the document cannot be opened in Acrobat 6.0 or earlier.

Require Password To Open The Document Select this option to require users to type the password you specify to open the document.

Document Open Password Specify the password that users must type to open the PDF file.

Note: If you forget a password, there is no way to recover it from the document. It's a good idea to store passwords in a separate secure location in case you forget them.

Use A Password To Restrict Editing Security And Permissions Settings Restricts access to the PDF file's security settings. If the file is opened in Adobe Acrobat, the user can view the file but must enter the specified Permissions password in order to change the file's Security and Permissions settings. If the file is opened in Illustrator, Photoshop, or InDesign, the user must enter the Permissions password, since it is not possible to open the file in a view-only mode.

Permissions Password Specify a password that is required to change the permissions settings. This option is available only if the previous option is selected.

Printing Allowed Specifies the level of printing that users are allowed for the PDF document.

- **None** Prevents users from printing the document.
- **Low Resolution (150 dpi)** Lets users print at no higher than 150-dpi resolution. Printing may be slower because each page is printed as a bitmap image. This option is available only if the Compatibility option is set to Acrobat 5 (PDF 1.4) or later.
- **High Resolution** Lets users print at any resolution, directing high-quality vector output to PostScript and other printers that support advanced high-quality printing features.

Changes Allowed Defines which editing actions are allowed in the PDF document.

- **None** Prevents users from making any changes to the document that are listed in the Changes Allowed menu, such as filling in form fields and adding comments.
- **Inserting, Deleting, And Rotating Pages** Lets users insert, delete, and rotate pages, and create bookmarks and thumbnails. This option is only available for high (128-bit RC4 or AES) encryption.
- **Filling In Form Fields, And Signing** Lets users fill in forms and add digital signatures. This option doesn't allow them to add comments or create form fields. This option is only available for high (128-bit RC4 or AES) encryption.
- **Commenting, Filling In Form Fields, And Signing** Lets users add comments and digital signatures, and fill in forms. This option doesn't allow users to move page objects or create form fields.
- **Any Except Extracting Of Pages** Lets users edit the document, create and fill in form fields, and add comments and digital signatures.

Enable Copying of Text, Images, And Other Content Lets users to select and copy the contents of a PDF.

Enable Text Access For Screen Reader Devices For The Visually Impaired Lets visually impaired users read the document with screen readers, but doesn't allow users to copy or extract the document's contents. This option is available only for high (128-bit RC4 or AES) encryption.

Enable Plaintext Metadata Allows users to copy and extract content from the PDF. This option is only available when Compatibility is set to Acrobat 6 or later. Selecting this option allows storage/search systems and search engines to access metadata stored in the document.

File information and metadata

Metadata is a set of standardized information about a file, such as author name, resolution, color space, copyright, and keywords applied to it.

File information found in the Document Info panel provides general file information and object characteristics, as well as the number and names of graphic styles, custom colors, gradients, fonts, and placed art.

About metadata

Metadata is a set of standardized information about a file, such as author name, resolution, color space, copyright, and keywords applied to it. For example, most digital cameras attach some basic information to an image file, such as height, width, file format, and time the image was taken. You can use metadata to streamline your workflow and organize your files.

About the XMP standard

Metadata information is stored using the Extensible Metadata Platform (XMP) standard, on which Adobe Bridge, Adobe Illustrator, Adobe InDesign, and Adobe Photoshop are built. Adjustments made to images with Photoshop® Camera Raw are stored as XMP metadata. XMP is built on XML, and in most cases the metadata is stored in the file. If it isn't possible to store the information in the file, metadata is stored in a separate file called a *sidecar file*. XMP facilitates the exchange of metadata between Adobe applications and across publishing workflows. For example, you can save metadata from one file as a template, and then import the metadata into other files.

Metadata that is stored in other formats, such as Exif, IPTC (IIM), GPS, and TIFF, is synchronized and described with XMP so that it can be more easily viewed and managed. Other applications and features (for example, Adobe Drive) also use XMP to communicate and store information such as version comments, which you can search using Adobe Bridge.

In most cases, the metadata remains with the file even when the file format changes (for example, from PSD to JPG). Metadata also remains when files are placed in an Adobe document or project.

 *If you're a C++ or Java developer, use the XMP Toolkit SDK to customize the processing and exchange of metadata. If you're an Adobe Flash or Flex developer, use the XMP File Info SDK to customize the File Info dialog box. For more information, visit the Adobe website.*

Working with metadata in Adobe Bridge and Adobe Creative Suite components

Many of the powerful Adobe Bridge features that allow you to organize, search, and keep track of your files and versions depend on XMP metadata in your files. Adobe Bridge provides two ways of working with metadata: through the Metadata panel and through the File Info dialog box.

In some cases, multiple views exist for the same metadata property. For example, a property may be labeled Author in one view and Creator in another, but both refer to the same underlying property. Even if you customize these views for specific workflows, they remain standardized through XMP.

Document Info panel overview

You use the Document Info panel to see listings of general file information and object characteristics, as well as the number and names of graphic styles, custom colors, patterns, gradients, fonts, and placed art. To display the panel, choose Window > Document Info.

- To view a different type of information, select an option from the panel menu: Document, Objects, Graphic Styles, Brushes, Spot Color Objects, Pattern Objects, Gradient Objects, Fonts, Linked Images, Embedded Images, and Font Details.
- To view information on only the selected object, choose Selection Only from the panel menu. Leaving this option deselected lists information about the entire document.

- To save a copy of the file information as a text file, choose Save from the panel menu. Specify a name and location, and then click Save.
- To view artboard dimensions, click the Artboard tool, choose Document from the panel menu, and then click to select the artboard you want to view.

More Help topics

[“Workspace overview”](#) on page 5

Chapter 9: Type

About type

Among the most powerful aspects of Adobe Illustrator are its type features. You can add a single line of type to your artwork, create columns and rows of text, flow text into a shape or along a path, and work with letterforms as graphic objects. The fonts you choose and the settings you select in Illustrator for leading, kerning, and spacing before and after paragraphs are examples of decisions you can make about the appearance of the text in your artwork.

You can create type by using one of three methods: *Point type* begins where you click and expands in a horizontal or vertical line as you enter characters. *Area type* (also called *paragraph type*) uses the boundaries of an object to control the flow of characters. *Type on a path* flows along the edge of an open or closed path.

Importing text

You can import text into your artwork from a file that was created in another application. Illustrator supports the following formats for importing text:

- Microsoft® Word for Windows 97, 98, 2000, 2002, 2003, and 2007
- Microsoft Word for Mac OS X, 2004, and 2008
- RTF (Rich Text Format)
- Plain text (ASCII) with ANSI, Unicode, Shift JIS, GB2312, Chinese Big 5, Cyrillic, GB18030, Greek, Turkish, Baltic, and Central European encoding

One advantage of importing text from a file, rather than copying and pasting it, is that imported text retains its character and paragraph formatting. For example, text from an RTF file retains its font and style specifications in Illustrator. You can also set encoding and formatting options when importing text from a plain text file.

Important: *When importing text from Microsoft Word and RTF files, make sure that the fonts used in the file are available on your system. Missing fonts and font styles—including fonts that have the same name but different formats (Type 1, TrueType, or CID)—may cause unexpected results. On Japanese systems, differences in character sets may prevent text that was entered in Windows from appearing on-screen in Mac OS.*

Import text into a new file

- 1 Choose File > Open.
- 2 Select the text file you want to open, and click Open.

Import text into an existing file

- 1 Choose File > Place. Select the text file you want to import, and click Place.
- 2 If you are placing a plain text (.txt) file, do the following, and then click OK:
 - Specify the character set and platform that were used to create the file.
 - Select an Extra Carriage Returns option to determine how Illustrator processes extra carriage returns in the file.

- Select the Extra Spaces option if you want Illustrator to replace strings of spaces in the file with tabs. Enter the number of spaces to be replaced by a tab.

Creating text

Enter text at a point

Point type is a horizontal or vertical line of text that begins where you click and expands as you enter characters. Each line of text is independent—the line expands or shrinks as you edit it, but doesn't wrap to the next line. Entering text this way is useful for adding a few words to your artwork.

- 1 Select the Type tool **T** or the Vertical Type tool **↓T**.

The pointer changes to an I-beam within a dotted box. The small horizontal line near the bottom of the I-beam marks the position of the *baseline*, on which the text rests.

- 2 (Optional) Set text-formatting options in the Control panel, Character panel, or Paragraph panel.
- 3 Click where you want the line of text to begin.

Important: Be sure not to click an existing object, because doing so converts the type object into area type or type on a path. If an existing object is located where you want to enter text, lock or hide the object.

- 4 Enter the text. Press Enter or Return to begin a new line of text within the same type object.
- 5 When you finish entering text, click the Selection tool **⬚** to select the type object. Alternatively, Ctrl-click (Windows) or Command-click (Mac OS) the text.

Note: For more information about working with type in Illustrator, see the Working with Type white paper at www.adobe.com/go/learn_ai_type_en.

More Help topics

“Creating type on a path” on page 312

Enter text in an area

Area type (also called *paragraph type*) uses the boundaries of an object to control the flow of characters, either horizontally or vertically. When the text reaches a boundary, it automatically wraps to fit inside the defined area. Entering text this way is useful when you want to create one or more paragraphs, such as for a brochure.

- 1 Define the bounding area:

- Select the Type tool **T** or the Vertical Type tool **↓T**, and drag diagonally to define a rectangular bounding area.
- Draw the object you want to use as the bounding area. (It doesn't matter if the object has stroke or fill attributes, because Illustrator automatically removes them.) Then select the Type tool **T**, the Vertical Type tool **↓T**, the Area Type tool **⌂T**, or the Vertical Area Type tool **⌂↓T** and click anywhere on the object's path.

Type

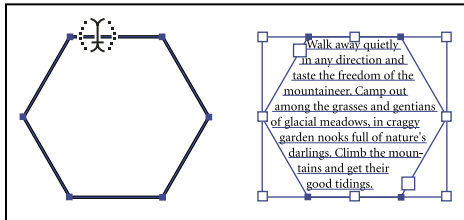
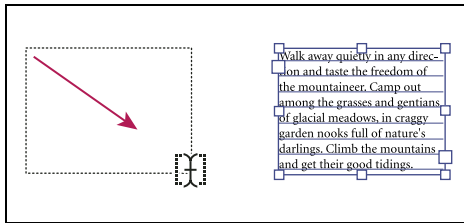

Creating a type area by dragging (top) compared to converting an existing shape to a type area (bottom)

Note: If the object is an open path, you must use the Area Type tool to define the bounding area. Illustrator draws an imaginary line between the endpoints of the path to define the boundaries.

- 2 (Optional) Set text-formatting options in the Control panel, Character panel, or Paragraph panel.
- 3 Enter the text. Press Enter or Return to begin a new paragraph.
- 4 When you finish entering text, click the Selection tool  to select the type object. Alternatively, Ctrl-click (Windows) or Command-click (Mac OS) the text.

If you enter more text than can fit within an area, a small box containing a plus symbol (+) appears near the bottom of the bounding area.

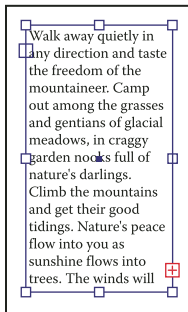

Example of overflow text

You can resize the text area or extend the path to display the overflow text. You can also thread the text into another object.

For a video on creating point and area type, see www.adobe.com/go/vid0045. For more information about working with type in Illustrator, see the Working with Type white paper at www.adobe.com/go/learn_ai_type.

More Help topics

“Creating type on a path” on page 312

Type

Resize a text area

You can resize text in different ways, depending on whether you are creating point type, area type, or text along a path.

There is no limit for the amount of text that can be written using point type, so resizing of the text box is not required in this case.

When using the area type tool, you drag an object and type inside the selected area. In this case, the text resizes when you resize the object using the Direct Selection tool.

When you type text along a path, you can thread text between objects (see “[Threading text between objects](#)” on page 309), if the text does not fit in the selected path. In this case also, the text is resized if you resize the path using the Direct Selection tool.

 *Make sure that the bounding box setting is set to Show Bounding Box. If you are not able to see the bounding box, then click View > Show Bounding Box.*

❖ To resize, do one of the following:

- Select the type object using the Selection tool or Layers panel, and drag a handle on the bounding box.

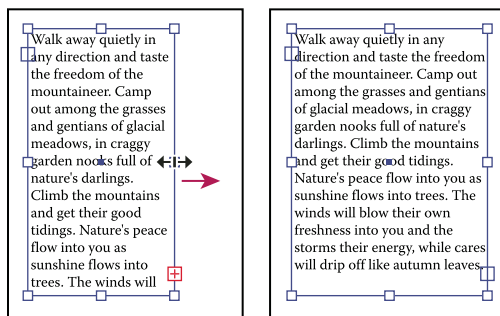

Resizing a text area with the Selection tool

- Select the edge or corner of the type path with the Direct Selection tool . Then drag to adjust the shape of the path.

 *Adjusting the type path using the Direct Selection tool is easiest when you're in Outline view.*

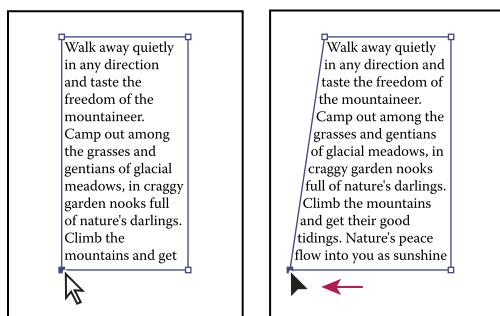

Resizing a type area with the Direct Selection tool

- Select the type object using the Selection tool or Layers panel, and choose Type > Area Type Options. Enter values for Width and Height, and click OK. If the text area is not a rectangle, these values determine the dimensions of the object's bounding box.

Type**Change the margin around a text area**

When working with an area type object, you can control the margin between the text and the bounding path. This margin is referred to as the *inset spacing*.

- 1 Select an area type object.
- 2 Choose Type > Area Type Options.
- 3 Specify a value for Inset Spacing, and click OK.

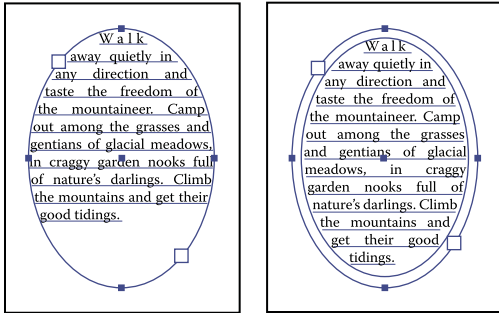

Type without inset spacing (left) compared to type with inset spacing (right)

Raise or lower the first baseline in a text area

When working with an area type object, you can control the alignment of the first line of text with the top of the object. This alignment is referred to as the *first baseline offset*. For example, you can make text stick up above the top of the object or fall a specific distance below the top of the object.

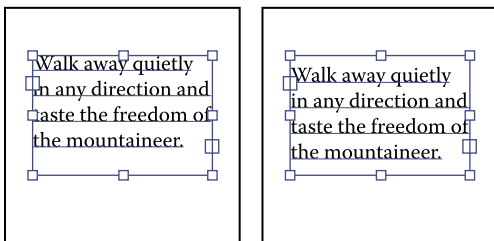

Type with First Baseline set to Cap Height (left) compared to type with First Baseline set to Leading (right)

- 1 Select an area type object.
- 2 Choose Type > Area Type Options.
- 3 For First Baseline, choose one of the following options:

Ascent The height of the “d” character falls below the top of the type object.

Cap Height The tops of uppercase letters touch the top of the type object.

Leading Uses the text’s leading value as the distance between the baseline of the first line of text and the top of the type object.

x Height The height of the “x” character falls below the top of the type object.

Em Box Height The top of the em box in Asian fonts touches the top of the type object. This option is available regardless of the Show Asian Options preference.

Fixed Specifies the distance between the baseline of the first line of text and the top of the type object in the Min box.

Legacy Uses the first baseline default used in Adobe Illustrator 10 or earlier.

Type

- 4 For Min, specify the value for the baseline offset.

More Help topics

“[Shift the baseline](#)” on page 330

“[Display Asian type options](#)” on page 348

Create rows and columns of text

- 1 Select an area type object.
- 2 Choose Type > Area Type Options.
- 3 In the Rows and Columns sections of the dialog box, set the following options:

Number Specifies the number of rows and columns you want the object to contain.

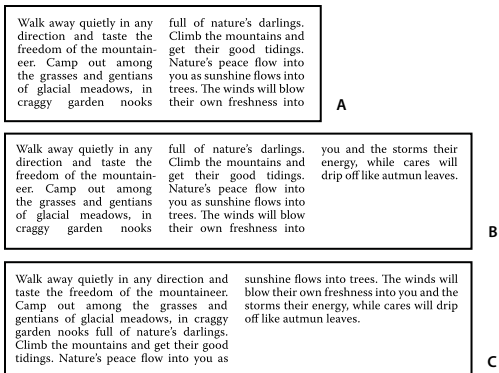

Span Specifies the height of individual rows and the width of individual columns.

Fixed Determines what happens to the span of rows and columns if you resize the type area. When this option is selected, resizing the area can change the number of rows and columns, but not their width. Leave this option deselected if you want row and column widths to change when you resize the type area.



Options for resizing rows and columns
 A. Original columns B. Columns resized with Fixed selected C. Columns resized with Fixed deselected

Gutter Specifies the distance between rows or columns.

- 4 In the Options section of the dialog box, select a Text Flow option to determine how text flows between rows and columns: By Rows  or By Columns .
- 5 Click OK.

Fit a headline across the full width of a type area

- 1 Select a type tool, and click in the paragraph you want to fit across the type area.
- 2 Choose Type > Fit Headline.

Note: If you change the formatting of the type, be sure to reapply the Fit Headline command.

Threading text between objects

To thread (or continue) text from one object to the next, you link the objects. Linked type objects can be of any shape; however, the text must be entered in an area or along a path (not at a point).

Type

Each area type object contains an *in port* and an *out port*, which enable you to link to other objects and create a linked copy of the type object. An empty port indicates that all the text is visible and that the object isn't linked. An arrow in a port indicates that the object is linked to another object. A red plus sign in an out port indicates that the object contains additional text. This remaining unseen text is called *overflow text*.

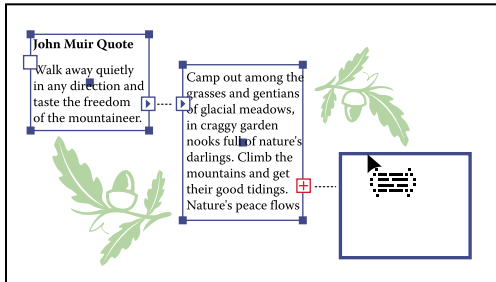

Ports on linked type objects



You can break threads and have the text flow into either the first or the next object, or you can remove all threads and have the text stay in place.

Note: When working with threaded text, it can be useful to see the threads. To view threads, choose **View > Show Text Threads** and then select a linked object.

More Help topics

[“Enter text in an area”](#) on page 305

Thread text

- 1 Use the Selection tool to select an area type object.
- 2 Click the in port or the out port of the selected type object. The pointer changes to the loaded text icon .
- 3 Do one of the following:
 - To link to an existing object, position the pointer on the object's path. The pointer changes to a . Click the path to link the objects.
 - To link to a new object, click or drag on an empty part of the artboard. Clicking creates an object of the same size and shape as the original; dragging lets you create a rectangular object of any size.

Another method for threading text between objects is to select an area type object, select the object (or objects) you want to thread to, and then choose **Type > Threaded Text > Create**.

Remove or break threads

- 1 Select a linked type object.
- 2 Do any of the following:
 - To break the thread between two objects, double-click the port on either end of the thread. The text flows into the first object.
 - To release an object from a text thread, choose **Type > Threaded Text > Release Selection**. The text flows into the next object.
 - To remove all threads, choose **Type > Threaded Text > Remove Threading**. The text stays in place.

Wrap text around an object

You can wrap area text around any object, including type objects, imported images, and objects you draw in Illustrator. If the *wrap object* is an embedded bitmap image, Illustrator wraps the text around opaque or partially opaque pixels and ignores fully transparent pixels.

Wrapping is determined by the stacking order of objects, which you can view in the Layers panel by clicking the triangle next to the layer name. To wrap text around an object, the wrap object must be in the same layer as the text and located directly above the text in the layer hierarchy. You can drag contents up or down in the Layers panel to change hierarchy.

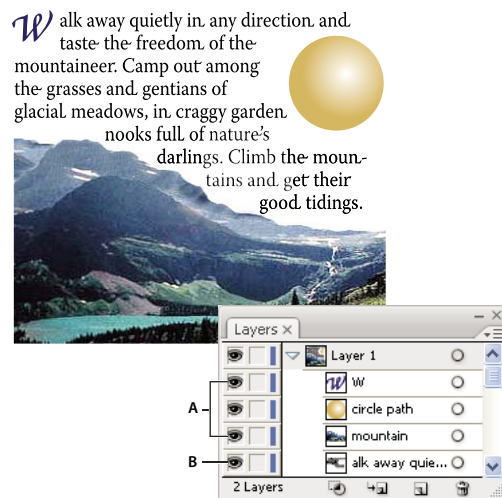

Text wrapped around objects
A. Wrap objects B. Wrapped text

More Help topics

[“Enter text in an area”](#) on page 305

[“Stacking objects”](#) on page 225

[“Creating type on a path”](#) on page 312

Wrap text

1 Make sure that the following conditions are true for the type you want to wrap:

- It is area type (typed in a box).
- It is in the same layer as the wrap object.
- It is located directly under the wrap object in the layer’s hierarchy.

Important: If the layer contains multiple type objects, move any that you don’t want to wrap around the wrap object either into another layer or above the wrap object.

2 Select the object or objects around which you want the text to wrap.

3 Choose Object > Text Wrap > Make.

Set wrap options

You can set wrap options before or after you wrap the text.

1 Select the wrap object.

Type

2 Choose Object > Text Wrap > Text Wrap Options and specify the following options:

Offset Specifies the amount of space between the text and the wrap object. You can enter a positive or negative value.

Invert Wrap Wraps the text around the reverse side of the object.

Unwrap text from an object

- 1 Select the wrap object.
- 2 Choose Object > Text Wrap > Release.

Align type to object

To align text according to the bounding box of the actual glyphs instead of the font metrics, do the following:

- 1 Apply the Outline Object live effect to the text object using Effect > Path > Outline Object.
- 2 Set the Align panel to use preview bounds by selecting the Use Preview Bounds option from the Align panel menu (flyout).

After applying these settings, you get exactly the same alignment as outlined text, while keeping the text live.

Delete empty type objects from your artwork



Deleting unused type objects makes your artwork easier to print and reduces the file size. You can create empty type objects, for example, if you inadvertently click the Type tool in the artwork area and then choose another tool.

- 1 Choose Object > Path > Clean Up.
- 2 Select Empty Text Paths, and click OK.

Creating type on a path

Type on a path flows along the edge of an open or a closed path. When you enter text horizontally, the characters are parallel to the baseline. When you enter text vertically, the characters that are perpendicular to the baseline. In either case, the text flows in the direction in which points were added to the path.

Enter text on a path

- 1 Do one of the following:
 - To create horizontal text along a path, select the Type tool **T** or the Type On A Path tool .
 - To create vertical text along a path, select the Vertical type tool **!T** or the Vertical Type On A Path tool .
- 2 (Optional) Set text-formatting options in the Control panel, Character panel, or Paragraph panel.
- 3 Position the pointer on the path, and click. (It doesn't matter if the path has stroke or fill attributes, because Illustrator automatically removes them.)

Note: If the path is closed, rather than open, you must use the Type On A Path tool.

- 4 Enter the text.
- 5 When you finish entering text, click the Selection tool  to select the type object. Alternatively, Ctrl-click (Windows) or Command-click (Mac OS) the text.

Type

If you enter more text than can fit within an area or along a path, a small box containing a plus symbol (+) appears near the bottom of the bounding area.

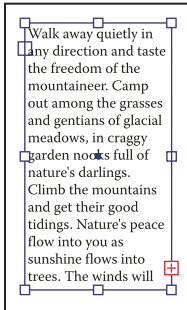

Example of overflow text

You can resize the text area or extend the path to display the overflow text. You can also thread the text into another object.

For a video on creating type on a path, see www.adobe.com/go/vid0046. For more information about working with type in Illustrator, see the Working with Type white paper at www.adobe.com/go/learn_ai_type.

Move or flip text along a path

- 1 Select the path type object.

A bracket appears at the beginning of the type, at the end of the path, and at the midpoint between the start and end brackets.

- 2 Position the pointer over the type's center bracket until a small icon appears next to the pointer

- 3 Do one of the following:

- To move text along the path, drag the center bracket along the path. Hold down Ctrl (Windows) or Command (Mac OS) to prevent the type from flipping to the other side of the path.

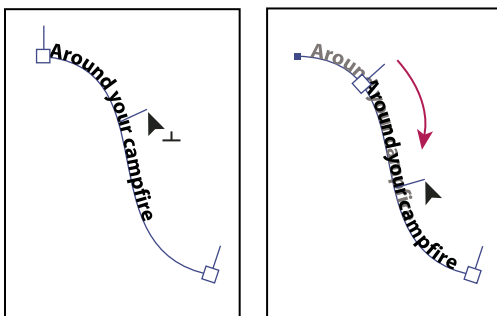

Moving type along a path

- To flip the direction of text along a path, drag the bracket across the path. Alternatively, choose Type > Type On A Path > Type On A Path Options, select Flip, and click OK.

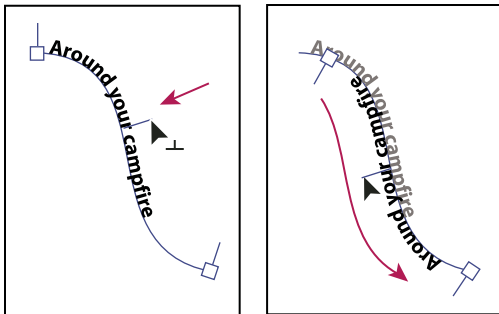

Flipping type along a path

 To move type across a path without changing the direction of the type, use the Baseline Shift option in the Character panel. For example, if you created type that runs from left to right across the top of a circle, you can enter a negative number in the Baseline Shift text box to drop the type so that it flows inside the top of the circle.

For a video on creating type on a path, see www.adobe.com/go/vid0046.

More Help topics

“[Shift the baseline](#)” on page 330

Apply effects to type on a path

Path type effects let you distort the orientation of characters on a path. You must first create type on a path before you can apply these effects.

- 1 Select the path type object.
- 2 Do one of the following:
 - Choose Type > Type On A Path and select an effect from the submenu.
 - Choose Type > Type On A Path > Type On A Path Options. Then select an option from the Effect menu, and click OK.

Note: Applying the Gravity effect to text on a perfectly circular path creates a result that looks like the default Rainbow effect. It performs as expected on paths that are oval, square, rectangular or otherwise irregularly shaped.

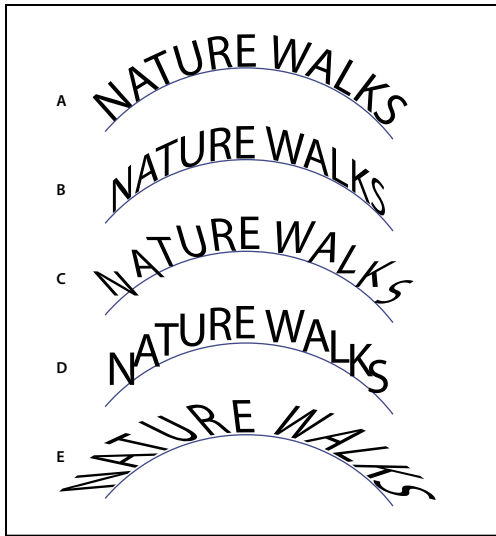
Type

Path type effects

A. Rainbow B. Skew C. 3D Ribbon D. Stair Step E. Gravity

Adjust the vertical alignment of type on a path

- 1 Select the type object.
- 2 Choose Type > Type On A Path > Type On A Path Options.
- 3 Choose an option from the Align To Path menu to specify how to align all characters to the path, relative to a font's total height:

Ascender Aligns along the font's top edge.

Descender Aligns along the font's bottom edge.

Center Aligns along the point halfway between the font's ascender and descender.

Baseline Aligns along the baseline. This is the default setting.

Note: Characters without ascenders or descenders (such as a letter e) or a baseline (such as an apostrophe) are vertically aligned with characters that have ascenders, descenders, and baselines. These font dimensions are permanently specified by the font designer.



For more control over vertical alignment, use the Baseline Shift option in the Character panel. For example, type a negative value in the Baseline Shift box to lower the type.

More Help topics

“[Shift the baseline](#)” on page 330

Adjust character spacing around sharp turns

When characters flow around a sharp curve or acute angle, they fan out in such a way that there may appear to be extra space between them. You can tighten the spacing of characters on curves using the Spacing option in the Type On A Path Options dialog box.

- 1 Select the type object.
- 2 Choose Type > Type On A Path > Type On A Path Options.

Type

- For Spacing, type a value in points. Higher values remove the extra space from between characters positioned on sharp curves or angles.

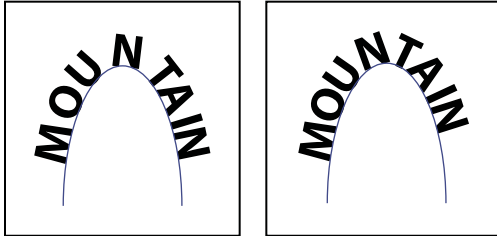

Type without spacing adjustment (left) compared to type with spacing adjustment (right)

Note: The Spacing value has no effect on characters positioned on straight segments. To change spacing of characters anywhere along the path, select them, and then apply kerning or tracking.

Scaling and rotating type

Selecting type for transformations

You can rotate, reflect, scale, and shear type just as you do other objects. However, how you select the type affects the transformation results:

- To transform the type along with its bounding path, select the type object and use the Rotate tool to rotate the object and text.
- To transform just the bounding path, but not the type it contains, select the type object and drag with the Selection tool.

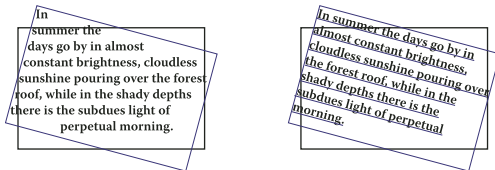

Rotated type path (left) compared to rotated type and path (right)

More Help topics

“[Transforming objects](#)” on page 230

Adjust the scale of type

You can specify the proportion between the height and width of the type, relative to the original width and height of the characters. Unscaled characters have a value of 100%. Some type families include a true *expanded font*, which is designed with a larger horizontal spread than the plain type style. Scaling distorts the type, so it is generally preferable to use a font that is designed as condensed or expanded, if one is available.

- Select the characters or type objects you want to change. If you don't select any text, the scale applies to new text you create.
- In the Character panel, set the Vertical Scaling option **I**T or the Horizontal Scaling option **T**.

Rotate type

- To rotate the characters within a type object by a specific number of degrees, select the characters or type objects you want to change. (If you don't select any text, the rotation applies to new text you create.) In the Character panel, set the Character Rotation option .
- To change horizontal type to vertical type, and vice versa, select the type object and choose Type > Type Orientation > Horizontal or Type > Type Orientation > Vertical.
- To rotate an entire type object (both the characters and the type bounding box), select the type object and use the bounding box, Free Transform tool, Rotate tool, Rotate command, or Transform panel to perform the rotation.
- To rotate multiple characters in vertical Asian text, use the *tate-chu-yoko* option to rotate multiple characters.

More Help topics

[“Character panel overview”](#) on page 323

[“Use *tate-chu-yoko*”](#) on page 350

[“Rotate objects”](#) on page 216

Spelling and language dictionaries

Check spelling

- 1 Choose Edit > Check Spelling.
- 2 To set options for finding and ignoring words, click the arrow icon at the bottom of the dialog box and set the options as desired.
- 3 Click Start to begin checking the spelling.
- 4 When Illustrator displays misspelled words or other possible errors, do one of the following:
 - Click Ignore or Ignore All to continue spell-checking without changing a certain word.
 - Select a word from the Suggestions list or type the correct word in the top box, and then click Change to change only that occurrence of the misspelled word. You can also click Change All to change all occurrences of the misspelled word in your document.
 - Click Add to have Illustrator store an acceptable but unrecognized word in the dictionary so that subsequent occurrences are not considered misspellings.
- 5 When Illustrator finishes checking your document, click Done.



Illustrator can check for spelling errors in a variety of languages, based on the language that you assign to words.

Edit the spelling dictionary

- 1 Choose Edit > Edit Custom Dictionary.
- 2 Do any of the following, and click Done:
 - To add a word to the dictionary, type the word in the Entry box, and click Add.
 - To remove a word from the dictionary, select the word in the list, and click Delete.

Type

- To modify a word in the dictionary, select the word in the list. Then type the new word in the Entry box, and click Change.

Assign languages to text

Illustrator uses Proximity language dictionaries for both spelling and hyphenation. Each dictionary contains hundreds of thousands of words with standard syllable breaks. You can assign a language to an entire document or apply a language to selected text.

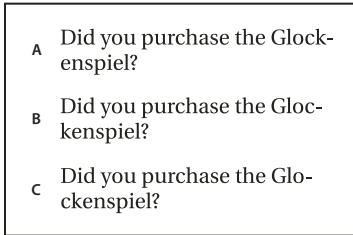

Examples of hyphenation for different languages

A. "Glockenspiel" in English B. "Glockenspiel" in Traditional German C. "Glockenspiel" in Reformed German

Apply a language to all text

- 1 Choose Edit > Preferences > Hyphenation (Windows) or Illustrator > Preferences > Hyphenation (Mac OS).
- 2 Select a dictionary from the Default Language pop-up menu, and click OK.

Assign a language to selected text

- 1 Select the text.
- 2 In the Character panel, choose the appropriate dictionary from the Language menu. If the Language menu isn't showing, choose Show Options from the Character panel menu.

About Unicode

Illustrator supports *Unicode*, a standard that assigns a unique number to every single character, no matter which language or type of computer you use. Unicode is:

Portable Letters and numbers will not change when you move the file from one workstation to another. Adding a foreign language to a document doesn't cause confusion, because foreign characters have their own designations that don't interfere with the encoding from other languages in the same project.

Platform-neutral Because Windows and Macintosh operating systems now support Unicode, moving a file between the two platforms is easier. No longer will you need to proofread an Illustrator file just because you moved to it a Windows computer from a Macintosh computer or vice versa.

Robust Because Unicode-compliant fonts offer a larger number of potential characters, specialty type characters are readily available.

Flexible With Unicode support, substituting a typeface in a project won't result in substituted characters. With a Unicode-compliant font, a *g* is a *g* no matter which typeface is used.

All of these things make it possible for a French designer to design for a client in Korea and hand the job off to a partner in the United States without having to struggle with the text. All the U.S. designer needs to do is enable the correct language in the operating system, load the foreign-language font, and continue the project.

Fonts

About fonts

A *font* is a complete set of characters—letters, numbers, and symbols—that share a common weight, width, and style, such as 10-pt Adobe Garamond Bold.

Typefaces (often called *type families* or *font families*) are collections of fonts that share an overall appearance, and are designed to be used together, such as Adobe Garamond.

A *type style* is a variant version of an individual font in a font family. Typically, the *Roman* or *Plain* (the actual name varies from family to family) member of a font family is the base font, which may include type styles such as regular, bold, semibold, italic, and bold italic.

In addition to the fonts installed on your system, you can also create the following folders and use fonts installed in them:



Windows Program Files/Common Files/Adobe/Fonts

Mac OS Library/Application Support/Adobe/Fonts

If you install a Type 1, TrueType, OpenType, or CID font into the local Fonts folder, the font appears in Adobe applications only.

OpenType fonts

OpenType fonts use a single font file for both Windows® and Macintosh® computers, so you can move files from one platform to another without worrying about font substitution and other problems that cause text to reflow. They may include a number of features, such as swashes and discretionary ligatures, that aren't available in current PostScript and TrueType fonts.

 *OpenType fonts display the  icon.*

When working with an OpenType font, you can automatically substitute alternate glyphs, such as ligatures, small capitals, fractions, and old style proportional figures, in your text.

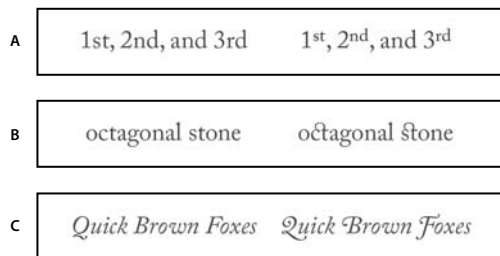





Regular (left) and OpenType (right) fonts
A. Ordinals B. Discretionary ligatures C. Swashes

OpenType fonts may include an expanded character set and layout features to provide richer linguistic support and advanced typographic control. OpenType fonts from Adobe that include support for central European (CE) languages include the word “Pro,” as part of the font name in application font menus. OpenType fonts that don’t contain central European language support are labeled “Standard,” and have an “Std” suffix. All OpenType fonts can also be installed and used alongside PostScript Type 1 and TrueType fonts.

For more information on OpenType fonts, see www.adobe.com/go/opentype.

Previewing fonts

You can view samples of a font in the font family and font style menus in the Character panel and other areas in the application from where you can choose fonts. The following icons are used to indicate different kinds of fonts:

- OpenType 
- Type 1 
- TrueType 
- Multiple Master 
- Composite 

You can turn off the preview feature or change the point size of the font names or font samples in Type preferences.

Select a font family and style

- 1 Select the characters or type objects you want to change. If you don't select any text, the font applies to new text you create.
- 2 Select a font family and style using the Control panel, Type menu, or Character panel:
 - In the Control panel, set the Font and Font Style options.
 - In the Type menu, select a name from the Font or Recent Fonts submenu. Using the Font menu is convenient because it displays a preview of the available fonts.
 - In the Character panel, set the Font Family and Font Style options. In addition to choosing a name from the pop-up menus, you can click the current name and type in the first few characters of the name you want.

 *To change the number of fonts in the Recent Fonts submenu, choose Edit > Preferences > Type (Windows) or Illustrator > Preferences > Type (Mac OS), and set the Number Of Recent Fonts option.*

Specify a typeface size

By default, typeface size is measured in *points* (a point equals 1/72 of an inch). You can specify any typeface size from 0.1 to 1296 points, in 0.001-point increments.

Note: *In Fireworks, the typeface size is measured in pixels by default.*

- 1 Select the characters or type objects you want to change. If you don't select any text, the typeface size applies to new text you create.
- 2 Do one of the following:
 - In the Character panel or Control bar set the Font Size option.
 - Choose a size from the Type > Size menu. Choosing Other lets you type a new size in the Character panel.

 *You can change the unit of measurement for type in the Preferences dialog box. This option is not available in Fireworks.*

Find and replace fonts

- 1 Choose Type > Find Font.

 *Move the Find Font dialog box so that you can see all the text in your document.*

Type

- 2 Select the name of a font you want to find in the top section of the dialog box. The first occurrence of the font is highlighted in the document window.
- 3 Select a replacement font in the bottom section of the dialog box. You can customize the list of replacement fonts by doing the following:
 - Choose an option from the Replace With Font From pop-up menu: Document to list only the fonts that are used in the document or System to list all fonts on your computer.
 - Select the kinds of fonts you want to include in the list; deselect the kinds of fonts you don't want to include.
- 4 Do one of the following:
 - Click Change to change just one occurrence of the selected font.
 - Click Change All to change all occurrences of the selected font.

When there are no more occurrences of a font in your document, its name is removed from the Fonts in Document list.

- 5 Repeat steps 2 through 4 to find and replace a different font.
- 6 Click Done to close the dialog box.

Note: When you replace a font using the Find Font command, all other type attributes remain the same.

Work with missing fonts

If a document uses fonts not installed on your system, an alert message appears when you open it. Illustrator indicates which fonts are missing and substitutes missing fonts with available matching fonts.

- To substitute missing fonts with a different font, select the text that uses the missing font and apply any other available font.
- To make missing fonts available in Illustrator, either install the missing fonts on your system or activate the missing fonts using a font management application.
- To highlight substituted fonts in pink, choose File > Document Setup, and select Highlight Substituted Fonts (and Highlighted Substituted Glyphs, if desired), and then click OK.

Formatting type

Selecting type

Selecting characters lets you edit them, format them using the Character panel, apply fill and stroke attributes to them, and change their transparency. You can apply these changes to one character, a range of characters, or all characters in a type object. When characters are selected, they are highlighted in the document window and the word “Characters” appears in the Appearance panel.

Selecting a type object lets you apply global formatting options to all the characters in the object, including options from the Character and Paragraph panels, fill and stroke attributes, and transparency settings. In addition, you can apply effects, multiple fills and strokes, and opacity masks to a selected type object. (This is not possible for individually selected characters.) When a type object is selected, a bounding box appears around it in the document window and the word “Type” appears in the Appearance panel.

Selecting a type path lets you adjust its shape and apply fill and stroke attributes to it. This level of selection is not available for point type. When a type path is selected, the word “Path” appears in the Appearance panel.

More Help topics

[“Keys for working with type”](#) on page 481



[“Selection tool gallery”](#) on page 18

Select characters

- ❖ Select any type tool, and do one of the following:
 - Drag to select one or more characters. Shift-drag to extend or reduce the selection.
 - Position the pointer in a word, and double-click to select that word.
 - Position the pointer in a paragraph, and triple-click to select the entire paragraph.
 - Select one or more characters, and choose **Select > All** to select all the characters in the type object.

Select type objects



Selecting a type object lets you apply global formatting options to all the characters in the object, including options from the Character and Paragraph panels, fill and stroke attributes, and transparency settings. In addition, you can apply effects, multiple fills and strokes, and opacity masks to a selected type object. (This is not possible for individually selected characters.) When a type object is selected, a bounding box appears around it in the document window and the word “Type” appears in the Appearance panel.

- ❖ Do any of the following:
 - In the document window, click the type with the Selection tool  or the Direct Selection tool . Shift-click to select additional type objects.
 - In the Layers panel, locate the type object you want to select and then click its right edge, between the target button and the scroll bar. Shift-click at the right edge of items in the Layers panel to add or remove objects to the existing selection.
 - To select all type objects in a document, choose **Select > Object > Text Objects**.

Select a type path

Selecting a type path lets you adjust its shape and apply fill and stroke attributes to it. This level of selection is not available for point type. When a type path is selected, the word “Path” appears in the Appearance panel.

 *Selecting a type path is easiest when you’re in Outline view.*

- 1 Select the Direct Selection tool  or the Group Selection tool .
- 2 If the type object is selected, click outside the object’s bounding box to deselect it.
- 3 Click the type path, being careful not to click the characters. (If you do click a character, you will select the type object instead of the type path.)

Note: *The Type Object Selection By Path Only preference determines the sensitivity of the selection tools when selecting type objects in the document window. When this preference is selected, you must click directly on the type path to select the type. When this preference is deselected, you can click the type or the path to select the type. You can set this preference by choosing **Edit > Preferences > Type (Windows)** or **Illustrator > Preferences > Type (Mac OS)**.*

Find and replace text

- 1 Choose **Edit > Find and Replace**.
- 2 Enter the text string you want to find and, if desired, the text string with which to replace it.

Type

You can choose a variety of special characters from the pop-up menus to the right of the Find and Replace With options.

3 To customize how Illustrator searches for the specified text string, select any of the following options:

Match Case Searches only for text strings that exactly match the uppercase and lowercase text in the Find box.

Find Whole Word Searches only for entire words that match the text in the Find box.

Search Backwards Searches the file from the bottom to the top of the stacking order.

Check Hidden Layers Searches for text in hidden layers. When this option is deselected, Illustrator ignores text in hidden layers.

Check Locked Layers Searches for text in locked layers. When this option is deselected, Illustrator ignores text in locked layers.

4 Click Find to begin the search.

5 If Illustrator finds an instance of the text string, do one of the following:

- Click Replace to replace the text string, then click Find Next to find the next instance.
- Click Replace & Find to replace the text string and find the next instance.
- Click Replace All to replace all instances of the text string in the document.

6 Click Done to close the dialog box.



To find the next instance of a text string when the Find And Replace dialog box is closed, choose Edit > Find Next.

Change the color and appearance of characters

You can change the color and appearance of type objects by applying fills, strokes, transparency settings, effects, and graphic styles. The text remains editable as long as you don't rasterize it.

1 Do one of the following:

- To change the appearance of specific characters in a type object, select the characters.
- To change the appearance of all characters in a type object, or to apply multiple fills and strokes, select the type object.
- To fill or stroke a type path, select the type path.

2 Apply fills, strokes, transparency settings, effects, and graphic styles as desired.

When you change the color of a type object, Illustrator overwrites the attributes of individual characters in the type object.



Use the Control panel to quickly change the color of selected type.

More Help topics

[“About appearance attributes”](#) on page 362

Character panel overview

You use the Character panel (Window > Type > Character) to apply options for formatting individual characters in your documents. When type is selected or when the Type tool is active, you can also use options in the Control panel to format characters.

Type

For a video on working with character and paragraph styles, see www.adobe.com/go/vid0047.

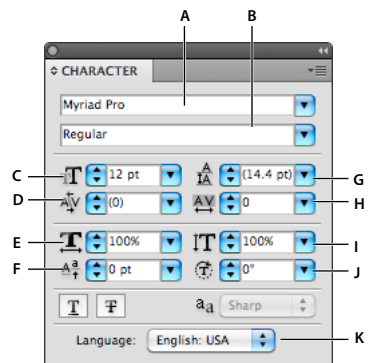

Character panel

A. Font B. Font Style C. Font Size D. Kerning E. Horizontal Scale F. Baseline Shift G. Leading H. Tracking I. Vertical Scale J. Character Rotation K. Language



A. Font B. Font Style C. Font Size D. Align left E. Align center F. Align right

By default, only the most commonly used options are visible in the Character panel. To show all options, choose Show Options from the options menu. Alternatively, click the double triangle on the panel's tab to cycle through the display sizes.

More Help topics

“[Keys for working with type](#)” on page 481

“[Workspace overview](#)” on page 5

Underline or strike through text

- 1 Select the type you want to underline or strike through. If you don't select any text, the setting applies to new text you create.
- 2 Do one of the following:
 - To underline type, click the Underline button **T** in the Character panel.
 - To strike through type, click the Strikethrough button **F** in the Character panel.

The default weight of an underline and strikethrough depends on the size of the type.

Apply all caps and small caps

When you format text as small caps, Illustrator automatically uses the small-cap characters designed as part of the font, if available. Otherwise, Illustrator *synthesizes* the small caps using scaled-down versions of the regular capital letters.

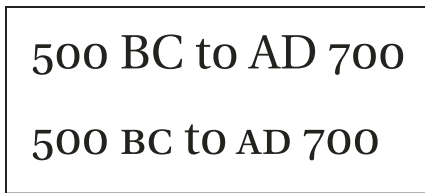
Type

Regular capital letters (top) compared to small-cap letters (bottom)

- 1 Select the characters or type objects you want to change. If you don't select any text, the setting applies to new text you create.
- 2 Choose All Caps or Small Caps from the Character panel menu.

To specify the size for synthesized small caps, choose File > Document Setup. For Small Caps, type a percentage of the original font size for text to be formatted as small caps. (The default value is 70%.)



To change the capitalization style of text to uppercase, lowercase, title case, or sentence case, use the Type > Change Case command.

More Help topics

[“Character panel overview”](#) on page 323

Change capitalization styles

- 1 Select the characters or type objects you want to change.
- 2 Choose one of the following in the Type > Change Case submenu:

UPPERCASE to change all characters to uppercase.

Note: The UPPERCASE command causes discretionary ligatures to revert to normal text. This also occurs with the Title Case and Sentence Case commands when a discretionary ligature appears at the beginning of a word.

lowercase to change all characters to lowercase.

Title Case to capitalize the first letter of each word.

Sentence Case to capitalize the first letter of each sentence.

Note: The Sentence Case command assumes that the period (.), exclamation point (!), and question mark (?) characters mark the ends of sentences. Applying Sentence Case may cause unexpected case changes when these characters are used in other ways, as in abbreviations, filenames, or URLs. In addition, proper names may become lowercase.



If you're using an OpenType font, you may want to take advantage of All Caps formatting to create more elegant type.

More Help topics

[“Apply all caps and small caps”](#) on page 324

Specify curly or straight quotes

Typographer's quotes, often referred to as curly quotes, blend in with the curves of the font. Typographer's quotes are traditionally used for quotation marks and apostrophes. *Straight quotes* are traditionally used as abbreviations for feet and inches.

- ❖ Choose File > Document Setup, and do one of the following; then click OK:
 - To use straight quotes, deselect Use Typographer's Quotes.
 - To use typographer's quotes, select Use Typographer's Quotes, choose the language for which you want to set quotes, and choose options for Double Quotes and Single Quotes.

Note: You can set quote options for multiple languages. These quotes are applied to text based on the language you assign using the Character panel or Default Language preference.



You can use the Smart Punctuation command to replace straight quotes with typographer's quotes.

More Help topics

[“Assign languages to text”](#) on page 318

[“Use smart punctuation”](#) on page 329

Set anti-aliasing options for type

When you save artwork in a bitmap format—such as JPEG, GIF, or PNG—Illustrator rasterizes all objects at 72 pixels per inch and applies anti-aliasing to them. However, if your artwork contains type, the default anti-aliasing settings may not produce the desired results. Illustrator provides several options specifically for rasterizing type. To take advantage of these options, you must rasterize type objects before you save the artwork.

- 1 Select the type object, and do one of the following:
 - To permanently rasterize the type, choose Object > Rasterize.
 - To create the appearance of rasterization without changing the object's underlying structure, choose Effect > Rasterize.
- 2 Choose an anti-aliasing option:

None Applies no anti-aliasing and maintains the hard edges of type when it is rasterized.

Art Optimized (Supersampling) Default option that rasterizes all objects, including text objects by the specified resolution and applies anti-aliasing to them. Default resolution is 300 pixels per inch.

Type Optimized (Hinted) Applies anti-aliasing that is best suited to type. Anti-aliasing reduces the appearance of jagged edges in the rasterized image and gives type a smoother on-screen appearance. However, it can also make small text difficult to read.

Creating superscripts or subscripts

Superscript and *subscript* text (also called *superior* and *inferior* text) is reduced-size text that is raised or lowered in relation to a font's baseline.

When you create superscript or subscript type, Illustrator applies a predefined baseline shift value and typeface size. The values applied are percentages of the current font size and leading, and are based on settings in the Type section of the Document Setup dialog box.

More Help topics

[“OpenType fonts”](#) on page 319

[“OpenType panel overview”](#) on page 333

Create superscripts or subscripts in regular fonts

- 1 Select the type you want to change. If you don't select any type, any new text you create will be rendered as superscripts or subscripts.
- 2 Choose Superscript or Subscript from the Character panel menu. You can access the Character panel from the Control panel.

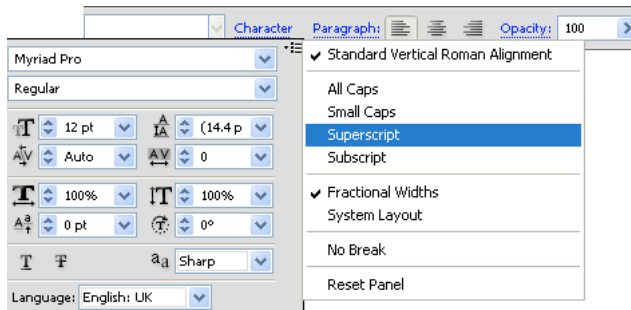

Superscript and Subscript options in the Character panel menu

Create superscripts or subscripts in OpenType fonts

- 1 Select the characters you want to change to superscript or subscript. If you don't select any text, the setting applies to new text you create.
- 2 Make sure that an OpenType font is selected. One way to determine if a font is an OpenType font is to look in the Type > Font menu; OpenType fonts display the  icon.
- 3 In the OpenType panel, choose an option from the Position pop-up menu:

Default Position Uses the default position for the current font.

Superscript/Superior Uses raised characters (if available in the current font).

Subscript/Inferior Uses lowered characters (if available in the current font).

Numerator Uses characters designed as fraction numerators (if available in the current font).

Denominator Uses characters designed as fraction denominators (if available in the current font).

Change the size and position of superscripts or subscripts

- ❖ Choose File > Document Setup, specify the following values for Superscript and Subscript, and then click OK:
 - For Size, type a percentage of the font size for superscripted and subscripted text.
 - For Position, type a percentage of the regular leading to specify how much the superscript and subscript text will move.

Convert type to outlines

You can turn type into a set of compound paths, or outlines, that you can edit and manipulate as you would any other graphic object. Type as outlines are useful for changing the look of large display type, but they are rarely useful for body text or other type at small sizes.

Type

Font outline information comes from the actual font files installed on your system. When you create outlines from type, characters are converted in their current positions; they retain all graphics formatting such as their stroke and fill.



Modifying a letterform

A. Original type object **B.** Type converted to outlines, ungrouped, and modified

Note: You can't convert bitmap fonts or outline-protected fonts to outlines.

When you convert type to outlines, the type loses its *hints*—instructions built into fonts to adjust their shape so that your system displays or prints them optimally at a wide range of sizes. If you plan to scale the type, adjust its point size before converting.

You must convert all the type in a selection; you cannot convert a single letter within a string of type. To convert a single letter into an outline, create a separate type object containing only that letter.

- 1 Select the type object.
- 2 Choose Type > Create Outlines.

Choose a number style in OpenType fonts

- 1 To change the style of existing numbers, select the characters or type objects you want to change. If you don't select any text, the setting applies to new text you create.
- 2 Make sure that an OpenType font is selected.
- 3 In the OpenType panel, choose an option from the Figures pop-up menu:

Default Figure Uses the default style for the current font.

Tabular Lining Uses full-height figures all of the same width (if available for the current font). This option is appropriate in situations where numbers need to line up from one line to the next, as in tables.

Proportional Lining Uses full-height figures with varying widths (if available for the current font). This option is recommended for text that uses all caps.

Proportional Oldstyle Uses varying-height figures with varying widths (if available for the current font). This option is recommended for a classic, sophisticated look in text that doesn't use all caps.

Tabular Oldstyle Uses varying-height figures with fixed, equal widths (if available for the current font). This option is recommended when you want the classic appearance of old-style figures, but need them to align in columns, as in an annual report.

More Help topics

[“OpenType fonts”](#) on page 319

[“OpenType panel overview”](#) on page 333

Format fractions and ordinals in OpenType fonts

When using an OpenType font, you can automatically format ordinal numbers with superscript characters (for example, 2nd). Characters such as the superscript “a” and “o” in the Spanish words *segunda* (2^a) and *segundo* (2^o) are also typeset properly. You can also convert numbers separated by a slash (such as 1/2) to a shilling fraction (such as ½).

- 1 Select the characters or type objects to which you want to apply the setting. If you don’t select any text, the setting applies to new text you create.
- 2 Make sure that an OpenType font is selected.
- 3 In the OpenType panel, click the Ordinals button to enable or disable ordinals or the Fractions button to enable or disable fractions. These buttons have an effect only if ordinals and fractions are available in the font.

More Help topics

[“OpenType fonts”](#) on page 319

[“OpenType panel overview”](#) on page 333

Use smart punctuation

The Smart Punctuation command searches for keyboard punctuation characters and replaces them with their typographic equivalents. In addition, you can use the Smart Punctuation command to globally insert ligatures and fractions, if the font includes these characters.

 *If you’re using an OpenType font, use the OpenType panel instead of the Smart Punctuation dialog box to typeset ligatures and fractions.*

- 1 If you want to replace characters in specific text, rather than all text in the document, select the desired text objects or characters.
- 2 Choose Type > Smart Punctuation.
- 3 Select one or more of the following options:

ff, fi, ffi Ligatures Renders ff, fi, or ffi letter combinations as ligatures.

ff, fl, ffl Ligatures Renders ff, fl, or ffl letter combinations as ligatures.

Smart Quotes Changes straight keyboard quotation marks into curly quotes.

Note: The Smart Quotes option always replaces straight quotes with curly quotes, regardless of the Double Quotes and Single Quotes settings in the Document Setup dialog box.

Smart Spaces Eliminates multiple spaces after a period.

En, Em Dashes Replaces a double keyboard dash with an en dash and a triple keyboard dash with an em dash.

Ellipses Replaces three keyboard periods with ellipsis points.

Expert Fractions Replaces separate characters used to represent fractions with their single-character equivalents.

- 4 Select Entire Document to replace text symbols in the entire file or Text Only to replace symbols only in selected text.
- 5 (Optional) Select Report Results to see a list of the number of symbols replaced.

- 6 Click OK to search for and replace selected characters.

More Help topics

“[Use ligatures and contextual alternates](#)” on page 334

Line and character spacing



Set the leading

The vertical space between lines of type is called *leading* (rhymes with *sledding*). Leading is measured from the baseline of one line of text to the baseline of the line above it. *Baseline* is the invisible line on which most letters sit.

The default auto-leading option sets the leading at 120% of the typeface size (for example, 12-point leading for 10-point type). When auto-leading is in use, the leading value appears in parentheses in the Leading menu of the Character panel. You can change this default auto-leading by choosing Justification from the Paragraph panel menu and specifying a percentage from 0 to 500.

By default, leading is a character attribute, which means that you can apply more than one leading value within the same paragraph. The largest leading value in a line of type determines the leading for that line.

Note: When working with horizontal Asian type, you can specify how leading is measured, either from baseline to baseline or from the top of one line to the top of the next.

- 1 Select the characters or type objects you want to change. If you don't select any text, the leading applies to new text you create.
- 2 In the Character panel, set the Leading option  ( for vertical text).

Shift the baseline

Use Baseline Shift to move selected characters up or down relative to the baseline of the surrounding text. Shifting the baseline is especially useful when you're hand-setting fractions or adjusting the position of a picture font.

- 1 Select the characters or type objects you want to change. If you don't select any text, the shift applies to new text you create.
- 2 In the Character panel, set the Baseline Shift option. Positive values move the character's baseline above the baseline of the rest of the line; negative values move it below the baseline.

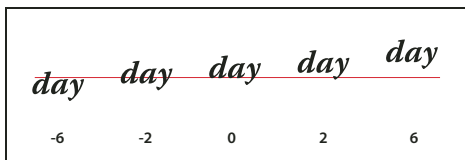

Type with different Baseline Shift values

Kern and track

Kerning is the process of adding or subtracting space between specific pairs of characters. *Tracking* is the process of loosening or tightening the spacing between the characters in selected text or an entire block of text.

Type

You can automatically kern type using metrics kerning or optical kerning. *Metrics kerning* (also called *Auto kerning*) uses kern pairs, which are included with most fonts. Kern pairs contain information about the spacing of specific pairs of letters. Some of these are: LA, P., To, Try, Ta, Tu, Te, Ty, Wa, WA, We, Wo, Ya, and Yo. Metrics kerning is set as the default so that specific pairs are automatically kerned when you import or type text.

Some fonts include robust kern-pair specifications. However, when a font includes only minimal built-in kerning or none at all, or if you use two different typefaces or sizes in one or more words on a line, you may want to use the *optical kerning* option. Optical kerning adjusts the spacing between adjacent characters based on their shapes.

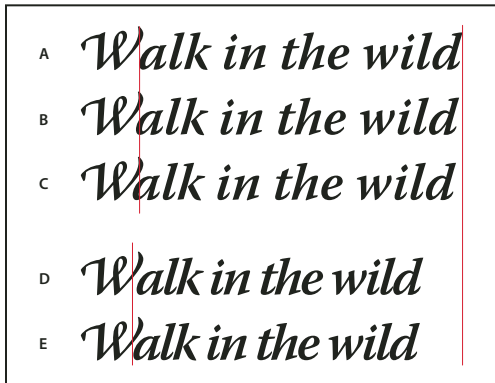

Kerning and tracking options

A. Original text B. Text with optical kerning C. Text with manual kerning between W and a D. Text with tracking E. Cumulative kerning and tracking

You can also use *manual kerning*, which is ideal for adjusting the space between two letters. Tracking and manual kerning are cumulative, so you can first adjust individual pairs of letters, and then tighten or loosen a block of text without affecting the relative kerning of the letter pairs.

When you click to place the insertion point between two letters, kerning values appear in the Character panel. Metrics and optical kerning values (or defined kern pairs) appear in parentheses. Similarly, if you select a word or a range of text, the tracking values appear in the Character panel.

Tracking and kerning are both measured in 1/1000 em, a unit of measure that is relative to the current typeface size. In a 6-point font, 1 em equals 6 points; in a 10-point font, 1 em equals 10 points. Kerning and tracking are strictly proportional to the current typeface size.

Note: Values for kerning and tracking affect Japanese text, but normally these options are used to adjust the *aki* between roman characters.

Adjust kerning

❖ Do any of the following:

- To use a font's built-in kerning information for selected characters, select Auto or Metrics for the Kerning option in the Character panel.
- To automatically adjust the spacing between selected characters based on their shapes, select Optical for the Kerning option in the Character panel.
- To adjust kerning manually, place an insertion point between two characters, and set the desired value for the Kerning option in the Character panel. (Note that if a range of text is selected, you can't manually kern the text. Instead, use tracking.)



Press **Alt+Left/Right Arrow** (Windows) or **Option+Left/Right Arrow** (Mac OS) to decrease or increase the kerning between two characters.

- To turn off kerning for selected characters, set the Kerning option in the Character panel to 0 (zero).

Adjust tracking

- 1 Select the range of characters or the type object that you want to adjust.
- 2 In the Character panel, set the Tracking option.

Turn fractional character widths off or on

By default, the software uses *fractional character widths* between characters. This means that the spacing between characters varies, and will sometimes use only fractions of whole pixels.

In most situations, fractional character widths provide the best spacing for type appearance and readability. However, for type in small sizes (less than 20 points) displayed online, fractional character widths could cause type to run together or have too much extra space, making it difficult to read.

Turn off fractional widths when you want to fix type spacing in whole-pixel increments and prevent small type from running together. The fractional character width setting applies to all characters on a type layer—you cannot set the option for selected characters.

❖ Do any of the following:

- To set type spacing for the entire document in whole-pixel increments, choose System Layout from the Character panel menu.
- To re-enable fractional character widths, choose Fractional Widths from the Character panel menu.

Special characters

About character sets and alternate glyphs

Typefaces include many characters in addition to the ones you see on your keyboard. Depending on the font, these characters can include ligatures, fractions, swashes, ornaments, ordinals, titling and stylistic alternates, superior and inferior characters, old-style figures, and lining figures. A *glyph* is a specific form of a character. For example, in certain fonts, the capital letter A is available in several forms, such as swash and small cap.

There are two ways to insert alternate glyphs:

- The *Glyphs panel* lets you view and insert glyphs from any typeface.
- The *OpenType panel* lets you set up rules for using glyphs. For example, you can specify that you want to use ligatures, titling characters, and fractions in a given text block. Using the OpenType panel is easier than inserting glyphs one at a time and ensures a more consistent result. However, the panel works only with OpenType fonts.

Glyphs panel overview

You use the Glyphs panel (Window > Type > Glyphs) to view the glyphs in a font and insert specific glyphs in your document.

By default, the Glyphs panel displays all the glyphs for the currently selected font. You can change the font by selecting a different font family and style at the bottom of the panel. If any characters are currently selected in your document, you can display alternate characters by selecting Alternates For Current Selection from the Show menu at the top of the panel.

Type

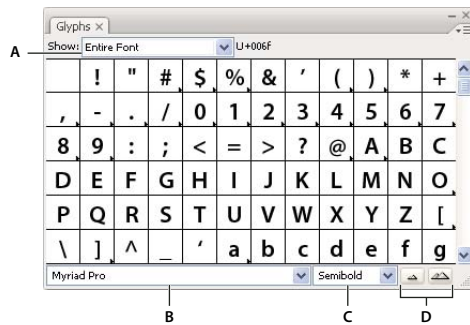

Glyphs panel
 A. Show menu B. Font family C. Font style D. Zoom buttons

When you select an OpenType font in the Glyphs panel, you can restrict the panel to display certain kinds of glyphs by selecting a category from the Show menu. You can also display a pop-up menu of alternate glyphs by clicking the triangle in the lower right corner of the glyph box where applicable.

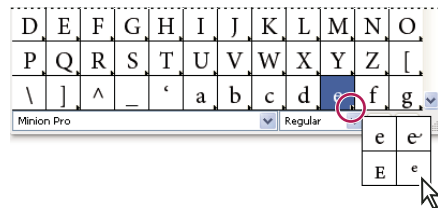

Pop-up menu for alternate glyphs

For a video on working with the Glyphs panel and the OpenType panel, see www.adobe.com/go/vid0048.

More Help topics

“[Workspace overview](#)” on page 5

Insert or replace a character using the Glyphs panel

- 1 To insert a character, click with a type tool to place the insertion point where you want to enter the character, and then double-click the character you want to insert in the Glyphs panel.
- 2 To replace a character, choose Alternates For Current Selection from the Show pop-up menu, select a character in your document using a type tool. Double-click a glyph in the Glyphs panel, if one is available.

Note: Additional replacement options are available for Asian glyphs.

OpenType panel overview

You use the OpenType panel (Window > Type > OpenType) to specify how you want to apply alternate characters in OpenType fonts. For example, you can specify that you want to use standard ligatures in new or existing text.

Keep in mind that OpenType fonts vary greatly in the kinds of features they offer; not all options in the OpenType panel are available in every font. You can view the characters in a font using the Glyphs panel.

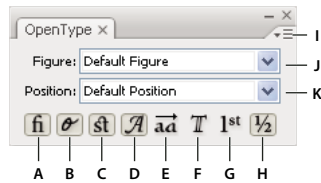
Type*OpenType panel*

A. Standard Ligatures B. Contextual Alternates C. Discretionary Ligatures D. Swash E. Stylistic Alternates F. Titling Alternates G. Ordinals H. Fractions I. panel menu J. Figure type K. Character position

Note: Additional features may be available for Asian OpenType fonts.

You can access additional commands and options in the OpenType panel menu in the upper right corner of the panel. For a video on working with the Glyphs panel and the Open Type panel, see www.adobe.com/go/vid0048.

More Help topics

[“Set Asian OpenType font attributes”](#) on page 348

[“Workspace overview”](#) on page 5

Highlight alternate glyphs in the text

- 1 Choose File > Document Setup.
- 2 Select Highlight Substituted Glyphs, and click OK. Substituted glyphs in the text are highlighted.

Use ligatures and contextual alternates

Ligatures are typographic replacement characters for certain letter pairs. Most fonts include ligatures for standard letter pairs such as fi, fl, ff, ffi, and ffl. In addition, some fonts include discretionary ligatures for letter pairs such as ct, st, and ft. Although the characters in ligatures appear to be joined, they are fully editable and do not cause the spell checker to flag a word erroneously.

Contextual alternates are alternate characters included in some script typefaces to provide better joining behavior. For example, when using Caflisch Script Pro with contextual alternates enabled, the letter pair “bl” in the word “bloom” is joined so that it looks more like handwriting.

- 1 Select the characters or type objects to which you want to apply the setting. If you don’t select any text, the setting applies to new text you create.
- 2 Make sure that an OpenType font is selected.
- 3 In the OpenType panel, do any of the following:
 - Click the Standard Ligatures button to enable or disable ligatures for standard letter pairs (such as fi, fl, ff, ffi, and ffl).
 - Click the Discretionary Ligatures button to enable or disable optional ligatures (if available in the current font).
 - Click the Contextual Alternates button to enable or disable contextual alternates (if available in the current font).

More Help topics

[“OpenType fonts”](#) on page 319

[“OpenType panel overview”](#) on page 333

Use swashes, titling alternates, or stylistic alternates

Many OpenType fonts include stylized characters that let you add decorative elements to type. Swashes are characters with exaggerated flourishes. Titling alternates are characters (usually all in capitals) designed for use in large-size settings, such as titles. Stylistic alternates are stylized characters that create a purely esthetic effect.

- 1 Select the characters or type objects to which you want to apply the setting. If you don't select any text, the setting applies to new text you create.
- 2 Make sure that an OpenType font is selected.
- 3 In the OpenType panel, do one of the following:
 - Click the Swash button to enable or disable swash characters (if available in the current font).
 - Click the Stylistic Alternates button to enable or disable stylistic alternates (if available in the current font).
 - Click the Titling Alternates button to enable or disable titling alternates (if available in the current font).

More Help topics

[“OpenType fonts”](#) on page 319

[“OpenType panel overview”](#) on page 333

Show or hide nonprinting characters

Nonprinting characters include hard returns (line breaks), soft returns (line breaks), tabs, spaces, nonbreaking spaces, double-byte characters (including spaces), discretionary hyphens, and the end-of-text character.

To make the characters visible as you format and edit type, choose Type > Show Hidden Characters. A check mark indicates that nonprinting characters are visible.

Formatting paragraphs

Paragraph panel overview

You use the Paragraph panel (Window > Type > Paragraph) to change the formatting of columns and paragraphs. When type is selected or when the Type tool is active, you can also use options in the Control panel to format paragraphs.

For a video on working with character and paragraph styles, see www.adobe.com/go/vid0047.

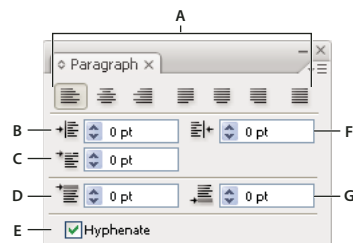

Paragraph panel (all options shown)

A. Alignment and Justification B. Left Indent C. First Line Left Indent D. Space Before Paragraph E. Hyphenation F. Right Indent G. Space After Paragraph

Type

A. Font B. Font Style C. Font Size D. Align left E. Align center F. Align right

By default, only the most commonly-used options in the Paragraph panel are visible. To show all options, choose Show Options from the panel menu. Alternatively, click the double triangle on the panel's tab to cycle through the display sizes.

More Help topics

[“Workspace overview”](#) on page 5

[“Keys for working with type”](#) on page 481

Align text

Area type and type on a path can be aligned with one or both edges of a type path.

- 1 Select the type object or insert the cursor in the paragraph you want to change.

If you don't select a type object or insert the cursor in a paragraph, the alignment applies to new text you create.

- 2 In the Control panel or Paragraph panel, click an alignment button.

Justify text

Text is justified when it is aligned with both edges. You can justify all text in a paragraph either including or excluding the last line.

- 1 Select the type object or insert the cursor in the paragraph you want to justify.

If you don't select a type object or insert the cursor in a paragraph, the justification applies to new text you create.

- 2 In the Paragraph panel, click a justification button.

Adjust word and letterspacing in justified text

You can precisely control how Adobe applications space letters and words and scale characters. Adjusting spacing is especially useful with justified type, although you can also adjust spacing for unjustified type.

- 1 Insert the cursor in the paragraph you want to change, or select a type object or frame to change all of its paragraphs.
- 2 Choose Justification from the Paragraph panel menu.
- 3 Enter values for Word Spacing, Letter Spacing, and Glyph Spacing. The Minimum and Maximum values define a range of acceptable spacing for justified paragraphs only. The Desired value defines the desired spacing for both justified and unjustified paragraphs:

Word Spacing The space between words that results from pressing the spacebar. Word Spacing values can range from 0% to 1000%; at 100%, no additional space is added between words.

Letter Spacing The distance between letters, including kerning or tracking values. Letter Spacing values can range from -100% to 500%; at 0%, no space is added between letters; at 100%, an entire space width is added between letters.

Glyph Scaling The width of characters (a *glyph* is any font character). Glyph Spacing values can range from 50% to 200%.



Spacing options are always applied to an entire paragraph. To adjust the spacing in a few characters, but not an entire paragraph, use the Tracking option.

- 4 Set the Single Word Justification option to specify how you want to justify single-word paragraphs.

In narrow columns, a single word can occasionally appear by itself on a line. If the paragraph is set to full justification, a single word on a line may appear to be too stretched out. Instead of leaving such words fully justified, you can center them or align them to the left or right margins.

Indent text

Indentation is the amount of space between text and the boundary of a type object. Indentation affects only the selected paragraph or paragraphs, so you can easily set different indentions for different paragraphs.

You can set indents using the Tabs panel, the Control panel, or the Paragraph panel. When working with area type, you can also control indentation using tabs or by changing the inset spacing for the type object.



 *When working with Japanese type, you can use the *mojikumi* setting instead of the Paragraph panel to specify the indent for the first line. If you specify the indent for the first line in the Paragraph panel, and specify *mojikumi* settings for the first line indent, the text is placed inside the total of both indents.*

More Help topics



[“Paragraph panel overview”](#) on page 335

[“Change the margin around a text area”](#) on page 308

Set indents using the Paragraph panel

- 1 Using the Type tool , click in the paragraph you want to indent.
- 2 Adjust the appropriate indent values in the Paragraph panel. For example, do the following:
 - To indent the entire paragraph one pica, type a value (such as **1p**) in the Left Indent box .
 - To indent only the first line of a paragraph one pica, type a value (such as **1p**) in the First Line Left Indent box .
 - To create a hanging indent of one pica, type a positive value (such as **1p**) in the Left Indent box and type a negative value (such as **-1p**) in the First Line Left Indent box.

Set an indent using the Tabs panel

- 1 Using the Type tool , click in the paragraph you want to indent.
- 2 Do one of the following to the indent markers  in the Tabs panel:
 - Drag the top marker to indent the first line of text. Drag the bottom marker to indent all but the first line. Ctrl-drag (Windows) or Command-drag (Mac OS) the bottom marker to move both markers and indent the entire paragraph.

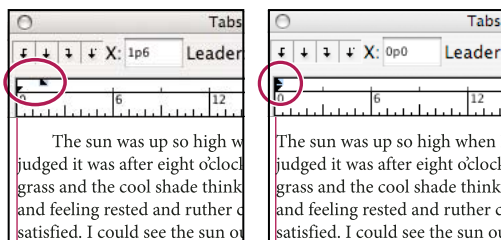

First-line indent (left) and no indent (right)

- Select the top marker and type a value for X to indent the first line of text. Select the bottom marker and type a value for X to move all but the first sentence.

Create a hanging indent

In a hanging indent, all the lines in a paragraph are indented except for the first line. Hanging indents are especially useful when you want to add inline graphics at the beginning of the paragraph, or when you want to create a bulleted list.

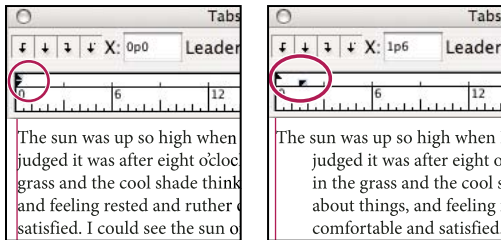

No indent (left) and hanging indent (right)

- 1 Using the Type tool **T**, click in the paragraph you want to indent.
- 2 In the Control panel or the Tabs panel, specify a left indent value greater than zero.
- 3 To specify a negative first-line left indent value, do one of the following:
 - In the Paragraph panel, type a negative value for the first-line left indent ¶¶.
 - In the Tabs panel, drag the top marker to the left, or the bottom marker to the right.

Adjust paragraph spacing

- 1 Insert the cursor in the paragraph you want to change, or select a type object to change all of its paragraphs. If you don't insert the cursor in a paragraph or select a type object, the setting applies to new text you create.
- 2 In the Paragraph panel, adjust the values for Space Before (¶¶ or ¶¶) and Space After (¶¶ or ¶¶).

Note: If a paragraph begins at the top of a column, no extra space is added before the paragraph. In this case, you can increase the leading of the first line of the paragraph or change the inset spacing for the type object.

More Help topics

[“Paragraph panel overview”](#) on page 335

[“Set the leading”](#) on page 330

Hanging punctuation

Hanging punctuation makes the edges of text appear more even by moving punctuation marks outside the paragraph margins.



Paragraph without hanging punctuation (left) compared to paragraph with hanging punctuation (right)

Illustrator provides the following options for hanging punctuation:

Roman Hanging Punctuation Controls the alignment of punctuation marks for a specific paragraph. When Roman Hanging Punctuation is turned on, the following characters appear 100% outside the margins: single quotes, double quotes, hyphens, periods, and commas; the following characters appear 50% outside the margins: asterisks, tildes, ellipses, en dashes, em dashes, colons, semicolons. To apply this setting, insert the cursor in the paragraph and select Roman Hanging Punctuation from the Paragraph panel menu.

Optical Margin Alignment Controls the alignment of punctuation marks for all paragraphs within a type object. When Optical Margin Alignment is turned on, roman punctuation marks as well as the edges of letters (such as W and A) hang outside the text margins so that the type looks aligned. To apply this setting, select the type object and choose Type > Optical Margin Alignment.

Burasagari Controls the alignment of double-byte punctuation marks (available in Chinese, Japanese, and Korean fonts). These punctuation marks are not affected by the Roman Hanging Punctuation option or Optical Margin Alignment option.

Keep in mind that the paragraph alignment determines the margin from which the punctuation hangs. For left-aligned and right-aligned paragraphs, punctuation hangs off the left and right margin, respectively. For top-aligned and bottom-aligned paragraphs, punctuation hangs off the top and bottom margin, respectively. For centered and justified paragraphs, punctuation hangs off both margins.

Note: When a punctuation character is followed by a quotation mark, both characters hang.

More Help topics

[“Paragraph panel overview”](#) on page 335

[“Specify a burasagari option”](#) on page 356

Hyphenation and line breaks

You can specify how words and lines break by adjusting hyphenation settings automatically, or by using the hyphenation dictionary.

Illustrator uses the same composition methods for line and word breaks that is used in Adobe InDesign. For more information on using these features, see web Help.

Adjust hyphenation automatically

The settings you choose for hyphenation affect the horizontal spacing of lines and the aesthetic appeal of type on a page. Hyphenation options determine whether words can be hyphenated and, if so, what breaks are allowable.

1 To use automatic hyphenation, do any of the following:

- To turn automatic hyphenation on or off, select or deselect the Hyphenate option in the Paragraph panel.
- To apply hyphenation to specific paragraphs, first select only the paragraphs that you want to affect.
- To choose a hyphenation dictionary, choose a language from the Language menu at the bottom of the Character panel.

2 To specify options, choose Hyphenation from the Paragraph panel menu, and specify the following options:

Words Longer Than _ Letters Specifies the minimum number of characters for hyphenated words.

Type

After First _ Letters And Before Last _ Letters Specifies the minimum number of characters at the beginning or end of a word that can be broken by a hyphen. For example, by specifying 3 for these values, **aromatic** would be hyphenated as **aro- matic** instead of **ar- omatic** or **aromat- ic**.

Hyphen Limit Specifies the maximum number of consecutive lines on which hyphenation may occur. Zero means unlimited consecutive hyphens are allowed at ends of lines.

Hyphenation Zone Specifies a distance from the right edge of a paragraph, demarcating a portion of the line where hyphenation is not allowed. A setting of 0 allows all hyphenation. This option applies only when you use the Adobe Single-line Composer.

Hyphenate Capitalized Words Select to prevent capitalize words from being hyphenated.

Note: Hyphenation settings apply only to Roman characters; double-byte characters available in Chinese, Japanese, and Korean fonts are not affected by these settings.

Use the hyphenation dictionary

Illustrator uses Proximity language dictionaries to determine when to hyphenate words. These dictionaries let you specify a different language for as little as a single character of text. You can select a default dictionary and customize the dictionary in the Preferences dialog box.

- 1 Choose Edit > Preferences > Hyphenation (Windows) or Illustrator > Preferences > Hyphenation (Mac OS).
- 2 Do any of the following:
 - To choose a default hyphenation dictionary, select an option for Default Language, and click OK.
 - To add a word to the exceptions list, type the word in the New Entry box, and click Add.
 - To remove a word from the exceptions list, select the word, and click Delete.

Prevent words from breaking

You can prevent words from breaking at the end of lines—for example, proper names or words that could be misread when hyphenated. You can also keep multiple words or groups of words together—for example, clusters of initials and a last name.

- 1 Select the characters you want to prevent from breaking.
- 2 Choose No Break from the Character panel menu.

Note: If you apply the No Break option to too many adjacent characters, the text may wrap in the middle of a word. However, if you apply the No Break option to more than a single line of text, none of the text will appear.

Composition methods

The appearance of type on the page depends on a complex interaction of processes called *composition*. Using the word spacing, letterspacing, glyph spacing, and hyphenation options you've selected, Adobe applications evaluate possible line breaks and choose the one that best supports the specified parameters.

You can choose between two composition methods: the Adobe Every-line Composer and the Adobe Single-line Composer. Both methods evaluate possible breaks and choose the one that best supports the hyphenation and justification options you've specified for a given paragraph. The composition method affects only the selected paragraph or paragraphs, so you can easily set different composition methods for different paragraphs.

Type**Every-line Composer**

The Every-line Composer considers a network of break points for a range of lines and thus can optimize earlier lines in the paragraph in order to eliminate especially unattractive breaks later on.

The Every-line Composer approaches composition by identifying possible break points, evaluating them, and assigning a weighted penalty based on the following principles:

- For left-, right-, or center-aligned text, lines that fall closer to the right side are favored and have a lower penalty.
- For justified text, the highest importance is given to evenness of letter and word spacing.
- Hyphenation is avoided when possible.

Single-line Composer

The Single-line composer offers a traditional approach to composing type one line at a time. This option is useful if you want manual control over how lines break. The Single-line Composer uses the following principles when considering a breakpoint:

- Longer lines are favored over shorter lines.
- In justified text, compressed or expanded word spacing is preferable to hyphenation.
- In nonjustified text, hyphenation is preferable to compressed or expanded letterspacing.
- If spacing must be adjusted, compression is better than expansion.

To choose one of these methods, select it from the Paragraph panel menu. To apply the method to all paragraphs, first select the type object; to apply the method to the current paragraph only, first insert the cursor in that paragraph.

Tabs

You use the Tabs panel (Window > Type > Tabs) to set tab stops for a paragraph or type object. For more information on using and setting tabs, see web Help.

Tabs panel overview

You use the Tabs panel (Window > Type > Tabs) to set tab stops for a paragraph or type object.

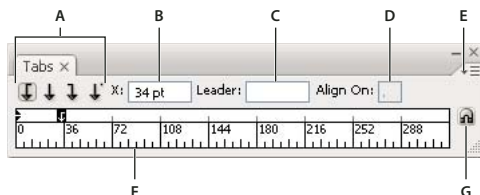

Tabs panel

A. Tab alignment buttons B. Tab position C. Tab leader box D. Align On box E. Panel menu F. Tab ruler G. Snap panel above frame

You can access additional commands and options in the Tabs panel menu. To use this menu, click the triangle in the upper right corner of the panel.

More Help topics

[“Workspace overview”](#) on page 5

[“Change the unit of measurement”](#) on page 43

Align the Tabs panel with a selected type object

You can position the Tabs panel anywhere in the work area; however, it is usually helpful to align the Tabs panel with a type object.

- ❖ Click the magnet icon . The Tabs panel moves directly above the selected text object, with the zero point aligned with the left margin. If necessary, you can drag the resize button at the lower right corner of the panel to expand or reduce the ruler.

Snap tab stops to the ruler units

By default, you can position tab stops anywhere along the tab ruler.

- ❖ Choose Snap To Unit from the panel menu or hold down Shift as you drag a tab stop.

Change the units of measure for the tab ruler

The units of measure for the tab ruler are defined by the General units settings specified in the Units preferences (for all files) or by the units specified in the Document Setup dialog box (for the current file).

- To change the units of measure for all files, specify a new value for General Units in the Units preferences.
- To change the units of measure for the current file, specify a new units value in the Document Setup dialog box.

Set tabs

Tab stops apply to an entire paragraph. When you set the first tab, Illustrator deletes all default tab stops to the left of that stop. As you set more tab stops, Illustrator deletes all default tabs between the tabs you set.

- 1 Insert the cursor in a paragraph, or select a type object to set tab stops for all paragraphs in the object.
- 2 In the Tabs panel, click a tab-alignment button to specify how text aligns relative to the tab's position:

Left-Justified Tab to align horizontal text to the left, keeping the right margin ragged.

Center-Justified Tab to center text on the tab mark.

Right-Justified Tab to align horizontal text to the right, keeping the left margin ragged.

Bottom-Justified Tab to align vertical text to the bottom margin, keeping the top margin ragged.

Top-Justified Tab to align vertical text to the top margin, keeping the bottom margin ragged.

Decimal-Justified Tab to place text in alignment with a specified character, such as a period or a dollar sign. This option is useful for creating columns of numbers.

You can change the alignment of any tab by simply selecting it and clicking one of these buttons.

- 3 Do one of the following:

- Click a location on the tab ruler to position a new tab stop.
- Type a position in the X box (for horizontal text) or Y box (for vertical text), and press Enter or Return. If the X or Y value is selected, press the Up Arrow or Down Arrow key to increase or decrease the tab value by 1 point, respectively.

Type

Note: When you use the tab ruler, you cannot set tab stops in increments smaller than 1. However, if you specify a position in the X or Y box, you can set stops at intervals as small as 0.01 point.

4 Repeat steps 2 and 3 to add additional tab stops.

Note: For information on setting indents using the Tabs panel, see “[Indent text](#)” on page 337.

Repeat tabs

The Repeat Tab command creates multiple tabs based on the distance between the tab and the left indent or the previous tab stop.

- 1 Click an insertion point in the paragraph.
- 2 In the Tabs panel, select a tab stop on the ruler.
- 3 Choose Repeat Tab from the panel menu.

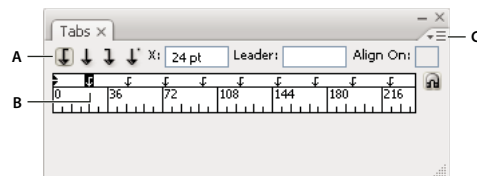

Repeated tabs

A. Tab-alignment buttons B. Tab stop on the ruler C. Panel menu

Move tabs

- 1 In the Tabs panel, select a tab stop on the ruler.
- 2 Do one of the following:
 - Type a new location in the X box (for horizontal text) or Y box (for vertical text), and press Enter or Return.
 - Drag the tab to a new location.
 - To move all tab stops simultaneously, Ctrl-drag (Windows) or Command-drag (Mac OS) a tab.

As you move a tab stop, a visual guide appears in the selected text.

Remove tabs

- ❖ Do one of the following:
 - Drag the tab off the tab ruler.
 - Select the tab, and choose Delete Tab from the panel menu.
 - To return to the default tab stops, choose Clear All from the panel menu.

Specify characters for decimal tabs

You use decimal tabs to align text with a character you specify, such as a period or a dollar sign.

- 1 In the Tabs panel, create or select a decimal tab ↓ on the tab ruler.
- 2 In the Align On box, type the character to which you want to align. You can type or paste any character. Make sure that the paragraphs you're aligning contain that character.

Type

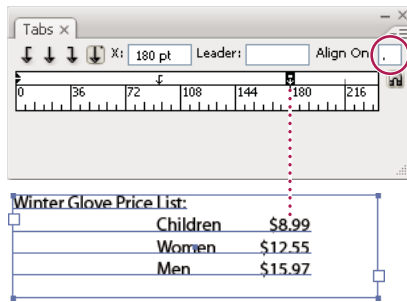

Text aligned using a decimal tab

Add tab leaders

A *tab leader* is a repeated pattern of characters, such as a series of dots or dashes, between a tab and the following text.

- 1 In the Tabs panel, select a tab stop on the ruler.
- 2 Type a pattern of as many as eight characters in the Leader box, and then press Enter or Return. The characters you entered repeat across the width of the tab.
- 3 To change the font or other formatting of the tab leader, select the tab character in the text frame, and use the Character panel or Type menu to apply formatting.

Character and paragraph styles

About character and paragraph styles

A *character style* is a collection of character-formatting attributes that you can apply to a selected range of text. A *paragraph style* includes both character- and paragraph-formatting attributes, and can be applied to a selected paragraph or range of paragraphs. Using character and paragraph styles saves time and ensures consistent formatting.

You use the Character Styles and Paragraph Styles panels to create, apply, and manage character and paragraph styles. To apply a style, simply select text and click a style name in one of the panels. If you don't select any text, the style applies to new text you create.

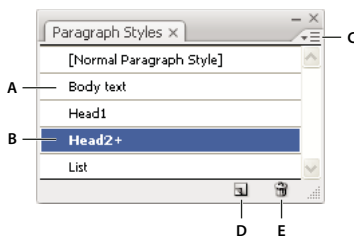

Paragraph Styles panel

A. Style name B. Style with additional formatting (overrides) C. Panel menu D. New Style button E. Delete icon

When you select text or insert the cursor in text, the active styles are highlighted in the Character Styles and Paragraph Styles panels. By default, every character in a document is assigned the Normal Character Style and every paragraph is assigned the Normal Paragraph Style. These default styles are the building blocks for all other styles you create.

A plus sign next to a style name indicates that there are *overrides* to the style. An override is any formatting that doesn't match the attributes defined by the style. Any time you change settings in the Character and OpenType panel, you create an override to the current character style; likewise, when you change settings in the Paragraph panel, you create an override to the current paragraph style.

For a video about using character and paragraph styles in Illustrator, see www.adobe.com/go/vid0047.

More Help topics

[Using styles in Illustrator video](#)

Create character or paragraph styles

- 1 If you want to base the new style on the formatting of existing text, select the text.
- 2 In the Character Styles panel or the Paragraph Styles panel, do one of the following:
 - To create a style with the default name, click the Create New Style button.
 - To create a style with a custom name, choose New Style in the panel menu. Type a name, and click OK.



To create a copy of a character or paragraph style, drag the style onto the New Style button.

Edit character or paragraph styles

You can change the definition of the default character and paragraph styles, as well as any new styles you create. When you change the definition of a style, all of the text formatted with that style changes to match the new style definition.

- 1 In the Character Styles panel or the Paragraph Styles panel, do one of the following:
 - Select the style in the panel, and choose Character Style Options from the Character Styles panel menu or Paragraph Style Options from the Paragraph Styles panel menu.
 - Double-click the style name.

Note: Double-clicking applies the style to any selected text or, if no text is selected, sets the style for any new text you type. If you don't want to apply the style, hold down Shift+Ctrl (Windows) or Shift+Command (Mac OS) when you double-click the style name.

- 2 On the left side of the dialog box, select a category of formatting options and set the options you want. You can switch to a different group of formatting options by selecting a different category.

If you need more information about any of the formatting options, search for the option name in Help.

- 3 When you finish setting options, click OK.

Remove style overrides

A plus sign next to the style name in the Character Styles panel or the Paragraph Styles panel indicates that there are overrides to the style. An override is any formatting that doesn't match the attributes defined by the style. There are several ways to remove style overrides:

- To clear overrides and return text to the appearance defined by the style, reapply the same style or choose Clear Overrides from the panel menu.
- To clear overrides when applying a different style, Alt-click (Windows) or Option-click (Mac OS) the style name.
- To redefine the style and maintain the current appearance of the text, select at least one character of the text and choose the Redefine Style command from the panel menu.

If you use styles to maintain consistent formatting, you should probably avoid overrides. If you're formatting quick, one-time-only text, these overrides pose no problem.

Delete character or paragraph styles

When you delete styles, the appearance of paragraphs tagged with the style doesn't change, but their formatting is no longer associated with a style.

- 1 Select the style name or names in the Character Styles panel or the Paragraph Styles panel.
- 2 Do one of the following:
 - Choose Delete Character Style or Delete Paragraph Style from the panel menu.
 - Click the Delete icon  at the bottom of the panel.
 - Drag the style to the Delete icon at the bottom of the panel.

 *To delete all unused styles, choose Select All Unused from the panel menu, and then click the Delete icon.*

Load character and paragraph styles from another Illustrator document

- 1 In the Character Styles panel or the Paragraph Styles panel, do one of the following:
 - Choose Load Character Styles or Load Paragraph Styles from the panel menu.
 - Choose Load All Styles from the panel menu to load both character and paragraph styles.
- 2 Double-click the Illustrator document containing the styles you want to import.

Exporting text

Export text to a text file

- 1 Using a type tool, select the text you want to export.
- 2 Choose File > Export.
- 3 In the Export dialog box, select a location for the file and enter a filename.
- 4 Choose Text Format (TXT) as the file format.
- 5 Enter the name of the new text file in the name box, and click Save (Windows) or Export (Mac OS).
- 6 Choose a platform and encoding method, and click Export.

Tag text for export to Flash

You can export text from Illustrator to Adobe Flash in a variety of ways. You can export text as a static, dynamic, or input text. Dynamic text also allows you to specify a URL for the site that will open when a user clicks the text. For more information about dynamic and input text, see Flash Help.

Flash text can contain point text, area text, or text on a path; all text is converted to area text in SWF format. Bounding boxes remain the same and any transformations applied to them are preserved in SWF format. Threaded text objects are exported individually —if you want to tag and export all objects in a thread, make sure that you select and tag each one. Overflow text is imported into Flash Player intact.

Type

Once you tag text, you can import it into Flash by either exporting the text from Illustrator or copying and pasting the text.

For a video on using text effectively between Illustrator and Flash, see www.adobe.com/go/vid0199.

Note: Tagging or untagging text does not change the original text in Illustrator. You can change the tag at anytime without altering the original.

- 1 Select a text object and click Flash Text in the Control panel.
- 2 In the Flash Text panel, select one of the following from the Type menu:

Static Text Exports text to Flash Player as a regular text object that cannot be changed dynamically or programmatically in Flash. The content and appearance of static text are determined when you author the text.

Dynamic Text Exports the text as Dynamic text, which can update programmatically at run time through Action script commands and tags. You can use dynamic text for sports scores, stock quotes, news headlines, and similar purposes in which you want the text to update dynamically.

Input Text Exports the text as Input text, which is the same as Dynamic text, but also allows users to edit the text in Flash Player. You use input text for forms, surveys, or other similar purposes in which you want users to input or edit text.

- 3 (Optional) Enter an instance name for the text object. If you do not enter an instance name, the default name of the text object in the Layers panel is used in Flash to manipulate the text object.
- 4 Specify a Rendering Type. The Use Device Fonts option converts glyphs to device fonts (anti-aliasing is not available for device fonts).

Note: Font names are normally used verbatim and passed directly to the playback platform's font system to locate the font. However, there are several special indirect font names that are mapped to different font names depending on the playback platform. These indirect mappings are hard-coded into each platform-specific port of Flash Player, and the fonts for each platform are chosen from among system default fonts or other fonts that are likely to be available. As a secondary consideration, the indirect mappings are specified to maximize the similarity of indirect fonts across platforms.

Animation Optimizes text for output to animation.

Readability Optimizes text for readability.

Custom Lets you specify custom values for Thickness and Sharpness of text.

Use Device Fonts Converts glyphs to device fonts. Anti-aliasing is not available for device fonts.

_sans, _serif, and _typewriter Map western indirect fonts across platforms to ensure a similar appearance.

Gothic, Tohoba (Gothic Mono), and Mincho Map Japanese indirect fonts across platforms to ensure a similar appearance.

Note: For more information on indirect fonts, see the Flash specification document, which you can find on Adobe.com.

- 5 (Optional) Select any of the following:

Selectable  Makes the exported text selectable in Flash.

Show Border Around Text  Makes the text borders visible in Flash.

Edit Character Options  Opens the Character Embedding dialog box so that you can embed specific characters in the text object. You can choose the characters you want to embed from the provided list, type the characters in the Include These Characters text box, click Auto Fill to automatically select characters that need to be embedded, or do any combination of these.

- 6 (Optional) If you tagged the text as Dynamic text, you can specify the URL of the page you want to open when the text is clicked, and then choose a target window to specify where you want to load the page:

_self Specifies the current frame in the current window.

_blank Specifies a new window.

_parent Specifies the parent of the current frame.

_top Specifies the top-level frame in the current window.

7 If you tagged the text as Input Text, specify the Maximum Characters that can be typed into the text object.

 *Once you tag text as Flash text, you can select all such text at once by choosing Select > Object > Flash Dynamic Text or Flash Input Text.*

More Help topics

[Flash text video](#)

“[Flash export options](#)” on page 285

Formatting Asian characters

Illustrator provides a variety of options for formatting Asian characters. For example, you can set Asian Open Type font attributes, use tate-chu-yoko, aki, warichu, mojisoroe, mojikumi, kinsoku, burasagari, and kurikaeshi moji shori. In addition, you can combine Asian and roman fonts and create composite fonts.

***Note:** To enable support for GB18030 fonts for Simplified Chinese in Windows XP, see the Readme file in the Illustrator CS5\Simplified Chinese\Goodies\Optional Extensions\GB18030 folder.*

Display Asian type options

By default, Illustrator hides Asian type options in the Character panel, Paragraph panel, OpenType panel, and Type menu.

1 Choose Edit > Preferences > Type (Windows) or Illustrator > Preferences > Type (Mac OS).

2 Select Show Asian Options, and click OK.

You can also control how font names are displayed (in English or in the native language) by selecting or deselecting Show Font Names in English.

***Note:** Your operating system must support the languages in which you wish to work. Consult your system software manufacturer for more information.*

More Help topics

“[About Unicode](#)” on page 318

Set Asian OpenType font attributes

Asian OpenType fonts may include a number of features that aren't available in current PostScript and TrueType fonts. In addition, Asian OpenType fonts provide alternate glyphs for many characters.

1 Select the characters or type objects to which you want to apply the setting. If you don't select any text, the setting applies to new text you create.

2 Make sure that an OpenType font is selected.

Look in the Type > Font menu; OpenType fonts display the  icon.

3 In the OpenType panel, set any of the following options:

Proportional Metrics Kerning is according to the proportional metrics of the font.

H or V Style Switches hiragana fonts, which have different glyphs for horizontal and vertical such as contracted sounds, double consonants, and phonetic indexes.

Roman Italics Changes half-width alphanumerics to italics.

More Help topics

[“About character sets and alternate glyphs”](#) on page 332

[“OpenType fonts”](#) on page 319

[“OpenType panel overview”](#) on page 333

Replace Asian characters with a different glyph form

1 Select the characters you want to replace.

2 Choose an option from the Glyphs panel menu. If you don't see the following options, select Show Asian Options in the Type preferences. If an option is dimmed, the glyph form is not available for the current font:

Traditional Forms Replaces the selected characters with traditional forms.

Expert Forms Replaces the selected characters with their expert forms.

JIS 04 Forms Replaces the selected characters with JIS 04 forms.

JIS 90 Forms Replaces the selected characters with JIS 90 forms.

JIS 78 Forms Replaces the selected characters with JIS 78 forms.

JIS 83 Forms Replaces the selected characters with JIS 83 forms.

Monospaced Half-Width Forms Changes the glyphs of the selected Latin characters to monospace hankaku (half width).

Monospaced Third-Width Forms Changes the glyphs of the selected Latin characters to monospace third width.

Monospaced Quarter-Width Forms Changes the glyphs of the selected Latin characters to monospace quarter width.



To revert an alternate glyph to its default form, select it and choose Revert To Default Forms from the Glyphs panel menu. You cannot use this method to revert alternate glyphs that were applied using a character style.

More Help topics

[“About character sets and alternate glyphs”](#) on page 332

[“Glyphs panel overview”](#) on page 332

[“Display Asian type options”](#) on page 348

Specify how leading is measured in Asian type

1 Select the paragraphs you want to adjust.

2 Choose a leading option from the Paragraph panel menu.

Top-to-top Leading Measures the spacing between lines of type from the top of one line to the top of the next line. When you use top-to-top leading, the first line of type in a paragraph is aligned flush with the top of the bounding box.

Type

Bottom-to-bottom Leading For horizontal type, measures the space between lines of type from the type baseline. When you use bottom-to-bottom leading, space appears between the first line of type and the bounding box. A check mark indicates which option is selected.

Note: The leading option you choose does not affect the amount of leading between lines, only how the leading is measured.

Rotate half-width characters in vertical text

The direction of half-width characters, such as roman text or numbers, changes in vertical text. By default, half-width characters are rotated individually.

If you don't want half-width characters to rotate, deselect Standard Vertical Roman Alignment from the Character panel menu.

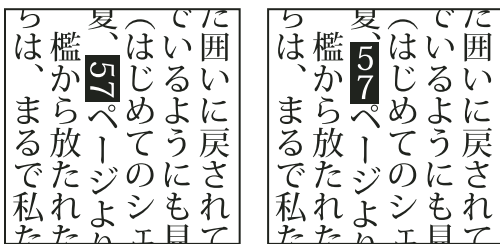

Roman text before and after rotation

More Help topics

“[Display Asian type options](#)” on page 348

“[Rotate type](#)” on page 317

Use tate-chu-yoko

Tate-chu-yoko (also called *kumimoji* and *renmoji*) is a block of horizontal type laid out within vertical type lines. Using tate-chu-yoko makes it easier to read half-width characters such as numbers, dates, and short foreign words in vertical text.

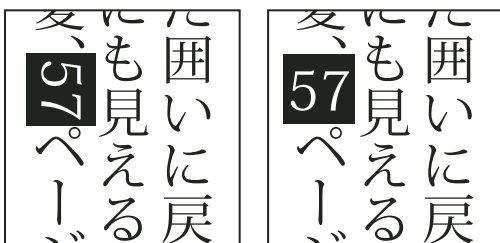

Numerals without tate-chu-yoko (left) compared to numerals rotated with tate-chu-yoko (right)

- 1 Select characters and choose Tate-chu-yoko from the Character panel menu. (Select it again to turn Tate-chu-yoko off.)
- 2 Select any of the following tate-chu-yoko settings from the Character panel menu:

Up/Down Specifies a positive value to move the text up and a negative value to move it down.

Left/Right Specifies a positive value to move the text to the right and a negative value to move it to the left.

 Use *tsume* or *tracking* in the Character panel to adjust the character spacing for tate-chu-yoko.

Note: If the Tate-chu-yoko option isn't showing, you need to select Show Asian Options in the Type preferences.

More Help topics

[“Kern and track”](#) on page 330



[“Display Asian type options”](#) on page 348

Use aki

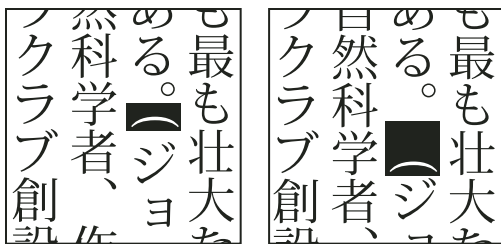
Aki is the white space before or after a character. Usually, fixed spacing is applied between the characters based on the mojikumi setting for a paragraph. You can change the mojikumi setting for special characters using the Insert Aki options in the Character panel. For example, to add a space before an opening parenthesis, use the Insert Aki (Left) option.



Parenthesis without aki (left) compared to parenthesis with aki (right)

- ❖ Select the characters you want to adjust with the Type tool, and do any of the following in the Character panel:
 - To add aki before or after a character, choose the amount of aki you want to add from the Insert Aki (Left)  or Insert Aki (Right)  menu in the Character panel. For example, if you specify 2bu, half a full-width space is added, and if you specify 4bu, a quarter of a full-width space is added.
 - To compress the aki between characters, specify a percentage for Tsume . The higher the percentage, the narrower the aki between characters.

 *If you don't see the Insert Aki or Tsume options, select Show Asian Options in the Type preferences.*

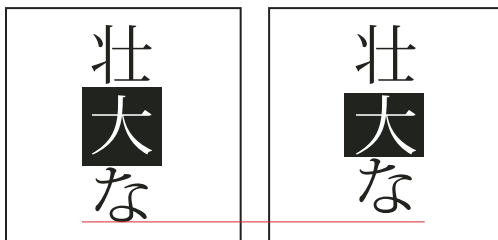

Character without tsume (left) compared to character with tsume (right)

More Help topics

[“Display Asian type options”](#) on page 348

Use warichu

The Warichu option in the Character panel decreases the typeface size of selected text to a percentage of the original and stacks the type—horizontally or vertically, according to the orientation—on multiple lines.

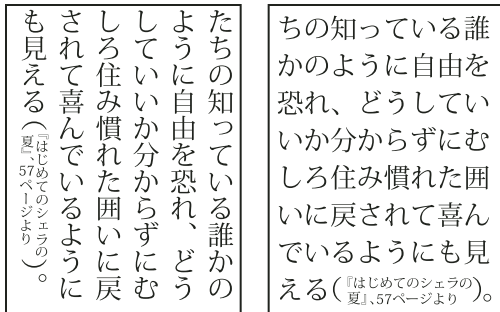
Type

Vertical and horizontal text with warichu

1 Select text and choose Warichu from the Character panel menu. (Select it again to turn it off.)

2 Select any of the following warichu settings from the Character panel menu:

Lines Specifies how many lines of text will appear as warichu characters.

Line Gap Determines the distance between the lines of warichu characters.

Scale Sets the size of warichu characters as a percentage of the size of the parent text.

Alignment Specifies the alignment of warichu characters. For example, in a vertical frame grid, selecting Top will align the beginning of the warichu characters at the top of the frame. The alignment proxy shows how the warichu text appears relative to the parent text.

Line Breaking Options Specifies the minimum number of characters required before and after the line breaks to start a new line.

More Help topics

“[Display Asian type options](#)” on page 348

Align Asian characters with mojisoro

Mojisoro is the alignment of characters in Asian type. When a line of text contains different sizes of characters, you can specify how to align text to the largest characters in the line: to the top, center, or bottom of the em box (right, center, and left for vertical frames), to the roman baseline, or to the top or bottom of the ICF box (right or left for vertical frames). *ICF* (Ideographic Character Space) is the average height and width used by the font designer to design the ideographic characters which comprise a font.

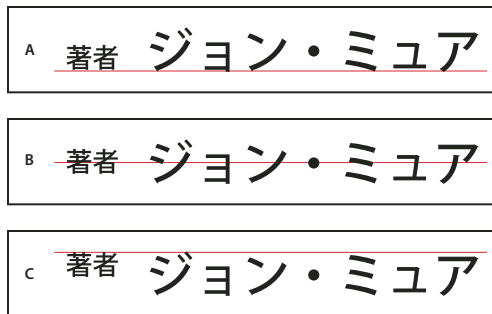
Type

Character alignment options

A. Small characters aligned to the bottom **B.** Small characters aligned to the center **C.** Small characters aligned to the top

❖ In the Character panel menu, choose an option from the Character Alignment submenu:

Roman Baseline Aligns the small characters in a line to the large character.

Em box Top/Right, Em box Center, or Em box Bottom/Left Aligns the small characters in a line to the specified position of the large character's em box. In vertical text frames, Em box Top/Right aligns the text to the right of the em box, and Em box Bottom/Left aligns the text to the left of the em box.

ICF Top/Right and ICF Bottom/Left Aligns the small characters in a line to the ICF specified by the large characters. In vertical text frames, ICF Top/Right aligns the text to the right of the ICF, and ICF Bottom/Left aligns the text to the left of the ICF.

Use mojikumi

Mojikumi specifies Japanese text composition for spacing of Japanese characters, roman characters, punctuation, special characters, line start, line end, and numbers. You can also specify paragraph indents.

The existing character spacing rules in Illustrator follow the Japanese Industrial Standards (JIS) specification, JISx4051-1995. You can select from the predefined mojikumi sets provided by Illustrator.

Furthermore, you can create specific mojikumi sets. In a new mojikumi set, you can edit the settings for spacing that you use a lot, such as the spacing between a period and subsequent opening parenthesis. For example, you might create an interview format in which you want to have an em dash before a question, and answers enclosed in parentheses.

More Help topics

[“Display Asian type options”](#) on page 348

Select a mojikumi set for a paragraph

- 1 In the Character panel, set Kerning to zero.
- 2 In the Paragraph panel, choose an option from the Mojikumi Set pop-up menu:

None Turns off the use of mojikumi.

YakumonoHankaku Uses half-width spacing for punctuation.

GyomatsuYakumonoHankaku Uses full-width spacing for most characters except the last character in the line.

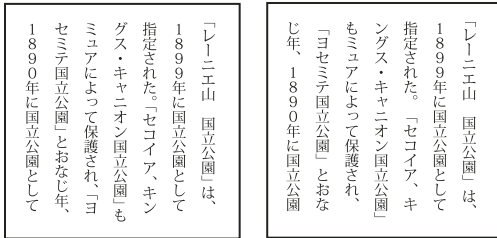
Type

YakumonoHankaku (left) and GyomatsuYakumonoHankaku (right)

GyomatsuYakumonoZenkaku Uses full-width spacing for most characters and the last character in the line.

YakumonoZenkaku Uses full-width spacing for punctuation.

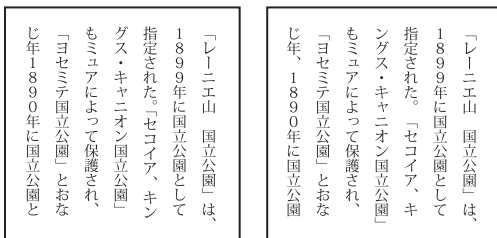

GyomatsuYakumonoZenkaku (left) and YakumonoZenkaku (right)

Create a mojikumi set

1 Do one of the following:

- Choose Type > Mojikumi Settings.
- Choose Mojikumi Settings from the Mojikumi Set pop-up menu in the Paragraph panel.

2 Click New in the Mojikumi Settings dialog box.

3 Enter a name for the new mojikumi set, specify the existing set on which the new set will be based, and click OK.

4 Choose Use Percentage (%) or Bu from the Units pop-up menu.

5 Specify Desired, Minimum, and Maximum values for each option. The Minimum value is used to compress lines for kinsoku (specify a value less than the Desired value). The Maximum value is used to spread lines for fully justified text (specify a value greater than the Desired value).



Depending on the character type, you can specify the same values for Desired, Minimum, and Maximum if you don't want to change the spacing.

6 Click Save or OK to save the settings. Click Cancel if you don't want to save the settings.



When you compose Japanese text with a lot of half-width spaces or roman parentheses, problems relating to text composition increase. We recommend that you avoid using roman parentheses, and use full-width parentheses for Japanese composition. Only use roman parentheses when using relatively long English sentences in Japanese text, or when a more serious problem results if you don't use roman parentheses.

Work with mojikumi sets

❖ In the Mojikumi Settings dialog box, do any of the following:

- To export a set, click Export, select a location for the file, type a filename, and click Save. Illustrator saves the file in MJK format.
- To import a set, click Import, select an MJK file, and click Open.

Type

- To delete a set, choose it from the Mojikumi pop-up menu and then click Delete. All the text to which the mojikumi set was applied will return to the default settings.

Note: You cannot delete predefined mojikumi sets.

Use kinsoku

Kinsoku specifies line breaks for Japanese text. Characters that cannot be placed at the beginning or end of a line are known as kinsoku characters. Illustrator has hard kinsoku sets and soft kinsoku sets and Photoshop has weak and maximum sets. Soft or weak kinsoku sets omit long vowel symbols and small hiragana characters. You can use these existing sets, or add or delete kinsoku characters to create new sets.

You can also define hanging characters for hanging Japanese punctuation and define characters that cannot be split when a line is exceeded.

You can specify whether to push in or push out text so that kinsoku characters are not placed inappropriately.

More Help topics

[“Display Asian type options”](#) on page 348

Select kinsoku settings for a paragraph

❖ In the Paragraph panel, choose an option from the Kinsoku Set pop-up menu:

None Turns off the use of kinsoku shori.

Soft or Hard Prevents selected characters from beginning or ending a line.

Create a kinsoku set

1 Do one of the following:

- Choose Type > Kinsoku Shori Settings.
- Choose Kinsoku Settings from the Kinsoku Set pop-up menu in the Paragraph panel.

2 In the Kinsoku Shori Settings dialog box, click New Set.

3 Enter a name for the kinsoku set, specify the existing set on which the new set will be based, and click OK.

4 To add a character to a field, select the field, and do one of the following:

- Enter a character in the Input box, and click Add.
- Specify the code system (Shift JIS, JIS, Kuten, or Unicode), enter the code, and click Add.

5 To delete a character in a field, select the character and click Delete. Alternatively, press Backspace (Windows) or Delete (Mac OS).

6 To check the character code currently selected, select Shift JIS, JIS, Kuten, or Unicode, and display the code system.

7 Click Save or OK to save the settings. Click Cancel if you don't want to save the settings.

Use kinsoku sets

❖ In the Kinsoku Shori Settings dialog box, do any of the following:

- To export a kinsoku set, click Export. Select a location for the file, enter a filename, and click Save.

Illustrator saves the file in KSK format.

- To import a kinsoku set, click Import. Select a KSK file, and click Open.

Type

- To delete a kinsoku set, choose the kinsoku set you want to delete from the pop-up menu. Then click Delete Set.

Note: You cannot delete predefined kinsoku settings.

Specify a kinsoku line-breaking option

Kinsoku shori or mojikumi must be selected to use the following line-breaking options.

- ❖ From the Paragraph panel menu, choose Kinsoku Shori Type and then choose one of the following methods:

Push In First Moves characters up to the previous line to prevent prohibited characters from ending or beginning a line.

Push Out First Moves characters down to the next line to prevent prohibited characters from ending or beginning a line.

Push Out Only Always moves characters down to the next line to prevent prohibited characters from ending or beginning a line. A push-in is not attempted.

A check mark indicates which method is selected.

Set bunri-kinshi on and off

When Bunri-kinshi is selected, the characters specified in the Bunri-Kinshi section of the Kinsoku Shori Settings dialog box will not be split.

- ❖ In the Paragraph panel, choose Bunri-kinshi from the panel menu.

Note: This option is only available when kinsoku shori is on.

Specify a burasagari option

Burasagari lets single-byte periods, double-byte periods, single-byte commas, and double-byte commas fall outside the paragraph bounding box.

- 1 In the Paragraph panel, choose Burasagari from the panel menu.

- 2 Choose an option from the submenu:

None Turns off hanging punctuation.

Regular Turns on hanging punctuation without forcing ragged lines to the bounding box edge.

Force Forces punctuation outside the bounding box by spreading lines that end within the bounding box and end with one of the hanging characters.

Note: The Burasagari options are not available when Kinsoku Shori is set to None.

Use kurikaeshi moji shori

You can control how repeated characters in Japanese text are handled using the Kurikaeshi Moji Shori option in the Paragraph panel. By default, a repeat character mark is substituted for the second character when two identical characters follow one after the other in a body of text. When this option is selected, both characters are displayed if they are separated by a line break.

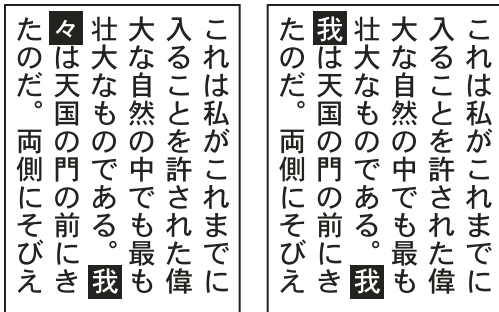
Type

Text without Kurikaeshi Moji Shori option (left) compared to text with Kurikaeshi Moji Shori option (right)

- 1 Using any type tool, select a paragraph of text to which you want to apply repeated character processing. If no text exists, the setting applies to new text typed.
- 2 In the Paragraph panel, select Kurikaeshi Moji Shori from the panel menu.

More Help topics

[“Display Asian type options”](#) on page 348

Creating composite fonts

You can mix characters from Japanese and roman fonts and use them as one composite font. Composite fonts are displayed at the beginning of the font list.

Composite fonts must be based on Japanese fonts. For example, you cannot create fonts that include Chinese or Korean fonts, nor can you use Chinese or Korean-based composite fonts copied from another application.

Create a composite font

You can mix characters from Japanese and roman fonts and use them as one composite font. Composite fonts are displayed at the beginning of the font list.

Important: *Composite fonts must be based on Japanese fonts. For example, you cannot create fonts that include Chinese or Korean fonts, nor can you use Chinese or Korean-based composite fonts copied from another application.*

- 1 Choose Type > Composite Fonts. If you don't see this command, select Show Asian Options in the Type preferences.
- 2 Click New, enter the name for the composite font, and click OK.
- 3 If you've previously saved composite fonts, you can also choose a composite font on which to base the new composite font.
- 4 Select a category of characters.

Type

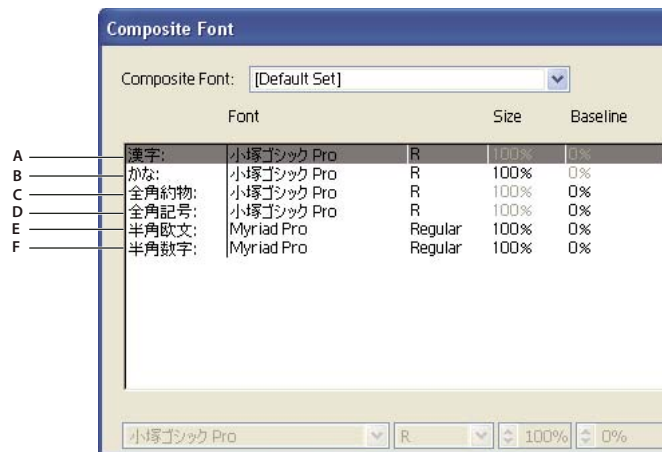

Categories of characters

A. Kanji B. Kana C. Punctuation D. Symbols E. Roman F. Numerals

- 5 Choose an option from the Units pop-up menu to specify the unit used for font attributes: % or Q.
- 6 Set font attributes for the selected category of characters. Some attributes are not available for certain categories.

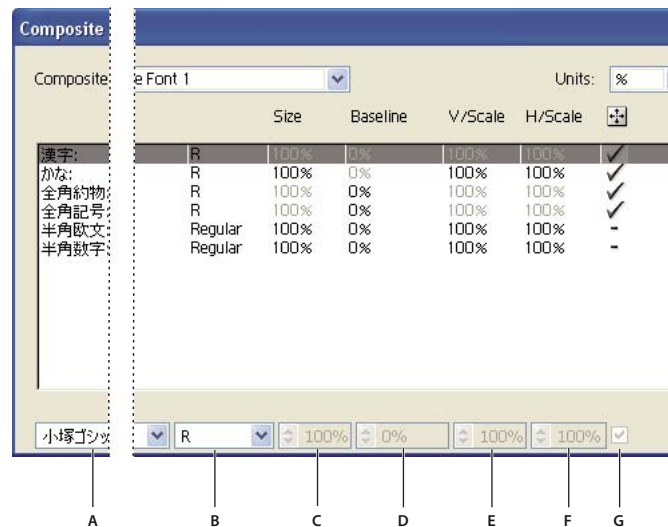

Font attributes

A. Font Family B. Font Style C. Size D. Baseline E. Vertical Scale F. Horizontal Scale G. Scale at Center

- 7 To view a sample of the composite font, click Show Sample.

You can change the sample in the following ways:

- Click the buttons on the right side of the sample to show or hide lines indicating the ICF Box 字, Embox 字, Baseline Ba, Cap Height CH, Max Ascent/Descent Ap, Max Ascender d, and x-height X.
- Choose a magnification level from the Zoom pop-up menu.

- 8 Click Save to save the settings for the composite font, and then click OK.

More Help topics

“Display Asian type options” on page 348

Type**Categories of characters in composite fonts**

Kanji The base font of the composite font. The size and baseline for other characters are set according to the sizes and baselines specified here.

Kana The font used for hiragana and katakana characters.

Punctuation The font used for punctuation.

Symbols The font used for symbols.

Roman The font used for half-width roman characters.

Numbers The font used for half-width numbers. This is usually a roman font.

Font attributes for composite fonts

Font Family And Style The font used for the characters.

Size The size of the characters in relation to the size of kanji characters. The size may differ for different fonts, even when the same font size is used.

Baseline The position of the baseline in relation to the baseline for kanji characters.

Vertical And Horizontal Scale The degree to which characters are scaled. You can scale kana characters, half-width katakana characters, gajji characters, half-width roman characters, and numbers.

Scale At Center Scaling for kana characters. When this option is selected, characters are scaled from the center. When this option is deselected, characters are scaled from the roman baseline.



*To specify the same transformation scale for all characters, specify a value for Size and fix the value for scale at 100%.
To have a different character transformation scale for horizontal and vertical, fix Size at 100%, and set Scale.*

Customize characters in a composite font

- 1 Choose Type > Composite Fonts. If you don't see this command, select Show Asian Options in the Type preferences.
- 2 Click Custom in the Composite Font dialog box.
- 3 Do one of the following:
 - If you've previously saved custom character sets, select the set you want to edit.
 - To create a custom set, click New, enter a name for the character set, and click OK. If there are existing custom sets, you can also choose a set on which to base the new set.
- 4 Do any of the following:
 - To add a character directly, choose Direct Entry from the Character pop-up menu, enter the characters in the box, and click Add.
 - To add a character using a code, choose an encoding type from the Character pop-up menu, enter the code, and click Add.

Note: You cannot add 32-bit characters to a custom set.

- To delete a character, select it in the list box, and click Delete.

- 5 When you've finished customizing the character set, click Save, and then click OK.

Note: When there are several custom characters in one composite font, the bottom set takes precedence over all the above sets.

Delete a composite font

- 1 Choose Type > Composite Fonts. If you don't see this command, select Show Asian Options in the Type preferences.
- 2 Select the composite font from the Composite Font dialog box.
- 3 Click Delete Font, and then click Yes.

Export a composite font

Composite fonts exported from Illustrator can be imported into the Japanese version of Adobe InDesign 2 or later.

- 1 Choose Type > Composite Fonts. If you don't see this command, select Show Asian Options in the Type preferences.
- 2 Click Export in the Composite Font dialog box.
- 3 Select a location for the file, enter a filename, and click Save.

Updating text from Illustrator 10

Type objects created in Illustrator 10 and earlier are uneditable until you update them for use in later versions. After you update you have access to all the text features in Illustrator CS5, such as paragraph and character styles, optical kerning, and full OpenType® font support.

Updating type created in Illustrator 10

Type objects created in Illustrator 10 and earlier are uneditable until you update them for use in later versions. After you update you have access to all the text features in Illustrator CS5, such as paragraph and character styles, optical kerning, and full OpenType® font support.

You don't have to update the text if you don't need to edit it. Text that has not been updated is called *legacy text*. You can view, move, and print legacy text, but you can't edit it. Legacy text has an x through its bounding box when selected.

After updating legacy text, you may notice some minor reflow changes. You can easily readjust the text on your own, or you can use a copy of the original text for reference. By default, Illustrator appends the word “[Converted]” to the filename whether or not you update the text in a file, effectively making a copy of your document to preserve the integrity of your original file. You can then choose to update the original later or, if you already updated it, go back to the original version.

Note: If you don't want Illustrator to append the filename, choose Edit > Preferences > General (Windows) or Illustrator > Preferences > General (Mac OS), and deselect Append [Converted] Upon Opening Legacy Files.

Update all legacy text in a document

- ❖ Do one of the following:
 - When opening the document, click Update when prompted by Illustrator.
 - After opening the document, choose Type > Legacy Text > Update All Legacy Text.

Update selected legacy text

❖ Do one of the following:

- To update the text without creating a copy, select the type object and choose Type > Legacy Text > Update Selected Legacy Text. Alternatively, select a type tool and click in the text that you want to update, or double-click the text that you want to update using the Selection tool. Then click Update.
- To preserve the legacy text on a layer below the updated text, select a type tool and click in the text that you want to update. Alternatively, double-click the text that you want to update using the Selection tool. Then click Copy Text Layer. This allows you to compare the layout of the legacy text to the updated text.

If you create a copy of legacy text when you update it, you can use the following commands:

- Type > Legacy Text > Show Copies or Hide Copies to show or hide the copied text objects.
- Type > Legacy Text > Select Copies to select copied text objects.
- Type > Legacy Text > Delete Copies to delete copied text objects.

Chapter 10: Creating special effects

Appearance attributes

You can change the appearance of any object, group, or layer in Adobe Illustrator by using effects and the Appearance and Graphic Styles panels. In addition, you can divide an object into its essential parts to modify elements of the object independently.

About appearance attributes

Appearance attributes are properties that affect the look of an object without altering its underlying structure. Appearance attributes include fills, strokes, transparency, and effects. If you apply an appearance attribute to an object and later edit or remove that attribute, it does not change the underlying object or any other attributes applied to the object.

You can set appearance attributes at any level of the layer hierarchy. For example, if you apply a drop shadow effect to a layer, all objects in the layer take on the drop shadow. However, if you move an object out of the layer, that object will no longer have a drop-shadow because the effect belongs to the layer, not to each object within the layer.

The Appearance panel is the gateway to working with appearance attributes. Because you can apply appearance attributes to layers, groups, and objects—and often to fills and strokes too—the hierarchy of attributes in your artwork can become very complex. For example, if you apply one effect to an entire layer and another effect to an object in the layer, it may be difficult to determine which effect is causing the artwork to change. The Appearance panel shows you the fills, strokes, graphic styles, and effects that have been applied to an object, group, or layer.

For a video on using the Appearance panel and the Graphics Styles panel, see www.adobe.com/go/lrvid4022_ai.

Appearance panel overview

You use the Appearance panel (Window > Appearance) to view and adjust the appearance attributes for an object, group, or layer. Fills and strokes are listed in stacking order; top to bottom in the panel correlates to front to back in the artwork. Effects are listed from top to bottom in the order in which they are applied to the artwork.

For a video on using the Appearance panel and the Graphics Styles panel, see www.adobe.com/go/lrvid4022_ai.

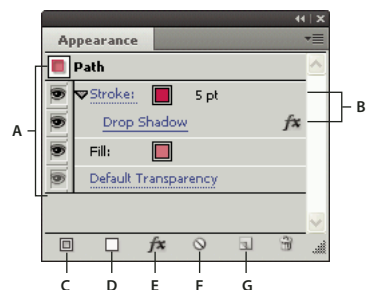

Appearance panel listing attributes of a grouped object

A. Path with stroke, fill, and drop shadow effect B. Path with effect C. Add New Stroke button D. Add New Fill button E. Add Effect button F. Clear Appearance button G. Duplicate Selected Item button

Reveal additional items in the Appearance panel

When you select items that contain other items, such as a layer or group, the Appearance panel displays a Contents item.

- ❖ Double-click the Contents item.

List character attributes for a text object in the Appearance panel

When you select a text object, the panel displays a Characters item.

- 1 Double-click the Characters item in the Appearance panel.

Note: To see individual character attributes for text with mixed appearance, select the individual character.

- 2 Click Type at the top of the panel to return to the main view.

Turn an attribute on or off for selected object

- To turn an individual attribute on or off, click the eyeball icon next to the attribute.
- To turn all hidden attributes on, choose Show All Hidden Attributes from the Appearance panel menu.

Edit an attribute

- Click in the attribute row to display and set values.
- Click the underlined text and specify new values in the dialog box that appears.

Show or hide thumbnails in the Appearance panel

- ❖ Choose Show Thumbnail or Hide Thumbnail from the Appearance panel menu.

Specify how appearance attributes are applied to new objects

You can specify whether you want new objects to inherit appearance attributes or have only basic attributes.

- To apply only a single fill and stroke to new objects, choose New Art Has Basic Appearance from the panel menu.
- To apply all of the current appearance attributes to new objects, deselect New Art Has Basic Appearance from the panel menu.

Targeting items for appearance attributes

Before you can set an appearance attribute or apply a style or an effect to a layer, group, or object, you must *target* the item in the Layers panel. Selecting an object or group using any selection method also targets the object or group in the Layers panel, but layers can be targeted only by using the panel.

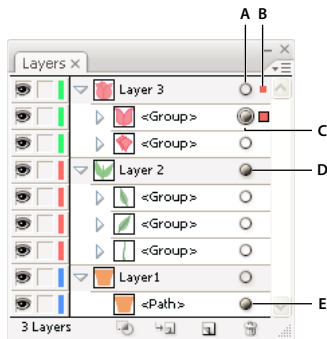

Shaded target icons in the Layers panel indicate which items contain appearance attributes.

A. Targeting and appearance column B. Selection column C. Group with appearance attributes D. Layer with appearance attributes E. Object with appearance attributes

The target icon indicates whether an item in the layer hierarchy has any appearance attributes and whether it is targeted:



- Indicates the item is not targeted and has no appearance attributes beyond a single fill and a single stroke.
- Indicates the item is not targeted but has appearance attributes.
- Indicates the item is targeted but has no appearance attributes beyond a single fill and a single stroke.
- Indicates the item is targeted and has appearance attributes.

To target an item in the Layers panel, click the item's target icon. A double ring or indicates that the item is targeted. Shift-click to target additional items.

Note: When an object or group is selected by any method, the item is also targeted in the Layers panel. In contrast, a layer can be targeted only by clicking its target icon in the Layers panel.

Edit or add an appearance attribute

You can open an appearance attribute, such as an effect, and change the settings at any time.

- ❖ In the Appearance panel, do any of the following:
 - To edit an attribute, click the blue underlined name of the attribute, and specify changes in the dialog box that appears.
 - To edit a fill color, click the fill row and choose a new color from the color box.
 - To add a new effect, click Add New Effect .
 - To delete an attribute, click the attribute row, and then click Delete .

Duplicate an appearance attribute

- ❖ Select an attribute in the Appearance panel, and do one of the following:
 - Click the Duplicate Selected Item button  in the panel, or choose Duplicate Item from the panel menu.
 - Drag the appearance attribute onto the Duplicate Selected Item button in the panel.

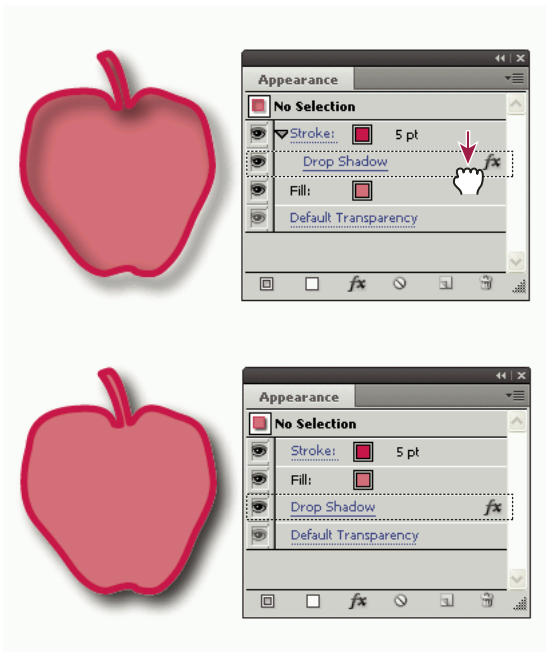

Change the stacking order of appearance attributes

- ❖ Drag an appearance attribute up or down in the Appearance panel. (If necessary, click the toggle triangle next to an item to display its contents.) When the outline of the appearance attribute you are dragging appears in the desired position, release the mouse button.



Drop Shadow effect applied to stroke (top) compared to same effect moved to fill (bottom)

Remove or hide appearance attributes

- 1 Select the object or group (or target a layer in the Layers panel).
- 2 Do one of the following:
 - To temporarily hide an attribute applied to your artwork, click the Visibility icon  in the Appearance panel. Click it again to see the attribute applied again.
 - To remove a specific attribute, select the attribute in the Appearance panel, and click the Delete icon . Alternatively, select Remove Item from the panel menu, or drag the attribute to the Delete icon.
 - To remove all appearance attributes except a single fill and stroke, choose Reduce To Basic Appearance from the panel menu. Alternatively, drag the target icon for an item in the Layers panel onto the Delete icon in the Layers panel.
 - To remove all appearance attributes, including any fill or stroke, click the Clear Appearance button  in the Appearance panel or choose Clear Appearance from the panel menu.

Copy appearance attributes between objects

You can copy or move appearance attributes by dragging or by using the Eyedropper tool.

More Help topics

[“Targeting items for appearance attributes”](#) on page 363

[“Layers panel overview”](#) on page 220

[“Appearance panel overview”](#) on page 362

Copy appearance attributes by dragging

- 1 Select the object or group (or target the layer in the Layers panel) whose appearance you want to copy.
- 2 Do one of the following:
 - Drag the thumbnail at the top of the Appearance panel onto an object in the document window. If a thumbnail isn't showing, choose Show Thumbnail from the panel menu.
 - Alt-drag (Windows) or Option-drag (Mac OS) the target icon in the Layers panel onto the item to which you want to copy appearance attributes.
 - To move appearance attributes instead of copying them, drag the target icon in the Layers panel from any item that has the desired attributes onto the item to which you want to apply it.

Copy appearance attributes using the Eyedropper tool

You can use the Eyedropper tool to copy appearance attributes from one object to another, including character, paragraph, fill, and stroke attributes between type objects. By default, the Eyedropper tool affects all attributes of a selection. To customize the attributes affected by this tool, use the Eyedropper dialog box.

- 1 Select the object, type object, or characters whose attributes you want to change.
- 2 Select the Eyedropper tool .
- 3 Move the Eyedropper tool onto the object whose attributes you want to sample. (When you're correctly positioned over type, the pointer displays a small T.)
- 4 Do one of the following:
 - Click the Eyedropper tool to sample all appearance attributes and apply them to the selected object.
 - Shift-click to sample only the color from a portion of a gradient, pattern, mesh object, or placed image and apply the color to the selected fill or stroke.
 - Hold down the Shift key and then the Alt (Windows) or Option (Mac OS) key while clicking to add the appearance attributes of an object to the selected object's appearance attributes. Alternatively, click first, and then hold down Shift+Alt (Windows) or Shift+Option (Mac OS).

Note: You can also click an unselected object to sample its attributes and Alt-click (Windows) or Option-click (Mac OS) an unselected object to which you want to apply the attributes.

Copy attributes from the desktop using the Eyedropper tool

- 1 Select the object whose attributes you want to change.
- 2 Select the Eyedropper tool.
- 3 Click anywhere on the document and continue to hold down the mouse button.
- 4 Without releasing the mouse button, move the pointer over the object on your computer desktop whose attributes you want to copy. When directly over the object, release the mouse button.

Important: The Eyedropper tool samples only the RGB color from the screen when sampling anywhere outside the current document. The Eyedropper tool indicates it is sampling RGB color from the screen by displaying a black-colored square to the right of the tool.

Specify which attributes you can copy with the Eyedropper tool

- 1 Double-click the Eyedropper tool.
- 2 Select the attributes you want to copy with the Eyedropper tool. You can sample appearance attributes including transparency, and various fill and stroke properties, as well as character and paragraph properties.
- 3 Choose the sample size area from the Raster Sample Size menu.
- 4 Click OK.

Working with effects

About effects

Illustrator includes a variety of effects, which you can apply to an object, group, or layer to change its characteristics.

Illustrator CS3 and earlier included effects and *filters*, but now Illustrator includes only effects (with the exception of SVG Filters). The primary difference between a filter and an effect is that a filter permanently modifies an object or layer, but an effect and its properties can be changed or removed at any time.

Once you apply an effect to an object, the effect appears in the Appearance panel. From the Appearance panel, you can edit the effect, move it, duplicate it, delete it, or save it as part of a graphic style. When you use an effect, you must *expand* the object before you can access the new points.

Note: Previous versions of Illustrator included filters and effects.

The effects in the top half of the Effects menu are *vector effects*. You can apply these effects only to vector objects or to the fill or stroke of a bitmap object in the Appearance panel. The following effects and effects categories from the top section are exceptions to this rule and can be applied to both vector and bitmap objects: 3D effects, SVG Filters, Warp effects, Transform effects, Drop Shadow, Feather, Inner Glow, and Outer Glow.

The effects in the bottom half of the Effects menu are *raster effects*. You can apply them to either vector or bitmap objects.

For a video on using the Appearance panel and the Graphics Styles panel, see www.adobe.com/go/lrvid4022_ai.

More Help topics

[“Effects quick reference”](#) on page 370

[“Expand objects”](#) on page 210

Apply an effect

- 1 Select the object or group (or target a layer in the Layers panel).
If you want to apply an effect to a specific attribute of an object, such as its fill or stroke, select the object and then select the attribute in the Appearance panel.
- 2 Do one of the following:
 - Choose a command from the Effect menu.
 - Click Add New Effect  in the Appearance panel, and choose an effect.
- 3 If a dialog box appears, set options, and then click OK.

 To apply the effect and settings that were used last, choose *Effect > Apply [Effect Name]*. To apply the last used effect and set its options, choose *Effect > [Effect Name]*.

More Help topics

[“Targeting items for appearance attributes”](#) on page 363

About raster effects

Raster effects are effects that generate pixels, rather than vector data. Raster effects include SVG Filters, all of the effects at the bottom section of the Effect menu, and the Drop Shadow, Inner Glow, Outer Glow, and Feather commands in the *Effect > Stylize* submenu.

The Resolution Independent Effects (RIE) capability in Illustrator CS5 makes it possible to do the following:

- When the resolution in Document Raster Effects Settings (DRES) changes, the parameters in the effect are interpreted to a different value so that there is minimal or no change in the appearance of the effect. The new modified parameter values are reflected in the Effect dialog box.
- For effects with more than one parameter, Illustrator reinterprets only those parameters that are related to the document raster effects resolution setting.

For example, there are different parameters in the Halftone Pattern dialog box. However, only the Size value changes when the DRES changes.

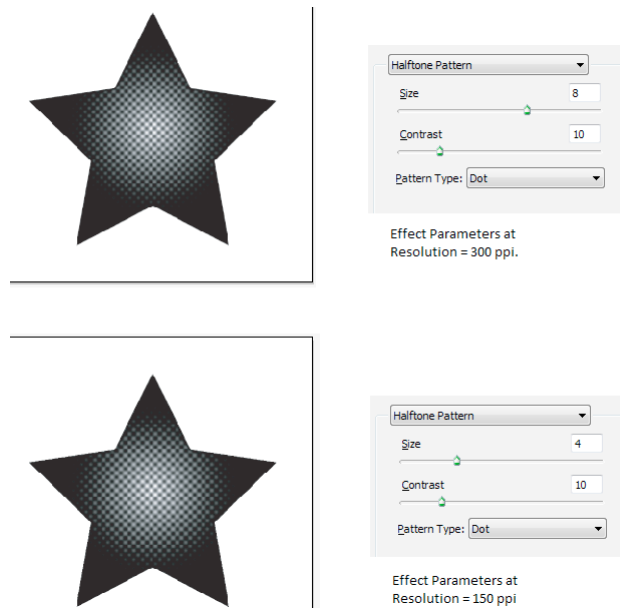

Halftone Pattern effect before and after the resolution value changes from 300 ppi to 150 ppi

You set rasterization options for a document by choosing *Effect > Document Raster Effects Settings*. (See [“Rasterization options”](#) on page 369.)

 If an effect looks good on-screen, but loses detail or appears jagged when printed, increase the document raster effects resolution.

Rasterization options

You can set the following options for all raster effects in a document or when you rasterize a vector object.

Color Model Determines the color model that is used during rasterization. You can generate an RGB or CMYK color image (depending on the color mode of your document), a grayscale image, or a 1-bit image (which may be black and white or black and transparent, depending on the background option selected).

Resolution Determines the number of pixels per inch (ppi) in the rasterized image. When rasterizing a vector object, select Use Document Raster Effects Resolution to use global resolution settings.

Background Determines how transparent areas of the vector graphic are converted to pixels. Select White to fill transparent areas with white pixels, or select Transparent to make the background transparent. If you select Transparent, you create an alpha channel (for all images except 1-bit images). The alpha channel is retained if the artwork is exported into Photoshop. (This option anti-aliases better than the Create Clipping Mask option.)

Anti-alias Applies anti-aliasing to reduce the appearance of jagged edges in the rasterized image. When setting rasterization options for a document, deselect this option to maintain the crispness of fine lines and small text.

When rasterizing a vector object, select None to apply no anti-aliasing and maintain the hard edges of line art when it is rasterized. Select Art Optimized to apply anti-aliasing that is best suited to artwork without type. Select Type Optimized to apply anti-aliasing that is best suited to type.

Create Clipping Mask Creates a mask that makes the background of the rasterized image appear transparent. You do not need to create a clipping mask if you selected Transparent for Background.

Add Around Object Adds a padding or border around the rasterized image, using the specified number of pixels. The resulting image's dimensions appear as the original dimensions plus the Add Around Object setting's value. You can use this setting, for example, to create a snapshot effect: Specify a value for Add Around Object setting, choose White Background, and do not select Create Clipping Mask. The white boundary added to the original object becomes a visible border on the image. You can then apply a Drop Shadow or Outer Glow effect to make the original artwork look like a photo.

More Help topics

[“About raster effects”](#) on page 368

[“Rasterize a vector object”](#) on page 283

[“Image resolution guidelines for final output”](#) on page 272

Applying effects to bitmap images

Effects let you apply a special look to bitmap images as well as vector objects. For example, you can apply an impressionistic look, apply lighting changes, distort images, and produce many other interesting visual effects.

Consider the following information when applying effects specifically to bitmap objects:

- Effects do not work on linked bitmap objects. If you apply an effect to a linked bitmap, it is applied to an embedded copy of the bitmap instead of to the original. To apply the effect to the original, you must embed the original bitmap in the document.
- Adobe Illustrator supports plug-in effects from Adobe products such as Adobe Photoshop and from non-Adobe software developers. Once installed, most plug-in effects appear in the Effect menu and work the same way as do built-in effects.
- Some effects can be memory-intensive, especially when applied to a high-resolution bitmap image.

More Help topics

[“About linked and embedded artwork”](#) on page 267

[“About plug-in modules”](#) on page 48

Improving performance for effects

Some effects are very memory-intensive. The following techniques can help improve performance when applying these effects:

- Select the Preview option in effect dialog boxes to save time and prevent unintended results.
- Change the settings. Some commands, such as Glass, are extremely memory-intensive. Try different settings to increase their speed.
- If you plan to print to a grayscale printer, convert a copy of the bitmap image to grayscale before applying effects. Note, however, that in some cases, applying an effect to a color bitmap image and then converting it to grayscale may not have the same result as applying the same effect directly to a grayscale version of the image.

Modify or delete an effect

You modify or delete an effect by using the Appearance panel.

- 1 Select the object or group (or target the layer in the Layers panel) that uses the effect.
- 2 Do one of the following:
 - To modify the effect, click its blue underlined name in the Appearance panel. In the effect’s dialog box, make the desired alterations, and then click OK.
 - To delete the effect, select the effect listing in the Appearance panel, and click the Delete button.

Summary of effects

Effects quick reference

Effect	Action
Effect > 3D	Convert open or closed paths, or bitmap objects, into three-dimensional (3D) objects, which you can rotate, light, and shade. See also: “Create 3D objects” on page 259
Effect > Artistic	Simulate a painterly appearance on traditional media. See also: “Artistic effects” on page 372
Effect > Blur	Retouch images and smooth transitions by averaging the pixels next to the hard edges of defined lines and shaded areas in an image. See also: “Blur effects” on page 373
Effect > Brush Strokes	Create a painterly or fine-arts look using different brush- and ink- stroke effects. See also: “Brush Strokes effects” on page 373
Effect > Convert To Shape	Reshape either a vector or a bitmap object. See also: “Reshaping objects with effects” on page 254

Effect	Action
Effect > Crop Marks	Applies crop marks to the selected object. See also: “Specify crop marks for trimming or aligning” on page 46
Effect > Distort & Transform (top section of menu)	Reshape vector objects, or apply the effects to a fill or stroke added to a bitmap object with the Appearance panel. See also: “Reshaping objects with effects” on page 254
Effect > Distort (bottom section of menu)	Geometrically distort and reshape an image. See also: “Distort effects (bottom of menu)” on page 374
Effect > Path	Offset an object’s path relative to its original location, turn type into a set of compound paths that you can edit and manipulate as you would any other graphic object, and change the stroke of a selected object to a filled object that’s the same width as the original stroke. You can also apply these commands to a fill or stroke added to a bitmap object with the Appearance panel. See also: “Offset duplicate objects” on page 228, “Convert type to outlines” on page 327, “Convert strokes to compound paths” on page 156
Effect > Pathfinder	Combine groups, layers, or sublayers into single editable objects. See also: “Apply Pathfinder effects” on page 241
Effect > Pixelate	Sharply define a selection by clumping pixels of similar color values. See also: “Pixelate effects” on page 374
Effect > Rasterize	Convert a vector object to a bitmap object. See also: “Rasterize a vector object” on page 283
Effect > Sharpen	Focus blurry images by increasing the contrast of adjacent pixels. See also: “Sharpen effect” on page 374
Effect > Sketch	Add texture to images, often for a three-dimensional effect. The effects are also useful for creating a fine-arts or hand-drawn look. See also: “Sketch effects” on page 375
Effect > Stylize (top section of menu)	Add arrowheads, drop shadows, round corners, feathered-edged, glowing, and scribble-styled appearances to objects. See also: “Create a drop shadow” on page 377, “Apply an inner or outer glow” on page 377, “Add arrowheads” on page 154, “Feather the edges of an object” on page 378, “Create a sketch using the Scribble effect” on page 378, “Round the corners of objects” on page 254
Effect > Stylize (bottom section of menu)	The Glowing Edges command produces a painted or impressionistic effect on a selection by displacing pixels and by finding and heightening contrast in an image. See also: “Stylize effect (bottom of menu)” on page 375
Effect > SVG Filters	Add XML-based graphic properties such as drop shadows to your artwork. See also: “Apply SVG effects” on page 393
Effect > Texture	Give an image the appearance of depth or substance, or add an organic look. See also: “Texture effects” on page 376
Effect > Video	Optimize images captured from video or artwork intended for television. See also: “Video effects” on page 376
Effect > Warp	Distort or deform objects, including paths, text, meshes, blends, and raster images. See also: “Reshaping objects with effects” on page 254

Artistic effects

Artistic effects are raster-based and use the document's raster effects settings whenever you apply the effect to a vector object.

Colored Pencil Draws an image using colored pencils on a solid background. Important edges are retained and given a rough crosshatch appearance; the solid background color shows through the smoother areas.

Cutout Portrays an image as though it were made from roughly cut-out pieces of colored paper. High-contrast images appear as if in silhouette; colored images are built up as if from several layers of colored paper.

Dry Brush Paints the edges of the image using a dry-brush technique (between oil and watercolor). The effect simplifies an image by reducing its range of colors.

Film Grain Applies an even pattern to the shadow tones and midtones of an image. A smoother, more saturated pattern is added to the image's lighter areas. This effect is useful for eliminating banding in blends and visually unifying elements from various sources.

Fresco Paints an image in a coarse manner using short, rounded strokes as if hastily applied.

Neon Glow Adds various types of glows to the objects in an image. This effect is useful for colorizing an image while softening its look. To select a glow color, click the glow box and select a color from the color picker.

Paint Daubs Lets you choose from various brush sizes (from 1 to 50) and types for a painterly effect. Brush types include simple, light rough, light dark, wide sharp, wide blurry, and sparkle.

Palette Knife Reduces detail in an image to give the effect of a thinly painted canvas that reveals the texture underneath.

Plastic Wrap Coats the image as if in shiny plastic, accentuating the surface detail.

Poster Edges Reduces the number of colors in an image according to the Posterization value you set; then finds the edges of the image and draws black lines on them. Broader areas of the image have simple shading, while fine, dark detail is distributed throughout the image.

Rough Pastels Makes an image appear as if stroked with colored pastel chalk on a textured background. In areas of bright color, the chalk appears thick with little texture; in darker areas, the chalk appears scraped off to reveal the texture.

Smudge Stick Softens an image using short diagonal strokes to smudge or smear the darker areas of the images. Lighter areas become brighter and lose detail.

Sponge Creates images with highly textured areas of contrasting color as if painted with a sponge.

Underpainting Paints the image on a textured background, and then paints the final image over it.

Watercolor Paints the image in a watercolor style, simplifying details, and using a medium brush loaded with water and color. Where significant tonal changes occur at edges, the effect saturates the color.

More Help topics

[“Effects quick reference”](#) on page 370

[“Use texture and glass surface controls”](#) on page 376

Blur effects

The commands in the Blur submenu in the Effect menu are raster-based and use the document's raster effects settings whenever you apply the effect to a vector object.

Gaussian Blur Quickly blurs a selection by an adjustable amount. This effect removes high-frequency detail and can produce a hazy effect.

Radial Blur Simulates the soft blur created by a zooming or rotating camera. Choose Spin to blur along concentric circular lines, and then specify a degree of rotation. Choose Zoom to blur along radial lines, as if zooming in or out of the image, and specify an amount from 1 to 100. Blur quality ranges from Draft for the fastest but grainy results to Good and Best for smoother results, which are indistinguishable except on a large selection. Specify the origin of the blur by dragging the pattern in the Blur Center box.

Smart Blur Blurs an image with precision. You can specify a radius, a threshold, and a blur quality. The Radius value determines the size of the area searched for dissimilar pixels. The Threshold value determines how dissimilar the pixels must be before they are affected. You also can set a mode for the entire selection (Normal) or for the edges of color transitions (Edge Only and Overlay). Where significant contrast occurs, Edge Only applies black-and-white edges, and Overlay Edge applies white.

More Help topics

[“Effects quick reference”](#) on page 370

Brush Strokes effects

The Brush Strokes effects are raster-based and use the document's raster effects settings whenever you apply the effect to a vector object.

Accented Edges Accentuates the edges of an image. When the Edge Brightness control is set to a high value, the accents resemble white chalk. When it is set to a low value, the accents resemble black ink.

Angled Strokes Repaints an image using diagonal strokes. The lighter areas of the image are painted in strokes going in one direction, while the darker areas are painted in strokes going the opposite direction.

Crosshatch Preserves the details and features of the original image while adding texture and roughening the edges of the colored areas in the image with simulated pencil hatching. The Strength option controls the number of hatching passes (from 1 to 3).

Dark Strokes Paints dark areas of an image closer to black with short strokes, and paints lighter areas of the image with long, white strokes.

Ink Outlines Redraws an image with fine narrow lines over the original details, in pen-and-ink style.

Spatter Replicates the effect of a spatter airbrush. Increasing the values of the options simplifies the overall effect.

Sprayed Strokes Repaints an image using its dominant colors with angled, sprayed strokes of color.

Sumi-e Paints an image in Japanese style as if with a wet brush full of black ink on rice paper. The effect is soft, blurry edges with rich blacks.

More Help topics

[“Effects quick reference”](#) on page 370

Distort effects (bottom of menu)

The Distort commands can be very memory-intensive. They are raster-based and use the document's raster effects settings whenever you apply the effect to a vector object.

Diffuse Glow Renders an image as if it were being viewed through a soft diffusion filter. The effect adds see-through white noise to an image, with the glow fading from the center of a selection.

Glass Makes an image appear as if it were being viewed through different types of glass. You can choose a preset glass effect or create your own glass surface using a Photoshop file. You can adjust scaling, distortion, and smoothness settings, as well as texturizing options.

Ocean Ripple Adds randomly spaced ripples to the artwork, making the artwork look as if it were under water.

More Help topics

[“Use texture and glass surface controls”](#) on page 376

[“Effects quick reference”](#) on page 370

Pixelate effects

The Pixelate effects are raster-based and use the document's raster effects settings whenever you apply the effect to a vector object.

Color Halftone Simulates the effect of using an enlarged halftone screen on each channel of the image. For each channel, the effect divides the image into rectangles and replaces each rectangle with a circle. The circle size is proportional to the brightness of the rectangle.

To use the effect, enter a value in pixels for the maximum radius of a halftone dot (from 4 to 127), and enter a screen-angle value (the angle of the dot relative to the true horizontal) for one or more channels. For Grayscale images, use only channel 1. For RGB images, use channels 1, 2, and 3, which correspond to the red, green, and blue channels. For CMYK images, use all four channels, which correspond to the cyan, magenta, yellow, and black channels.

Crystallize Clumps colors into polygon shapes.

Mezzotint Converts an image to a random pattern of black-and-white areas, or of fully saturated colors in a color image. To use the effect, choose a dot pattern from the Type pop-up menu in the Mezzotint dialog box.

Pointillize Breaks up the color in an image into randomly placed dots, as in a pointillist painting, and uses the background color as a canvas area between the dots.

More Help topics

[“Effects quick reference”](#) on page 370

Sharpen effect

The Unsharp Mask command in the Sharpen submenu in the Effect menu focuses blurry images by increasing the contrast of adjacent pixels. This effect is raster-based and uses the document's raster effects settings whenever you apply the effect to a vector graphic.

Unsharp Mask Finds the areas in the image where significant color changes occur and sharpens them. Use the Unsharp Mask effect to adjust the contrast of edge detail and produce a lighter and darker line on each side of the edge. This effect emphasizes the edge and creates the illusion of a sharper image.

More Help topics

[“Effects quick reference”](#) on page 370

Sketch effects

Many of the Sketch effects use black and white colors to redraw the image. The effects are raster-based and use the document’s raster effects settings whenever you apply the effect to a vector graphic.

Bas Relief Transforms an image to appear carved in low relief and lit to accent the surface variations. Dark areas of the image are colored black; light colors are colored white.

Chalk & Charcoal Redraws an image’s highlights and midtones with a solid midtone gray background drawn in coarse chalk. Shadow areas are replaced with diagonal charcoal lines. The charcoal is drawn in black, the chalk in white.

Charcoal Redraws an image to create a posterized, smudged effect. Major edges are drawn boldly while midtones are sketched using a diagonal stroke. Charcoal is colored black; the paper is colored white.

Chrome Treats the image as if it were a polished chrome surface. Highlights are high points and shadows are low points in the reflecting surface.

Conté Crayon Replicates the texture of dense dark and pure white Conté crayons on an image. The Conté Crayon effect uses black for dark areas and the white for light areas.

Graphic Pen Uses fine, linear ink strokes to capture the details in the original image. The effect replaces color in the original image using black for ink and white for paper. This command is especially striking with scanned images.

Halftone Pattern Simulates the effect of a halftone screen while maintaining the continuous range of tones.

Note Paper Creates an image that appears to be constructed of handmade paper. The effect simplifies an image, and combines the effect of the Grain command (Texture submenu) with an embossed appearance. Dark areas of the image appear as holes in the top layer of paper surrounded by white.

Photocopy Simulates the effect of photocopying an image. Large areas of darkness tend to copy only around their edges; midtones fall away to either solid black or white.

Plaster Molds an image as if from plaster, and then colorizes the result using black and white. Dark areas are raised; light areas are sunken.

Reticulation Simulates the controlled shrinking and distorting of film emulsion to create an image that appears clumped in the shadow areas and lightly grained in the highlights.

Stamp Simplifies the image to appear stamped with a rubber or wood stamp. This command is best used with black-and-white images.

Torn Edges Reconstructs the image as ragged, torn pieces of paper, and then colorizes the image using black and white. This command is useful for images consisting of text or high-contrast objects.

Water Paper Uses blotchy daubs that appear painted onto fibrous, damp paper, causing the colors to flow and blend.

More Help topics

[“Effects quick reference”](#) on page 370

Stylize effect (bottom of menu)

The Glowing Edges effect is raster-based and uses the document’s raster effects settings whenever you apply the effect to a vector graphic.

Glowing Edges Identifies the edges of color and adds a neon-like glow to them.

More Help topics

[“Effects quick reference”](#) on page 370

Texture effects

The Texture effects are raster-based and use the document’s raster effects settings whenever you apply the effect to a vector graphic.

Craquelure Paints an image onto a high-relief plaster surface, producing a fine network of cracks that follow the contours of the image. Use this effect to create an embossing effect with images that contain a broad range of color or grayscale values.

Grain Adds texture to an image by simulating different kinds of grain—regular, soft, sprinkles, clumped, contrasty, enlarged, stippled, horizontal, vertical, or speckle. For more information on using these texturizing options, see [“Use texture and glass surface controls”](#) on page 376.

Mosaic Tiles Draws the image as if it were made up of small chips or tiles and adds grout between the tiles. (In contrast, the Pixelate > Mosaic command breaks up an image into blocks of different-colored pixels.)

Patchwork Breaks up an image into squares filled with the predominant color in that area of the image. The effect randomly reduces or increases the tile depth to replicate highlights and shadows.

Stained Glass Repaints an image as single-colored adjacent cells outlined in the foreground color.

Texturizer Applies a texture you select or create to an image.

More Help topics

[“Effects quick reference”](#) on page 370

Video effects

The Video effects are raster-based and use the document’s raster effects settings whenever you apply the effect to a vector graphic.

De-Interlace Smooths moving images captured on video by removing either the odd or even interlaced lines in a video image. You can choose to replace the discarded lines by duplication or interpolation.

NTSC Colors Restricts the gamut of colors to those acceptable for television reproduction to prevent oversaturated colors from bleeding across television scan lines.

More Help topics

[“Effects quick reference”](#) on page 370

Use texture and glass surface controls

Some effects included in Illustrator have texturizing options, such as the Glass, Rough Pastels, Grain, and Fresco effects. The texturizing options can make an object appear as though painted onto various textures, such as canvas or brick, or viewed through glass blocks.

- 1 In the effect’s dialog box, choose a texture type from the Texture pop-up menu (if available), or choose Load Texture (only available for Rough Pastels or Glass commands) to specify a file.
- 2 Set other options, if available:
 - Drag the Scaling slider to enlarge or reduce the effect on the bitmap image’s surface.

- Drag the Relief slider to adjust the depth of the texture's surface.
- From the Light Direction pop-up menu, choose the direction from which you want the light to appear.
- Select Invert to reverse the surface's light and dark colors.

Drop shadows, glows, and feathering

Create a drop shadow

- 1 Select an object or group (or target a layer in the Layers panel).
- 2 Choose Effect > Stylize > Drop Shadow.
- 3 Set options for the drop shadow, and click OK:

Mode Specifies a blending mode for the drop shadow.

Opacity Specifies the percentage of opacity you want for the drop shadow.

X Offset and Y Offset Specifies the distance you want the drop shadow to be offset from the object.

Blur Specifies the distance from the edge of the shadow where you want any blurring to occur. Illustrator creates a transparent raster object to simulate the blur.

Color Specifies a color for the shadow.

Darkness Specifies the percentage of black you want added for the drop shadow. In a CMYK document, a value of 100%, used with a selected object that contains a fill or stroke color other than black, creates a multicolored black shadow. A value of 100% used with a selected object that contains only a black fill or stroke creates a 100% black shadow. A value of 0% creates a drop shadow the color of the selected object.

More Help topics

[“Targeting items for appearance attributes”](#) on page 363

[“Selecting objects”](#) on page 201

[“About effects”](#) on page 367

[“About blending modes”](#) on page 186

Apply an inner or outer glow

- 1 Select an object or group (or target a layer in the Layers panel).
- 2 Choose Effect > Stylize > Inner Glow or Effect > Stylize > Outer Glow.
- 3 Click the color preview square next to the blending mode menu to specify a color for the glow.
- 4 Set additional options, and click OK:

Mode Specifies a blending mode for the glow.

Opacity Specifies the percentage of opacity you want for the glow.

Blur Specifies the distance from the center or edge of the selection where you want any blurring to occur.

Center (Inner Glow only) Applies a glow that emanates from the center of the selection.

Edge (Inner Glow only) Applies a glow that emanates from the inside edges of the selection.

💡 *When you expand an object that uses an inner-glow effect, the inner glow reveals itself as an opacity mask. If you expand an object that uses an outer glow, the outer glow becomes a transparent raster object.*

More Help topics

[“Targeting items for appearance attributes”](#) on page 363

[“Selecting objects”](#) on page 201

[“About effects”](#) on page 367

[“About blending modes”](#) on page 186

Feather the edges of an object

- 1 Select the object or group (or target a layer in the Layers panel).
- 2 Choose Effect > Stylize > Feather.
- 3 Set the distance over which the object fades from opaque to transparent, and click OK.

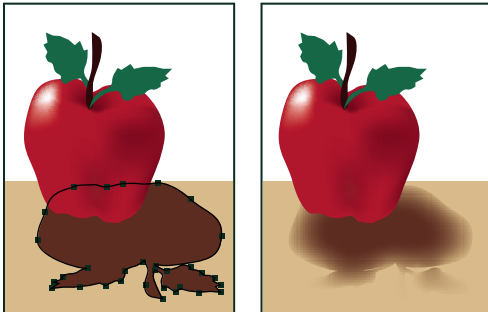

Original object selected (left) and using feather effect (right)

More Help topics

[“About effects”](#) on page 367

[“Targeting items for appearance attributes”](#) on page 363

[“About raster effects”](#) on page 368

[“Selecting objects”](#) on page 201

Creating sketches and mosaics

Create a sketch using the Scribble effect

- 1 Do one of the following:
 - Select the object or group (or target a layer in the Layers panel).
 - To apply the effect to a specific object attribute, such as a stroke or fill, select the object, and then select the attribute in the Appearance panel.
 - To apply the effect to a graphic style, select a graphic style in the Graphic Styles panel.
- 2 Choose Effect > Stylize > Scribble.

3 Do one of the following:

- To use a preset scribble effect, choose one from the Settings menu.
- To create a custom scribble effect, begin with any preset, and then adjust the Scribble options.

4 If creating a custom scribble, adjust any of the following Scribble options and click OK:

Angle Controls the direction of the scribble lines. You can click any point on the angle icon, drag the angle line around the angle icon, or enter a value between -179 and 180 in the box. (If you enter a value that's outside that range, the value is translated to its equivalent in-range value.)

Path Overlap Controls the amount the scribble lines stay within or extend beyond the path boundaries. A negative value constrains the scribble lines within the path boundary and a positive value extends the scribble lines beyond the path boundary.

Variation (for Path Overlap) Controls the lengths of the difference in scribble line lengths relative to each other.

Stroke Width Controls the width of the scribble lines.

Curviness Controls the amount the scribble lines curve before they reverse direction.

Variation (for Curviness) Controls how different the scribble line curves are relative to each other.

Spacing Controls the amount of space between scribble line folds.

Variation (for Spacing) Controls how different the amount of space is between scribble line folds.

More Help topics

[“Targeting items for appearance attributes”](#) on page 363

[“About effects”](#) on page 367

[“Modify or delete an effect”](#) on page 370

[“Selecting objects”](#) on page 201

Create a mosaic

1 Import a bitmap image to use as the basis for the mosaic. The image must be embedded, not linked.

You can also rasterize a vector object to use it as the basis for the mosaic.

2 Select the image.

3 Choose Object > Create Object Mosaic.

4 If you want to change the dimensions of the mosaic, enter values for New Size.

5 Set options to control the spacing between tiles and the total number of tiles, along with any other additional options, and click OK:

Constrain Ratio Locks the width or height dimensions to the dimensions of the original bitmap image. Width calculates the appropriate number of tiles to use for the width of the mosaic, based on the original number of tiles for the width. Height calculates the appropriate number of tiles to use for the height of the mosaic, based on the original number of tiles for the height.

Result Specifies whether the mosaic tiles are color or grayscale.

Resize Using Percentages Changes the size of the image by percentages of width and height.

Delete Raster Deletes the original bitmap image.

Use Ratio Makes the tiles square, using the number of tiles specified in Number Of Tiles. This option is located below the Cancel button.

More Help topics

“[Rasterize a vector object](#)” on page 283

“[About linked and embedded artwork](#)” on page 267

Graphic styles

About graphic styles

A graphic style is a set of reusable appearance attributes. Graphic styles allow you to quickly change the look of an object; for example, you can change its fill and stroke color, alter its transparency, and apply effects in one step. All the changes you apply with graphic styles are completely reversible.

You can apply graphic styles to objects, groups, and layers. When you apply a graphic style to a group or layer, every object in the group or layer takes on the attributes of the graphic style. For example, assume you have a graphic style that consists of 50% opacity. If you apply the graphic style to a layer, all objects in or added to that layer will appear 50% opaque. However, if you move an object out of the layer, the object’s appearance reverts to its previous opacity.

For a video on using the Appearance panel and the Graphics Styles panel, see www.adobe.com/go/lrvid4022_ai.

 *If you apply a graphic style to a group or layer, but the style’s fill color doesn’t appear in the artwork, drag the Fill attribute above the Contents entry in the Appearance panel.*

Graphic Styles panel overview

You use the Graphic Styles panel (Window > Graphic Styles) to create, name, and apply sets of appearance attributes. The panel lists a default set of graphic styles when you create a document. Graphic styles that are saved with the active document appear in the panel when that document is open and active.

If a style doesn’t have a fill and stroke (for example, an effect-only style) the thumbnail appears in the shape of the object with a black outline and white fill. In addition, a little red slash appears, indicating the absence of a fill or stroke.

If you’ve created a style for type, choose Use Text For Preview from the Graphics Styles panel menu to see a thumbnail of the style applied to a letter rather than a square.

To see any style more clearly, or to preview the style on a selected object, right-click (Windows) or Ctrl-click (Mac OS) the style’s thumbnail in the Graphic Styles panel and view the large pop-up thumbnail that appears.

For a video on using the Appearance panel and the Graphics Styles panel, see www.adobe.com/go/lrvid4022_ai.

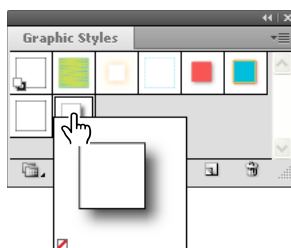

Right-click style thumbnail to view large pop-up thumbnail. Selected style is an effect-only style.

Change how graphic styles are listed in the panel

- ❖ Do any of the following:
 - Select a view size option from the panel menu. Select Thumbnail View to display thumbnails. Select Small List View to display a list of named styles with a small thumbnail. Select Large List View to display a list of named styles along with a large thumbnail.
 - Select Use Square For Preview from the panel menu to view the style on a square or the shape of the object on which it was created.
 - Drag the graphic style to a different position. When a black line appears in the desired position, release the mouse button.
 - Select Sort By Name from the panel menu to list the graphic styles in alphabetic or numeric order (Unicode order).
 - Select Use Text For Preview from the panel menu to view the style on the letter T. This view provides a more accurate visual description for styles applied to text.

Sample text



Graphic style for type using text for the preview

Create graphic styles

You can create a graphic from scratch by applying appearance attributes to an object, or you can base a graphic style on other graphic styles. You can also duplicate existing graphic styles.

Create a graphic style

- 1 Select an object and apply any combination of appearance attributes, including fills and strokes, effects, and transparency settings.

You can use the Appearance panel to adjust and order the appearance attributes and create multiple fills and strokes. For example, you can have three fills in a graphic style, each with a different opacity and blending mode that defines how the various colors interact.

- 2 Do any of the following:
 - Click the New Graphic Style button  in the Graphic Styles panel.
 - Select New Graphic Style from the panel menu, type a name in the Style Name box, and click OK.
 - Drag the thumbnail from the Appearance panel (or the object from the illustration window) into the Graphic Styles panel.
 - Alt-click (Windows) or Option-click (Mac OS) the New Graphic Style button, enter the name of the graphic style, and click OK.

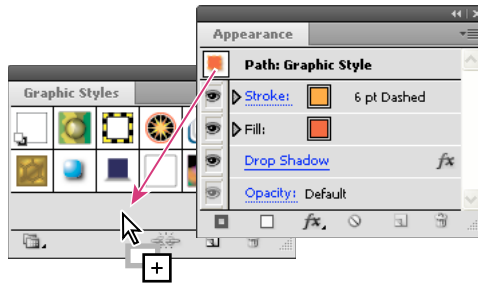

Drag the thumbnail from the Appearance panel to the Graphic Styles panel to save the attributes.

Create a graphic style based on two or more existing graphic styles

- ❖ Ctrl-click (Windows) or Command-click (Mac OS) to select all the graphic styles you want to merge, and then choose Merge Graphic Styles from the panel menu.

The new graphic style contains all the attributes of the selected graphic styles and is added to the end of the list of graphic styles in the panel.

Duplicate a graphic style

- ❖ Choose Duplicate Graphic Style from the panel menu, or drag the graphic style onto the New Graphic Style button.

The new graphic style appears at the bottom of the list in the Graphic Styles panel.

Apply a graphic style

- 1 Select an object or group (or target a layer in the Layers panel).
- 2 To apply a single style to an object, do either of the following:
 - Select a style from the Styles menu in the Control panel, the Graphic Styles panel, or a graphic style library.
 - Drag the graphic style onto an object in the document window. (The object does not have to be selected first.)
- 3 To merge a style with an object's existing style attributes, or apply multiple styles to an object, do either of the following:
 - Alt-drag (Windows) or Option-drag (Mac OS) the style from the Graphic Styles panel to the object.
 - Select the object, and then Alt-click (Windows) or Option-click (Mac OS) the style in the Graphic Styles panel.

Note: To preserve the color of type when applying a graphic style, deselect Override Character Color in the Graphic Styles panel menu.

Use graphic style libraries

Graphic style libraries are collections of preset graphic styles. When you open a graphic style library, it appears in a new panel (not the Graphic Styles panel). You select, sort, and view items in a graphic style library the same as you do in the Graphic Styles panel. However, you can't add items to, delete items from, or edit the items in graphic style libraries.

Open a graphic style library

- ❖ Select a library from the Window > Graphic Style Libraries submenu or the Open Graphic Style Library submenu in the Graphic Styles panel menu.



To automatically open a library when you start Illustrator, choose Persistent from the library's panel menu.

Create a graphic style library

- 1 Add the graphic styles you want to the Graphic Styles panel, and delete any graphic styles you don't want.



To select all graphic styles that aren't used in a document, choose Select All Unused from the Graphic Styles panel menu.

- 2 Choose Save Graphic Style Library from the Graphic Styles panel menu.

You can save the library anywhere. However, if you save the library file in the default location, the library name will appear in the User Defined submenu of the Graphic Style Libraries and Open Graphic Style Library menu.

Move graphic styles from a library to the Graphic Styles panel

- Drag one or more graphic styles from the graphic styles library to the Graphic Styles panel.
- Select the graphic styles you want to add, and select Add To Graphic Styles from the library's panel menu.
- Apply a graphic style to an object in the document. The graphic style is automatically added to the Graphic Styles panel.

Work with graphic styles

In the Graphic Styles panel, you can rename or delete graphic styles, break the link to a graphic style, and replace graphic style attributes.

Rename a graphic style

- ❖ Choose Graphic Style Options from the panel menu, rename the file, and then click OK.

Delete a graphic style

- ❖ Choose Delete Graphic Style from the panel menu and click Yes, or drag the style onto the Delete icon.

Any objects, groups, or layers that used the graphic style retain the same appearance attributes; however, these attributes are no longer associated with a graphic style.

Break the link to a graphic style

- 1 Select the object, group, or layer that has the graphic style applied to it.
- 2 Do one of the following:
 - Choose Break Link To Graphic Style from the Graphic Styles panel menu, or click the Break Link To Graphic Style button  in the panel.
 - Change any appearance attribute of the selection (such as a fill, stroke, transparency, or effect).

The object, group, or layer retains the same appearance attributes and is now independently editable. However, these attributes are no longer associated with a graphic style.

Replace graphic style attributes

- Alt-drag (Windows) or Option-drag (Mac OS) the graphic style you want to use onto the graphic style you want to replace.
- Select an object or group (or target a layer in the Layers panel) that has the attributes you want to use. Then Alt-drag (Windows) or Option-drag (Mac OS) the thumbnail at the top of the Appearance panel onto the graphic style you want to replace in the Graphic Styles panel.
- Select the graphic style you want to replace. Then select artwork (or target an item in the Layers panel) that has the attributes you want to use, and choose Redefine Graphic Style "Style name" from the Appearance panel menu.

The replaced graphic style keeps its name but takes on new appearance attributes. All occurrences of the graphic style in the Illustrator document are updated to use the new attributes.

Import all graphic styles from another document

- 1 Choose Window > Graphic Style Libraries > Other Library or select Open Graphic Style Library > Other Library from the Graphic Styles panel menu.
- 2 Select the file from which you want to import graphic styles, and click Open.

The graphic styles appear in a graphic style library panel (not the Graphic Styles panel).

Chapter 11: Web graphics

Best practices for creating web graphics

Illustrator provides a variety of tools for creating layout for web pages, or creating and optimizing web graphics. For example, use web-safe colors, balance image quality with file size, and choose the best file format for your graphic. Web graphics can take advantage of slices and image maps, and you can use a variety of optimization options and work with Device Central to ensure your files display well on the web.

About web graphics

When designing graphics for the web, you must consider different issues than when designing graphics for print. For a video on saving graphics for the web, see www.adobe.com/go/vid0063. For a video on importing, and copying and pasting between web applications, see www.adobe.com/go/vid0193.

To help you make informed decisions about web graphics, keep in mind the following three guidelines:

1. Use web-safe colors.

Color is often a key aspect of artwork. However, the colors you see on your artboard aren't necessarily the colors that will appear in a web browser on someone else's system. You can prevent dithering (the method of simulating unavailable colors) and other color problems by taking two precautionary steps when creating web graphics. First, always work in RGB color mode. Second, use a web-safe color.

2. Balance image quality with file size.

Creating small graphics file sizes is essential to distributing images on the web. With smaller file sizes, web servers can store and transmit images more efficiently, and viewers can download images more quickly. You can view the size and the estimated download time for a web graphic in the Save For Web & Devices dialog box.

3. Choose the best file format for your graphic.

Different types of graphics need to be saved in different file formats to display their best and create a file size suitable for the web. For more information on specific formats, see Web graphics optimization options.

 *There are many Illustrator templates made specifically for the web, including web pages and banners. Choose File > New From Template to choose a template.*

More Help topics

[“Shift a color to a web-safe color”](#) on page 145

About pixel preview mode

To enable web designers to create pixel accurate designs, the pixel-aligned property has been added in Illustrator CS5. When the pixel-aligned property is enabled for an object, all the horizontal and vertical segments in the object get aligned to the pixel grid, which provides a crisp appearance to strokes. On any transformation, as long as this property is set for the object, it gets realigned to the pixel grid according to its new coordinates. You can enable this property by selecting the Align to Pixel Grid option from the Transform panel. Illustrator CS5 also provides the Align New Objects to Pixel Grid option at the document level, which is enabled by default for Web documents. With this property enabled, any new objects that you draw have the pixel-aligned property set by default.

For more information, see [“Drawing pixel-aligned paths for web workflows”](#) on page 58.

When you save artwork in a bitmap format, such as JPEG, GIF, or PNG, Illustrator rasterizes the artwork at 72 pixels per inch. You can preview how objects will appear when rasterized by choosing View > Pixel Preview. This is especially helpful when you want to control the precise placement, size, and anti-aliasing of objects in a rasterized graphic.

To understand how Illustrator divides objects into pixels, open a file that contains vector objects, choose View > Pixel Preview, and magnify the artwork so that you can see its individual pixels. The placement of pixels is determined by the pixel grid that divides the artboard into 1-point (1/72 inch) increments. You can view the pixel grid if you zoom in to 600% view. If you move, add, or transform an object, the object snaps to the pixel grid. As a result, any anti-aliasing along the “snapped” edges of the object (usually the left and top edges) disappears. Now deselect the View > Snap To Pixel command, and move the object. This time, you’ll be able to position the object between the grid lines. Notice how this affects the anti-aliasing of the object. As you can see, making very minor adjustments can affect how the object is rasterized.



Pixel Preview off (top) compared to on (bottom)

Important: The pixel grid is sensitive to the ruler origin (0,0). Moving the origin of the ruler will change how Illustrator rasterizes artwork.

More Help topics

[“Drawing pixel-aligned paths for web workflows”](#) on page 58

[“About bitmap images”](#) on page 271

Using Adobe Device Central with Illustrator

Device Central enables Illustrator users to preview how Illustrator files will look on a variety of mobile devices.

For example, a graphic artist may use Illustrator to design a wallpaper for mobile phones. After creating the file, the artist can easily test the file on a wide variety of phones. The artist can then make adjustments, such as altering the file so that it looks good on a number of phones, or creating two separate files that cover a range of popular phone screen sizes.

More Help topics

[Creating mobile content in Illustrator](#)

Access Illustrator from Adobe Device Central

- 1 Start Device Central.
- 2 Select File > New Document In > Illustrator.

In Device Central, the New Document panel appears with the correct options to create a new mobile document in the selected application.

- 3 Make any necessary changes, such as selecting a Player Version, Display Size, Flash Version, or Content type.
- 4 Do one of the following:
 - Select the Custom Size for All Selected Devices option and add a width and height (in pixels).
 - Select a device or multiple devices from the Device Sets list or Available Devices list.
- 5 If you selected multiple devices, Device Central selects a size for you. If you want to select a different size, click on a different device or set of devices.
- 6 Click Create.

The selected application opens with a new mobile document ready to edit.

Create mobile content with Adobe Device Central and Illustrator

- 1 In Illustrator, select File > New.
- 2 In New Document Profile, select Mobile and Devices.
- 3 Click Device Central to close the dialog box in Illustrator and open Device Central.
- 4 Select a content type.

The available Devices list on the left is updated and shows the devices that support the content type selected.

- 5 In Device Central, select a device, several devices, or a device set.

Based on the device(s) selected and content type, Device Central suggests one or multiple artboard sizes to be created. To create one document at a time, select a suggested document size (or select the Custom Size for all selected Devices option and enter custom values for Width and Height).

- 6 Click Create.

A blank AI file of the specified size opens in Illustrator. The new file has the following parameters set by default:

- Color Mode: RGB
- Raster Resolution: 72 ppi

- 7 Fill the blank AI file with content in Illustrator.
- 8 When you finish, select File > Save For Web & Devices.
- 9 In the Save for Web & Devices dialog box, select the desired format and change other export settings as desired.
- 10 Click Device Central.

A temporary file with the export settings specified is displayed in the Device Central Emulator tab. To continue testing, double-click the name of a different device in the Device Sets or Available Devices lists.

- 11 If, after previewing the file in Device Central, you need to make changes to the file, go back to Illustrator.
- 12 In the Illustrator Save for Web & Devices dialog box, make adjustments such as selecting a different format or quality for export.
- 13 To test the file again with the new export settings, click Device Central.
- 14 When you are satisfied with the results, click Save in the Illustrator Save for Web & Devices dialog box.

Note: To simply open Device Central from Illustrator (instead of creating and testing a file), select File > Device Central.

For a tutorial about creating content with Illustrator and Device Central, see <http://www.adobe.com/go/vid0207>.

Tips for creating Illustrator images for mobile devices

To optimize graphical content for mobile devices, save artwork created in Illustrator in any SVG format, including SVG-t, which is especially designed for mobile devices.

Use the following tips to ensure that images created in Illustrator display well on mobile devices:

- Use the SVG standard to create content. Using SVG to publish vector graphics on mobile devices results in a small file size, display independence, superior color control, zooming ability, and editable text (within the source code). Also, because SVG is XML-based, you can incorporate interactivity into images, such as highlighting, tool tips, special effects, audio, and animation.
- Work within the final dimensions of your target mobile device(s) from the beginning. Although SVG is scalable, working within the correct size will ensure that final graphics are optimized in quality and size for the target device(s).
- Set Illustrator color mode to RGB. SVG is viewed on RGB raster display devices, such as a monitors.
- To reduce file size, try reducing the number of objects (including groups) or making it less complex (fewer points). Using fewer points significantly reduces the amount of textual information needed to describe the artwork in the SVG file. To reduce points, select Object > Path > Simplify and try different combinations to find a balance between quality and number of points.
- Use symbols when possible. Symbols define the vectors that describe an object once, instead of multiple times. This is useful if artwork contains objects like button backgrounds that are reused.
- When animating graphics, limit the number of objects used and try to reuse objects whenever possible to reduce file size. Apply animations to groups of objects instead of to individual objects to avoid code repetition.
- Consider using SVGZ, the compressed gzipped version of SVG. Compression can reduce file size dramatically, depending on the content. Text can usually be heavily compressed, but binary-encoded content, such as embedded rasters (JPEG, PNG, or GIF files), cannot be compressed significantly. SVGZ files can be uncompressed by any application that expands files compressed with gzip. To use SVGZ successfully, check that your target mobile device can decompress gzip files.

For more tips and techniques for creating content for mobile phones and devices, see www.adobe.com/go/learn_cs_mobilewiki_en.

Slices and image maps

About slices

Web pages can contain many elements—HTML text, bitmap images, and vector graphics, to name a few. In Illustrator, you can use *slices* to define the boundaries of different web elements in your artwork. For example, if your artwork contains a bitmap image that needs to be optimized in JPEG format, while the rest of the image is better optimized as a GIF file, you can isolate the bitmap image using a slice. When you save the artwork as a web page using the Save For Web & Devices command, you can choose to save each slice as an independent file with its own format, settings, and color table.

Slices in an Illustrator document correspond to table cells in the resulting web page. By default, the slice area is exported as a image file that is enclosed in a table cell. If you want the table cell to contain HTML text and a background color instead of an image file, you can change the slice type to No Image. If you want to convert Illustrator text to HTML text, you can change the slice type to HTML Text.

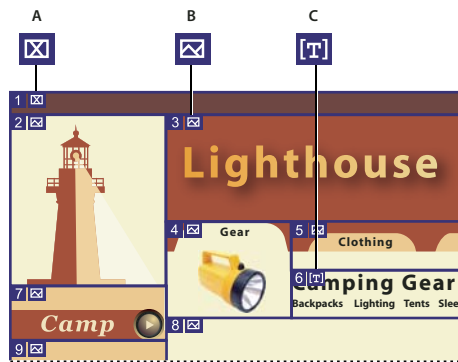



Sliced artwork using different slice types
 A. No Image slice B. Image slice C. HTML Text slice

You can view slices on the artboard and in the Save For Web & Devices dialog box. Illustrator numbers slices from left to right and top to bottom, beginning in the upper left corner of the artwork. If you change the arrangement or total number of slices, slice numbers are updated to reflect the new order.

When you create a slice, Illustrator slices the surrounding artwork into automatic slices to maintain the layout using a web-based table. There are two types of automatic slices: auto slices and subslices. *Auto slices* account for the areas of your artwork that you did not define as a slice. Illustrator regenerates auto slices every time you add or edit slices. *Subslices* indicate how overlapping user-defined slices will be divided. Although subslices are numbered and display a slice symbol, you cannot select them separately from the underlying slice. Illustrator regenerates subslices and auto slices as needed while you work.

Create slices

- ❖ Do one of the following:
 - Select one or more objects on the artboard, and choose Object > Slice > Make.
 - Select the Slice tool  and drag over the area where you want to create a slice. Shift-drag to constrain the slice to a square. Alt-drag (Windows) or Option-drag (Mac OS) to draw from the center.
 - Select one or more objects on the artboard, and choose Object > Slice > Create From Selection.
 - Place guides where you want to slice the artwork, and choose Object > Slice > Create From Guides.
 - Select an existing slice, and choose Object > Slice > Duplicate Slice.

 Use the Object > Slice > Make command when you want the slice dimensions to match the boundary of an element in your artwork. If you move or modify the element, the slice area automatically adjusts to encompass the new artwork. Also use this command to create a slice that captures text and basic formatting characteristics from a text object.

 Use the Slice tool, the Create From Selection command, or the Create From Guides command when you want the slice dimensions to be independent of the underlying artwork. Slices that you create in one of these ways appear as items in the Layers panel, and you can move, resize, and delete them in the same way as other vector objects.

Select slices

Use the Slice Select tool  to select a slice in the illustration window or the Save For Web & Devices dialog box.

- To select a slice, click it.
- To select multiple slices, Shift-click. (In the Save For Web & Devices dialog box, you can also Shift-drag.)
- To select an underlying slice when working with overlapping slices, click the visible section of it.

In addition, you can select slices in the illustration window by doing one of the following:

- To select a slice that was created using the Object > Slice > Make command, select the corresponding artwork on the artboard. If the slice is tied to a group or layer, select the target icon adjacent to the group or layer in the Layers panel.
- To select a slice that was created using the Slice tool, the Create From Selection command, or the Create From Guides command, target the slice in the Layers panel.
- Click on the slice path with the Selection tool .
- To select a slice path segment or slice anchor point, click on either item with the Direct Selection tool.

Note: You cannot select auto slices. These slices are dimmed.

Set slice options

A slice's options determine how the content of the slice will look and function in the resulting web page.

1 Do one of the following with the Slice Select tool:

- Select a slice in the illustration window, and choose Object > Slice > Slice Options.
- Double-click a slice in the Save For Web & Devices dialog box with the Slice Select tool.

2 Select a slice type and set the corresponding options:

Image Select this type if you want the slice area to be an image file in the resulting web page. If you want the image to be an HTML link, enter a URL and target frameset. You can also specify a message that will appear in the browser's status area when the mouse is positioned over the image, alternative text that will appear when the image is not visible, and a background color for the table cell.

No Image Select this type if you want the slice area to contain HTML text and a background color in the resulting web page. Enter the text you want in the Text Displayed In Cell text box and format the text using standard HTML tags. Be careful not to enter more text than can be displayed in the slice area. (If you enter too much text, it will extend into neighboring slices and affect the layout of your web page. However, because you cannot see the text on the artboard, this will not be apparent until you view the web page in a web browser.) Set the Horiz and Vert options to change the alignment of text in the table cell.

HTML Text This type is available only when you created the slice by selecting a text object and choosing Object > Slice > Make. The Illustrator text is converted to HTML text with basic formatting attributes in the resulting web page. To edit the text, update the text in your artwork. Set the Horiz and Vert options to change the alignment of text in the table cell. You can also select a background color for the table cell.

 *To edit the text for HTML Text slices in the Slice Options dialog box, change the slice type to No Image. This breaks the link with the text object on the artboard. To ignore text formatting, enter <unformatted> as the first word in the text object.*

Lock slices

Locking slices prevents you from making changes accidentally, such as resizing or moving.

- To lock all slices, choose View > Lock Slices.
- To lock individual slices, click the slices' edit column in the Layers panel.

More Help topics

[“Layers panel overview”](#) on page 220

Adjust slice boundaries

If you created a slice using the Object > Slice > Make command, the position and size of the slice is tied to the artwork it contains. Therefore, if you move or resize the artwork, the slice boundaries adjust automatically.

If you created a slice using the Slice tool, the Create From Selection command, or the Create From Guides command, you can manually adjust slices in the following ways:

- To move a slice, drag the slice to a new position with the Slice Selection tool . Press Shift to restrict movement to a vertical, horizontal, or 45° diagonal line.
- To resize a slice, select the slice with Slice Selection tool, and drag any corner or side of the slice. You can also use the Selection tool and Transform panel to resize slices.
- To align or distribute slices, use the Align panel. Aligning slices can eliminate unneeded auto slices to generate a smaller, more efficient HTML file.
- To change the stacking order of slices, drag the slice to a new position in the Layers panel or select an Object > Arrange command.
- To divide a slice, select the slice and choose Object > Slice > Divide Slices.

You can combine slices that were created by any method. Select the slices and choose Object > Slice > Combine Slices. The resulting slice takes its dimensions and position from the rectangle created by joining the outer edges of the combined slices. If the combined slices are not adjacent or are of different proportions or alignments, the new slice may overlap other slices.

To resize all slices to the artboard boundaries, choose Object > Slice > Clip To Artboard. Slices that extend beyond the artboard are truncated to fit the artboard and autoslices that lie within the artboard are extended to the artboard boundaries; all artwork remains the same.

Remove slices

You can remove slices by deleting them or by releasing them from the corresponding artwork.

- To delete a slice, select the slice, and press Delete. If the slice was created using the Object > Slice > Make command, the corresponding artwork is deleted at the same time. If you want to keep the corresponding artwork, release the slice instead of deleting it.
- To delete all slices, choose Object > Slice > Delete All. Slices created with the Object > Slice > Make command are released, not deleted.
- To release a slice, select the slice and choose Object > Slice > Release.

Show or hide slices

- To hide slices in the illustration window, choose View > Hide Slices.
- To hide slices in the Save For Web & Devices dialog box, click the Toggle Slices Visibility button .
- To hide slice numbers and change the color of slice lines, choose Edit > Preferences > Smart Guides & Slices (Windows) or Illustrator > Preferences > Smart Guides & Slices (Mac OS).

Create image maps

Image maps enable you to link one or more areas of an image—called hotspots—to a URL. When a user clicks on the hotspot, the web browser loads the linked file.

The main difference between using image maps and using slices to create links is in how the artwork is exported as a web page. Using image maps keeps the artwork intact as a single image file, while using slices causes the artwork to be divided into separate files. Another difference between image maps and slices is that image maps enable you to link polygonal or rectangular areas in your artwork, while slices enable you to link only rectangular areas. If you need to link only rectangular areas, using slices may be preferable to using an image map.

Note: *To avoid unexpected results, don't create image-map hotspots in slices that contain URL links—either the image map links or the slice links may be ignored in some browsers.*

- 1 Select the object that you want to link to a URL.
- 2 In the Attributes panel, select a shape for the image map from the Image Map menu.
- 3 Enter a relative or full URL in the URL text box, or select from the list of available URLs. You can verify the URL location by clicking the Browser button.

 *To increase the number of visible entries in the URL menu, select panel Options from the Attributes panel menu. Enter a value from 1 to 30 to define how many URL entries you want to be displayed in the URL list.*

SVG

About SVG

Bitmap image formats for the web—GIF, JPEG, WBMP, and PNG—describe images using a grid of pixels. The resulting files tend to be bulky, limited to a single (often low) resolution, and consume large amounts of bandwidth on the web. SVG, on the other hand, is a vector format that describes images as shapes, paths, text, and filter effects. The resulting files are compact and provide high-quality graphics on the web, in print, and even on resource-constrained, handheld devices. Users can magnify their view of an SVG image on-screen without sacrificing sharpness, detail, or clarity. In addition, SVG provides superior support for text and colors, which ensures that users will see images as they appear on your Illustrator artboard.

The SVG format is entirely XML-based and offers many advantages to developers and users alike. With SVG, you can use XML and JavaScript to create web graphics that respond to user actions with sophisticated effects such as highlighting, tool tips, audio, and animation.

You can save artwork in SVG format using the Save, Save As, Save A Copy, or Save For Web & Devices command. To access the complete set of SVG export options, use the Save, Save As, or Save A Copy command. The Save For Web & Devices command provides a subset of SVG export options which are applicable to web-oriented work.

For a video on creating mobile content in Illustrator, see www.adobe.com/go/vid0207.

How you set up your artwork in Illustrator will affect the resulting SVG file. Keep in mind the following guidelines:

- Use layers to add structure to an SVG file. When you save artwork in SVG format, each layer is converted to a group (<g>) element. (For example, a layer named Button1 becomes <g id="Button1_ver3.0"> in the SVG file.) Nested layers become SVG nested groups, and hidden layers are preserved with the display="none" SVG styling property.
- If you want objects on different layers to appear transparent, adjust the opacity of each object instead of each layer. If you alter opacity at the layer level, the resulting SVG file will not display transparency as it appears in Illustrator.
- Raster data is not scalable in the SVG Viewer and cannot be edited like other SVG elements. If possible, avoid creating artwork that will be rasterized in the SVG file. Gradient meshes and objects that use the Rasterize, Artistic, Blur, Brush Strokes, Distort, Pixelate, Sharpen, Sketch, Stylize, Texture, and Video effects are rasterized when saved in SVG format. Similarly, graphic styles that include these effects also produce rasterization. Use SVG effects to add graphic effects without causing rasterization.

- Use symbols and simplify the paths in your artwork to improve SVG performance. Also avoid using brushes that produce a lot of path data, such as the Charcoal, Fire Ash, and Scroll Pen, if performance is a high priority.
- Use slices, image maps, and scripts to add web links to an SVG file.
- A scripting language, such as JavaScript, opens unlimited functionality to an SVG file. Pointer and keyboard movements can invoke scripting functions such as rollover effects. Scripts can also use the document object model (DOM) to access and modify the SVG file—inserting or deleting SVG elements, for example.

More Help topics



[“Save in SVG format”](#) on page 280

Apply SVG effects

You can use SVG effects to add graphic properties such as drop shadows to your artwork. SVG effects differ from their bitmap counterparts in that they are XML-based and resolution-independent. In fact, an SVG effect is nothing more than a series of XML properties that describe various mathematical operations. The resulting effect is rendered to the target object instead of the source graphic.

Illustrator provides a default set of SVG effects. You can use the effects with their default properties, edit the XML code to produce custom effects, or write new SVG effects.

 *To modify Illustrator’s default SVG filters, use a text editor to edit the Adobe SVG Filters.svg file in the Documents and Settings/<userdir>/Application Data/Adobe/Adobe Illustrator CS5 Settings/<location> folder. You can modify existing filter definitions, delete filter definitions, and add new filter definitions.*

- 1 Select an object or group (or target a layer in the Layers panel).
- 2 Do one of the following:
 - To apply an effect with its default settings, select the effect from the bottom section of the Effect > SVG Filters submenu.
 - To apply an effect with custom settings, choose Effect > SVG Filters > Apply SVG Filter. In the dialog box, select the effect, and click the Edit SVG Filter button . Edit the default code and click OK.
 - To create and apply a new effect, choose Effect > SVG Filters > Apply SVG Filter. In the dialog box, click the New SVG Filter button , enter the new code, and click OK.

When you apply an SVG filter effect, Illustrator displays a rasterized version of the effect on the artboard. You can control the resolution of this preview image by modifying the document’s rasterization resolution setting.

Important: *An SVG effect must be the last effect when an object uses multiple effects; in other words, it must appear at the bottom of the Appearance panel (just above the Transparency entry). If other effects follow an SVG effect, the SVG output will consist of a raster object.*

More Help topics

[“About raster effects”](#) on page 368

[“Modify or delete an effect”](#) on page 370

Import effects from an SVG file

- 1 Choose Effect > SVG Filter > Import SVG Filter.
- 2 Select the SVG file you want to import effects from, and click Open.

SVG Interactivity panel overview

You use the SVG Interactivity panel (Window > SVG Interactivity) to add interactivity to your artwork when it is exported for viewing in a web browser. For example, by creating an event that triggers a JavaScript command, you can quickly create movement on a web page when the user performs an action such as moving a mouse cursor over an object. The SVG Interactivity panel also lets you see all the events and JavaScript files associated with the current file.

More Help topics

[“Save in SVG format”](#) on page 280

Delete an event from the SVG Interactivity panel

- To delete one event, select it and click the Delete button or choose Delete Event from the panel menu.
- To delete all events, choose Clear Events from the panel menu.

List, add, or remove events linked to a file

- 1 Click the Link JavaScript Files button .
- 2 In the JavaScript Files dialog box, select a JavaScript entry and do one of the following:
 - Click Add to browse for additional JavaScript files.
 - Click Remove to remove the selected JavaScript entry.

Add SVG interactivity to artwork

- 1 In the SVG Interactivity panel, select an event. (See [“SVG events”](#) on page 394.)
- 2 Enter the corresponding JavaScript, and press Enter.

SVG events

onfocus Triggers the action when the element receives focus, such as selection by the pointer.

onfocusout Triggers the action when the element loses focus (often when another element receives focus).

onactivate Triggers the action with a mouse click or keypress, depending upon the SVG element.

onmousedown Triggers the action when the mouse button is pressed down over an element.

onmouseup Triggers the action when the mouse button is released over an element.

onclick Triggers the action when the mouse is clicked over an element.

onmouseover Triggers the action when the pointer is moved onto an element.

onmousemove Triggers the action while the pointer is over an element.

onmouseout Triggers the action when the pointer is moved away from an element.

onkeydown Triggers the action when a key is pressed down.

onkeypress Triggers the action while a key is pressed down.

onkeyup Triggers the action when a key is released.

onload Triggers the action after the SVG document has been completely parsed by the browser. Use this event to call one-time-only initialization functions.

onerror Triggers the action when an element does not load properly or another error occurs.

onabort Triggers the action when the page loading is stopped before the element is completely loaded.

onunload Triggers the action when the SVG document is removed from a window or frame.

onzoom Triggers the action when the zoom level is changed for the document.

onresize Triggers the action when the document view is resized.

onscroll Triggers the action when the document view is scrolled or panned.

Creating animations

About Flash graphics

The Flash (SWF) file format is a vector-based graphics file format for scalable, compact graphics for the web. Because the file format is vector-based, the artwork maintains its image quality at any resolution and is ideal for the creation of animation frames. In Illustrator, you can create individual animation frames on layers and then export the image layers into individual frames for use on a website. You can also define *symbols* in an Illustrator file to reduce the size of an animation. When exported, each symbol is defined only once in the SWF file.

You can save artwork as a SWF file by using the Export command or the Save For Web & Devices command. Benefits of each include:

Export (SWF) command Provides the most control over animation and bitmap compression.

Save For Web & Devices command Provides more control over the mix of SWF and bitmap formats in a sliced layout. This command offers fewer Image options than the Export (SWF) command, but uses the Export command's last-used settings. (See SWF optimization options (Illustrator).)

Keep the following information in mind when preparing artwork to save as SWF:

- To keep the file size as small as possible when using symbols, apply effects to the symbol in the Symbols panel rather than to symbol instances in the artwork.
- Using the Symbol Stainer and Symbol Styler tools results in larger SWF files because Illustrator must create a copy of each symbol instance to maintain their appearances.
- Mesh objects and gradients with more than eight stops are rasterized and will appear as bitmap-filled shapes. Gradients with fewer than eight stops are exported as gradients.
- Patterns are rasterized into small images the size of the pattern art and tiled to fill the art.
- If a bitmap object extends beyond the boundaries of a slice, the entire object is included in the exported file.
- SWF supports rounded caps and joins only. Beveled or square caps and joins become rounded when exported to SWF.
- Pattern-filled text and pattern-filled strokes convert to paths and are filled with the pattern.
- Although text retains many of its features when exported to SWF, some information is lost. When importing a SWF file into Flash, leading, kerning, and tracking aren't maintained. Instead, text is broken into separate records to simulate the look of leading. When the SWF file is subsequently played in Flash Player, the appearance of the leading, kerning, and tracking in the file is maintained. If you wish to export text as paths, select Text As Outlines in the SWF Options dialog box, or convert the text to outlines before exporting to SWF by choosing the Create Outlines command.

For a video on using Illustrator and Flash together, see www.adobe.com/go/lrvid4099_xp. For a video on using symbols effectively between Illustrator and Flash, see www.adobe.com/go/vid0198. For a video on using text effectively between Illustrator and Flash, see www.adobe.com/go/vid0199.

More Help topics

“[Flash export options](#)” on page 285

“[About symbols](#)” on page 99

Create Flash animations

There are many ways to create Flash animations in Illustrator. One of the easiest is to place each animation frame on a separate Illustrator layer, and select the AI Layers To SWF Frames option when you export the artwork.

 For a video on exporting SWF files from Illustrator, see www.adobe.com/go/vid0214. For a video on creating mobile content in Illustrator, see www.adobe.com/go/vid0207. You can also go to Adobe Studio (<http://studio.adobe.com>) for tips and tutorials on creating Flash animations.

- 1 Create the artwork you want to animate. Use symbols to reduce the file size of the animation and simplify your work.
- 2 Create a separate layer for each frame in the animation.

You can do this by pasting the base artwork into a new layer and then editing the artwork. Or, you can use the Release To Layers command to automatically generate layers consisting of objects that build up cumulatively.

- 3 Make sure the layers are in the order in which you want to display them as animation frames.
- 4 Do one of the following:
 - Choose File > Export, choose Flash (SWF) for the format, and click Export. In the SWF Options dialog box, select AI Layers To SWF Frames for Export As. Set additional animation options, and click OK.
 - Choose File > Save For Web & Devices. Choose SWF from the Optimized File Format menu. From the Type Of Export menu, choose AI Layers To SWF Frames. Set additional options, and click Save.

More Help topics

“[About symbols](#)” on page 99

“[Release items to separate layers](#)” on page 223

“[Flash export options](#)” on page 285

Working with Illustrator and Flash

You can move Illustrator artwork into the Flash editing environment or directly into Flash Player. You can copy and paste artwork, save files in SWF format, or export artwork directly to Flash. In addition, Illustrator provides support for Flash dynamic text and movie clip symbols. For a video on using Flash and Illustrator together, see www.adobe.com/go/lrvid4099_xp.

You can also use Device Central to see how Illustrator artwork will appear in Flash Player on different handheld devices.

Pasting Illustrator artwork

You can create graphically rich artwork in Illustrator and copy and paste it into Flash simply, quickly, and seamlessly.

When you paste Illustrator artwork into Flash, the following attributes are preserved:

- Paths and shapes
- Scalability

- Stroke weights
- Gradient definitions
- Text (including OpenType fonts)
- Linked images
- Symbols
- Blending modes

In addition, Illustrator and Flash support pasted artwork in the following ways:

- When you select entire top-level layers in Illustrator artwork and paste them into Flash, the layers are preserved along with their properties (visibility and locking).
- Non-RGB Illustrator colors (CMYK, grayscale, and custom) convert to RGB in Flash. RGB colors paste as expected.
- When you import or paste Illustrator artwork, you can use various options to preserve effects (such as drop shadow on text) as Flash filters.
- Flash preserves Illustrator masks.

Exporting SWF files from Illustrator

From Illustrator, you can export SWF files that match the quality and compression of SWF files exported from Flash.

When you export, you can choose from a variety of presets to ensure optimal output, and you can specify how to handle multiple artboards, symbols, layers, text, and masks. For example, you can specify whether Illustrator symbols are exported as movie clips or graphics, or you can choose to create SWF symbols from Illustrator layers.

Importing Illustrator files into Flash

When you want to create complete layouts in Illustrator and then import them into Flash in one step, you can save your artwork in the native Illustrator format (AI) and import it, with high fidelity, into Flash using the File > Import To Stage or File > Import To Library commands in Flash.

If your Illustrator file contains multiple artboards, you select the artboard you want to import from the Import dialog box in Flash, and specify settings for each layer in that artboard. All objects on the selected artboard import as a single layer in Flash. If you import another artboard from that same AI file, the objects from that artboard import as a new layer in Flash.

When you import Illustrator artwork as an AI, EPS, or PDF file, Flash preserves the same attributes as for pasted Illustrator artwork. In addition, when an imported Illustrator file contains layers, you can import them in any of the following ways:

- Convert Illustrator layers to Flash layers
- Convert Illustrator layers to Flash frames
- Convert all Illustrator layers to a single Flash layer

Symbol workflow

Symbol workflow in Illustrator is similar to symbol workflow in Flash.

Symbol creation When you create a symbol in Illustrator, the Symbol Options dialog box lets you name the symbol and set options specific to Flash: movie clip symbol type (which is the default for Flash symbols), Flash registration grid location, and 9-slice scaling guides. In addition, you can use many of the same symbol keyboard shortcuts in Illustrator and Flash (such as F8 to create a symbol).

Isolation mode for symbol editing In Illustrator, double-click a symbol to open it in isolation mode for easier editing. In isolation mode, only the symbol instance is editable—all other objects on the artboard are dimmed and unavailable. After you exit isolation mode, the symbol in the Symbols panel, and all instances of that symbol are updated accordingly. In Flash, symbol-editing mode and the Library panel work in a similar fashion.

Symbol properties and links Using the Symbols panel or the Control panel, you can easily assign names to symbol instances, break links between instances and symbols, swap a symbol instance with another symbol, or create a copy of the symbol. In Flash, the editing features in the Library panel work in a similar way.

Static, dynamic, and input text objects

When you bring static text from Illustrator into Flash, Flash converts the text to outlines. In addition, you can set up your text in Illustrator as dynamic text. Dynamic text enables you to edit text content programmatically in Flash, and easily manage projects that require localization in multiple languages.

In Illustrator, you can specify individual text objects as static, dynamic, or input text. Dynamic text objects in Illustrator and Flash have similar properties. For example, both use kerning that affects all characters in a text block rather than individual characters, both anti-alias text the same way, and both can be linked to an external XML file containing text.

Chapter 12: Working with FXG

About FXG

When creating structured graphics in Illustrator for use in Adobe Flex®, you can save in the FXG format. FXG is a graphics file format based on a subset of MXML, the XML-based programming language used by the Flex framework. You can use FXG files in applications such as Adobe Flash Builder/Adobe Flash Catalyst to develop rich Internet applications and experiences. When saving as FXG, images must be under 16,777,216 total pixels and less than 8192 pixels in width or height.

For more information on using these formats, see the Adobe Flex website at www.adobe.com/products/flex.

You can directly import both Illustrator(.ai) and FXG (.fxg) documents in Flash Catalyst. To import specific Flash Catalyst content in Illustrator, use the Edit in Illustrator option available in Flash Catalyst. However, some of the objects or attributes are treated differently in Illustrator and Flash Catalyst. Using the FXG options, you can control the conversion of these objects and attributes. In addition to this option, you can also paste Illustrator content directly into Flash Catalyst.

When saving content in FXG format in Illustrator, any object or attribute that is not compatible with the FXG specifications is expanded, rasterized, outlined, or dropped based on the complexity of the content and the FXG mapping. For example, to preserve the artwork with 3D effect, which is not supported in FXG, the content is rasterized to save in FXG format.

For a list of object and attribute mapping between Illustrator and FXG, see “[FXG mapping of Illustrator objects and attributes](#)” on page 403.

For more information about the FXG file format, see www.adobe.com/go/learn_ai_fxg_spec_en.

Best practices for using FXG

Use the following guidelines while saving Illustrator files in FXG format and editing them in Flash Catalyst:

- Use Flash Catalyst or Basic RGB profile for creating content for FXG.
- Avoid using brushes as it may cause performance issues due to expanded paths.
- FXG provides mapping only for Drop Shadow, Inner/Outer Glow, and Blur, so prefer these effects over others.
- Avoid horizontal or vertical scaling of text to avoid outlining when saving to FXG.
- FXG does not support blends on filters. If you need to save FXG with filters editable or auto-save option, ensure that you set blend to Normal while applying filters (Drop Shadow, inner/outer glow) on any object for accurate appearance.
- In most cases, items created in Illustrator are rendered as pixel-snapped in Flash Catalyst to make horizontal or vertical stroke edges look sharp. To avoid content from shifting between Illustrator and Flash Catalyst, select the Align to Pixel Grid option while working in Illustrator. For more information about aligning objects to pixel grid, see “[Drawing pixel-aligned paths for web workflows](#)” on page 58.
- Objects with a blend mode other than normal that are blended against the default document background may display differently in Flash Catalyst. Objects with non-normal blend modes should always have another object behind them.

- Skewed items are not supported, and may be positioned differently when imported to Flash Catalyst.
- 9-slice scaling grids are not supported in Flash Catalyst.
- Reflected bitmaps and symbols are not supported in Flash Catalyst.
- Spot and process colors are not supported in Flash Catalyst.
- Vertical text is not supported in Flash Catalyst.
- Warning messages are displayed to guide you about specific data modifications to the selected object or attributes. However, in some cases the warning message may not be relevant for you. For example, a warning message such as "Some open type properties are dropped" when you deliberately set language to a value other than USA. These warning messages about content editability are displayed only if the Save Illustrator Private Data option is selected.

Save an Illustrator file in FXG format

To map Illustrator content in FXG while preserving maximum appearance and editability, you can save a document in FXG format. This document can then be opened in either Illustrator or Flash Catalyst.

- 1 Click either File > Save As or click File > Save A Copy.
- 2 Type a filename, and choose a location for the file.
- 3 Select Adobe FXG (*.FXG) as the file format, and click Save. The FXG Options dialog box is displayed.

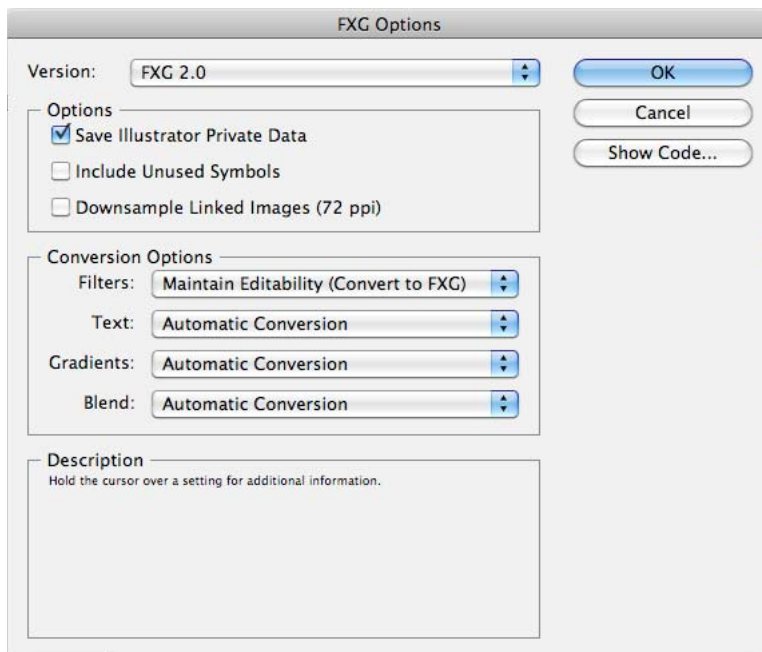

FXG Options Dialog Box

- 4 In the FXG Options dialog box, set the required options. The options available in this dialog box are:
Save Illustrator Private Data This option is selected by default. It enables better re-editability, when you import FXG files in Illustrator:

It allows maximum editability of FXG files, if you import these files in Illustrator.

Note: This option does not guarantee that all the content would be supported in the native Illustrator format. For example, brush strokes are not preserved because there is no support for retention of Illustrator private data for brush strokes. However, effects are preserved live on FXG import through Illustrator private data.

Include Unused Symbols Use this option to keep or discard unused symbols in the FXG file. Saving unused symbols in FXG may increase the file size.

Downsample Linked Images (72 ppi) Use this option for downsampling linked image files at 72 ppi, which is the standard web requirement.

Filters Drop Shadow, Inner Glow, Outer Glow, and Gaussian Blur are supported as filters in FXG. Illustrator provides a trade-off between appearance and editability for these filters, when exported. If you want to preserve editability of these filters with some loss of appearance, select Maintain Editability (Convert to FXG). If you prefer appearance over editability, select the other options: Preserve Appearance (Expand), Preserve Appearance (Rasterize).

Text To retain the appearance and maintain the editing capability, select the Automatic Conversion option. If editability cannot be maintained for the selected artwork, it is either expanded or rasterized to preserve appearance. To preserve visual appearance of text, select the Preserve Appearance (Rasterize) option or Preserve Appearance (Create Outline) to convert to Vector Outline for smaller file size. For maximum editability of text, select Maintain Editability (Convert to FXG). However, this option may result in loss of appearance.

Gradients Gradients are not fully compatible with FXG when the gradient has more than 16 stops. Gradient midpoints that are not equal to 50% are also mapped directly into FXG. Illustrator first tries to extrapolate those midpoints to actual stops and if they cannot be extrapolated, gradients are rasterized.

Illustrator has the capability to determine the priority when exporting gradients in FXG. If content editability is high priority, then select Maintain Editability (Convert to FXG). Select the Automatic Conversion option to preserve visual appearance and maintain the editing capability. Automatic conversion analyses and determines if content can be kept editable and still match the appearance. If keeping the content editable does not match the appearance then the art is rasterized.

Blend You can rasterize to preserve the appearance, by selecting Preserve Appearance (Rasterize) or select Automatic Conversion to allow Illustrator to automatically expand or rasterize the blending options based on the complexity of the blend.

Show Code Click this button to view the FXG code before generating the FXG file.

FXG is always saved with the Use Artboards option enabled. Artboards are imported as states in Flash Catalyst.

Note: The artboard range specified while saving FXG content decides the creation of pages or states for Flash Catalyst. If you save a document with multiple artboards in FXG format, any content that lies completely outside the artboard is not saved.

For overlapping artboards, any content that is shared across artboards is saved on each page, when saving in FXG format. Therefore, multiple pages with the same content are saved.

- 5 Click OK. If Illustrator makes any changes to save the content in FXG, the content changes are displayed in the FXG Save Warning dialog box.

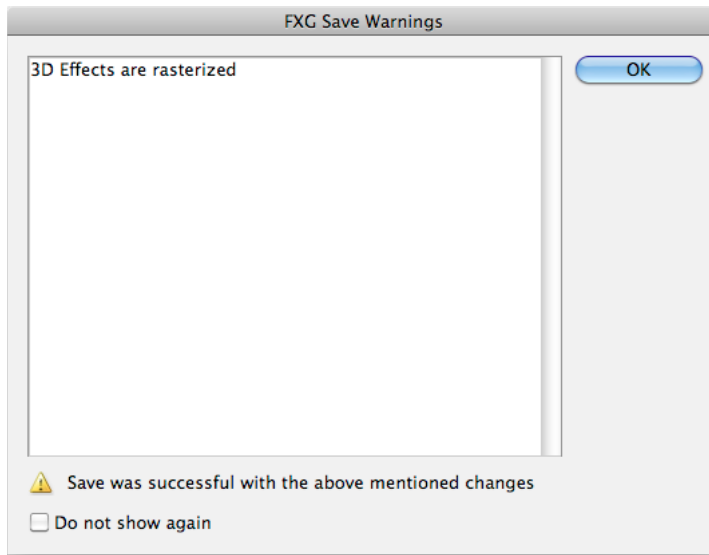

FXG Warning Dialog Box

Illustrator and Flash Catalyst workflow

To import or open an FXG file in Illustrator, click File > Open and select the .fxg file.

You can also open an FXG file in Illustrator by selecting the Edit in Illustrator option in Flash Catalyst. For more information, see Round-trip editing in Adobe Flash Catalyst documentation.

Note: You cannot link FXG content in Illustrator, you can only embed it.

Add or edit Flash Catalyst objects in Illustrator

To edit objects and attributes of an FXG file in Flash Catalyst, use the Edit in Illustrator option in Flash Catalyst. The selected objects are opened in Illustrator. After you finish editing in Illustrator, the object is reconverted to the FXG format, and passed back to Flash Catalyst.

You can edit an FXG file object in Illustrator, while working on the file in Flash Catalyst. To edit an object in Illustrator:

- 1 In Flash Catalyst, select the object that you want to edit in Illustrator
- 2 Do one of the following:
 - Right-click on the object, and then select the Edit in Adobe Illustrator CS5 option.
 - Choose Modify > Edit in Adobe Illustrator CS5.

Illustrator CS5 opens and the corresponding FXG file is automatically opened for editing. At the upper-left corner of the Illustrator window, the Done and Cancel options are available.

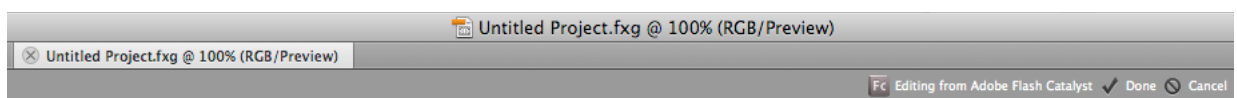

Done and cancel options for FXG file opened in Illustrator

Note: In Illustrator, only the selected objects are available for editing. All other objects are visible, but cannot be edited.

- 3 Change the selected object or create new objects.
- 4 Exit this mode by clicking the Done button at the upper-right corner in Illustrator.

When you click Done, the edited object and any new objects are reconverted into FXG format and passed back to Flash Catalyst.

If you click cancel, a dialog box is displayed to confirm that you do not want to save the changes made to the file.

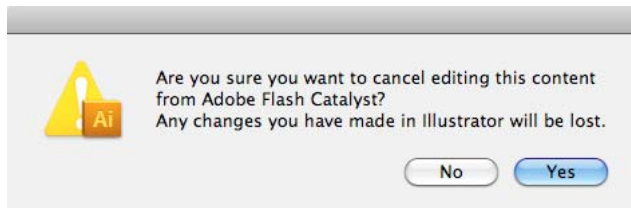

Dialog box to confirm cancellation of edit in Illustrator

- 5 In Flash Catalyst, set the required options in the FXG Options dialog box, and then click OK.

Import Illustrator content in Flash Catalyst

Flash Catalyst uses the FXG (.fxg) format files to create rich Internet applications and experiences. You can use content between Illustrator and Flash Catalyst in three ways:

- Import a .ai file directly in Flash Catalyst.
- Import a .fxg file in Flash Catalyst, which was saved as .fxg in Illustrator.
- Copy any object from Illustrator and paste it into a Flash Catalyst document.

For more information, see Round-trip editing in Adobe Flash Catalyst documentation.

When you copy and paste content into Flash Catalyst, certain objects and their attributes may not be compatible with the FXG specification. You can specify settings to manually control and preserve visual appearance, editability, or both.

To paste an Illustrator object in Flash Catalyst:

- 1 Select and copy the object from an open Adobe Illustrator CS5 file.
- 2 Paste the object in an open Flash Catalyst file.
- 3 In the Illustrator Import Options dialog box, specify the correct options as stated in step 4 of [“Save an Illustrator file in FXG format”](#) on page 400.

FXG mapping of Illustrator objects and attributes

Following is the list of objects and attributes that are directly mapped into FXG:

Illustrator object/attribute	Object/attribute sub-area	FXG tag	Export to FXG	Import FXG	Illustrator Private Data support	Behavior
Paths/Open	Move Segment	<Path>	Mapping Live	Mapping Live	No	
	Line Segment	<Path>	Mapping Live	Mapping Live	No	
	Cubic Bezier Segment	<Path>	Mapping Live	Mapping Live	No	
	Line	<Line>	Mapping Live	Mapping Live	No	
	Compound Paths	<Path>	Mapping Live	Mapping Live	No	
Shapes/Closed Paths	Ellipse	<Ellipse>	Mapping Live	Mapping Live	No	
	Rectangle/Rounded Rectangle	<Rect>	Mapping Live	Mapping Live	No	
	Star/Polygon	<Path>	Mapping Live	Mapping Live	No	
	Flare	<Path>	Expansion	Expansion	No	
	Compound Shape	<Group><Path>	Expansion	Expansion	Yes	
Fill	Solid Fill	<Fill><Solid Colors>	Mapping Live	Mapping Live	No	Colors are not preserved for Swatch libraries.
	Process/Spot Color/Registration/Global Process	<Fill><Solid Colors>	Convert to Solid	Convert to Solid	No	Colors are not preserved for Swatch libraries.
	Linear Gradient Fill	<Fill><LinearGradient>	Mapping Live	Mapping Live	Yes	You have the option to choose Gradient export in FXG by using the FXG save options.
	Radial Gradient Fill	<Fill><RadialGradient>	Mapping Live	Mapping Live	Yes	You have the option to choose Gradient export in FXG by using the FXG save options.
	Pattern Fill		Rasterized	Rasterized	No	
	Multiple Fills (Appearance panel)		Expansion	Expansion	Yes	
Stroke	Multiple Stroke (Appearance panel)		Expansion	Expansion	Yes	
	Pattern Stroke		Rasterization	Rasterization	No	
	Solid Color Stroke	<Stroke><SolidColorStroke>	Mapping Live	Mapping Live	No	Colors are not preserved for Swatch libraries.
	Stroke Depth		Mapping Live	Mapping Live	No	

Illustrator object/attribute	Object/attribute sub-area	FXG tag	Export to FXG	Import FXG	Illustrator Private Data support	Behavior
	Line Joins/Line Caps	<Stroke> <joints=""> <caps="">	Mapping Live	Mapping Live	No	
	Dashed Line/Dotted Line/Stroke Align		Expansion	Expansion	No	
Transparency						
	Opacity on Objects/Layer/Groups/Fills/Strokes	<alpha>	Mapping Live	Mapping Live	No	
Transparency panel Options	Transparency					
	Knockout		Rasterization	Rasterization	Yes	
	Isolate Blending		Rasterization	Rasterization	Yes	
Attribute panel Options	Attribute Panel					
	Overprint Fill/Overprint/Stroke/Image Maps/URL		Dropped	Dropped	No	
Layers and sublayers		<Group>	Mapping Live	Mapping Live	No	
	Hidden/Lock layers		Mapping Live	Mapping Live	No	
Group		<Group>	Mapping Live	Mapping Live	No	
	Blend Group		Expansion	Expansion	No	Blend is handled with FXG Save Options: Auto: automatically detects the complexity of blend based on steps, shapes, and rasterizes it if output is too complex otherwise expand. Rasterize: always rasterizes the blend output.
	Live Paint Group		Expansion	Expansion	No	
Symbols	<Graphic/Movie>	<Library> <Definitions>	Mapping Live	Mapping Live	No	
Placed Images (Embedded/Linked)	Linked/Embedded Images		Rasterization	Rasterization	Yes	Private data is written just to retain embedded art in Illustrator on round trip.
Raster Art			Rasterization	Rasterization	No	

Illustrator object/attribute	Object/attribute sub-area	FXG tag	Export to FXG	Import FXG	Illustrator Private Data support	Behavior
Opacity Mask		<maskType=luminosity>	Mapping Live	Mapping Live	Yes	
Effects	3D					
	Extrude & Bevel		Rasterization	Rasterization	Yes	Thumb rule for vector effect mapping in FXG is to expand the object with effect. However, 3D effect is rasterized because expanding objects with 3D effects generates numerous paths and causes performance issues in Flash Catalyst.
	Revolve		Rasterization	Rasterization	Rasterization	Thumb rule for vector effect mapping in FXG is to expand the object with effect. However, 3D effect is rasterized because expanding objects with 3D effects generates numerous paths and causes performance issues in Flash Catalyst.
	Rotate		Rasterization	Rasterization	Yes	Thumb rule for vector effect mapping in FXG is to expand the object with effect. However, 3D effect is rasterized because expanding objects with 3D effects generates numerous paths and causes performance issues in Flash Catalyst.
	Effects Converts to shape					
	Rectangle/Rounded Rectangle/Ellipse		Expansion	Expansion	Yes	
	Distort and Transform					
	Free Distort/ Pucker and Bloat/ Transform/ Twist/ Zigzag		Expansion	Expansion	Yes	
	Roughen/Tweak		Expansion	Expansion	No	
	Path					
	Offset Path/ Outline Object/ Outline Stroke		Expansion	Expansion	Yes	
	Pathfinder					
	Add/ Intersect/ Exclude/ Subtract/ Minus Back/ Divide/ trim/ Merge/ Crop/ Outline/ Hard Mix/ Soft Mix/ Trap		Expansion	Expansion	Yes	
	Rasterize		Rasterize	Rasterize	Yes	
	Stylize					

Illustrator object/attribute	Object/attribute sub-area	FXG tag	Export to FXG	Import FXG	Illustrator Private Data support	Behavior
	Add Arrowheads/Round Corners/Scribble		Expansion	Expansion	Yes	
	Drop Shadow	<filters> <DropShadowfilter>	Mapping Live	Mapping Live	Yes	When you save content as FXG, the "Mode" is always set to "Multiple" and "Darkness" is replaced by last used color in the Drop Shadow effect.
	Inner Glow	<filters> <GlowFilter inner="true">	Mapping Live	Mapping Live	Yes	When you save content as FXG, the "Mode" is always set to "Normal" and "Center" is converted to Edge.
	Outer Glow	<filters> <GlowFilter> or <filters> <GlowFilter inner="false">	Mapping Live	Mapping Live	Yes	When you save as FXG, "Mode" is set to "Normal".
	Warp					
	Arc/ Arc Lower/ Arc Upper/ Arch/ Bulge/ Shell Lower/ Shell Upper/ Flag/ Wave/ Fisheye/ Rise/ Fish/ Inflate/ Squeeze/ Twist		Expansion	Expansion	Yes	
	Blur					
	Gaussian Blur	<filters> <BlurFilter>	Mapping Live	Mapping Live	Yes	
	Smart/Radial Blur		Rasterization	Rasterization	Yes	
Graphs						
	Column/ Stacked Column/ Bar/ Stacked/ Line/ Area/ Scatter/ Pie/ Radar Graph		Rasterization	Rasterization	No	
Graphic Style			Expansion	Expansion	No	
Tracing Objects			Expansion	Expansion	No	
Image Maps			Dropped	Dropped	No	
Envelope Distort			Expansion	Expansion	No	
Foreign Art			Rasterization	Rasterization	No	

Illustrator object/attribute	Object/attribute sub-area	FXG tag	Export to FXG	Import FXG	Illustrator Private Data support	Behavior
Mesh Art			Rasterization	Rasterization	No	
Pattern			Rasterization	Rasterization	No	
Clipping Path and Clip Group		<Mask maskType="clip">	Mapping Live	Mapping Live	No	Masked objects with filled clipping path are rasterized on FXG save.
Gradient	Linear/Radial Gradient/Gradient Stops/Location/Angle		Mapping Live	Mapping Live	Yes	Gradient are handled with FXG Save Options: Auto: automatically detects whether gradient is mappable in FXG. If gradient is mappable, then gradient mapping is saved in FXG content otherwise the gradient object is rasterized. Maintain Editability [Convert To FXG]: This option preserves the editability of gradient in FXG preferred over appearance, regardless of the mapping being available.
Transformations on Image/Symbols/Gradients	Move/Scale		Mapping Live	Mapping Live	No	
<Through Transform Effect>	Rotate/Reflect/Scale		Expansion	Expansion	Yes	
Variables			Dropped	Dropped		
Flash Text			Dropped	Dropped		
SVG Interactivity			Dropped	Dropped		
Plug-in Art Adobe			Expansion	Expansion	No	
Plug-in Art Third Party			Expansion	Expansion	No	
Blend Mode	Darken/ Multiply/ Color Burn/ Lighten/ Screen/ Color Dodge/ Overlay/ Soft Light/ Hard Light/ Difference/ Exclusion/ Hue/ Saturation/ Color/ Luminosity		Mapping Live	Mapping Live	No	
Brushes						
	Calligraphic/ Scatter/ Art/ Pattern/ Bristle		Expansion	Expansion	No	

Illustrator object/attribute	Object/attribute sub-area	FXG tag	Export to FXG	Import FXG	Illustrator Private Data support	Behavior
Units	Points/Picas/Inches/ Millimeters/Centimeters		Convert to Pixels	Convert to Illustrator Units as per Preferences	No	
	Pixels		Mapping Live	Convert to Illustrator units as per Preferences	No	
Document Profiles			Convert to RGB profile	Convert to RGB profile	No	
Document Orientation	Portrait (Vertical) / Landscape (Horizontal)		Dropped	Dropped	Yes	
Perspective Grid			Dropped	Dropped	No	
Embed Color Profile			Dropped	Dropped	No	
Photoshop Effects	Artistic					
	Color Pencil/ Cutout/ Dry Brush/ Film Grain/ Fresco/ Neon Glow/ Paint Daubs/ Panel Knife/ Plastic Wrap/ Poster Edges/ Rough Pastels/ Smudge Stick/ Sponge/ Underpainting/ Watercolor		Rasterization	Rasterization	Yes	
	Blur					
	Gaussian Blur		Mapping Live	Mapping Live	Yes	
	Radial/Smart Blur		Rasterization	Rasterization	Yes	
	Brush Strokes					
	Accented Edges/ Angled Strokes/ Crosshatch/ Dark Strokes/ Ink Outlines/ Spatter/ Sprayed Strokes/ Sumi-e		Rasterization	Rasterization	Yes	
	Distort					
	Diffuse Glow/ Glass/ Ocean Ripple		Rasterization	Rasterization	Yes	
	Pixelate					
	Color Halftone/ Crystallize/ Mezzotint/ Pointillize		Rasterization	Rasterization	Yes	

Illustrator object/attribute	Object/attribute sub-area	FXG tag	Export to FXG	Import FXG	Illustrator Private Data support	Behavior
	Sharpen					
	Unsharp Mask		Rasterization	Rasterization	Yes	
	Sketch					
	Bas Relief/ Chalk & Charcoal/ Charcoal/ Chrome/ Content Crayon/ Graphic Pen/ Halftone Pattern/ Note Paper/ Photocopy/ Plaster/ Reticulation/ Stamp/ Torn Edges/ Water Paper		Rasterization	Rasterization	Yes	
	Stylize					
	Glowing Edges		Rasterization	Rasterization	Yes	
	Texture					
	Craquelure/ grain/ Mosaic Tiles/ Patchwork/ Stained Glass/ Texturizer		Rasterization	Rasterization	Yes	
	Video					
	De-Interlace / NTSC Colors		Rasterization	Rasterization	Yes	
Slices			Dropped	Dropped	No	
Guides			Dropped	Dropped	No	
Symbol Set		<Group><Symbol>	Expansion	Expansion	No	
XMP			Dropped	Dropped	No	
Multiple Artboards	Single Artboard	<d:layerType=Page>	Mapping Live	Mapping Live	No	Objects outside artboards are always discarded.

- Size of the Main Graphic is:
 - Width: Artboard with maximum width
 - Height: Artboard with maximum height
- Use Artboards options for FXG, generates a single FXG file with only pages corresponding to respective artboards:
 - Illustrator does not generate an FXG file for each artboard.
 - If you select all artboards then a single FXG file having all the artboards is generated.
 - If you select a range such as 1, 3, 5, then only a single FXG file containing page corresponding to artboard 1, 3 and 5 are generated.

Following text attributes are compatible with FXG:

Attribute Type	Illustrator Attribute	FXG Tag	Map/Outline/Drop/Conversion/Partial
Character Attributes			
	font Name	fontFamily	Preserved
	font Size	fontSize	Preserved
	leading	lineHeight	Preserved
	underline	textDecoration	Preserved
	strikethrough	lineThrough	Preserved
	tracking	trackingRight	Preserved
	fill color	color	Preserved
	transparency	textAlpha	Preserved
	kerning		Dropped
	baseline shift	baselineShift	Preserved
	Japanese properties (Aki, Tsume, Warichu, Tate-Chu -Yoko)		Text is outlined for CJK languages (for non-default values) and is dropped for others.
Paragraph Properties			
	Alignment	textAlign	Preserved
	Justify with last line aligned (left, center, right, or all)	textAlignLast	Preserved
	First line left indent	textIndent	Preserved
	Left Indent	paragraphstartindent	Preserved
	Right Indent	paragraphendindent	Preserved
	spaceBefore	paragraphspacebefore	Preserve
	spaceAfter	paragraphspaceafter	Preserve
	Horizontal/Vertical text frame	blockProgression	Preserved
Rich Text Attributes			
	width	width	
	height	height	
	x	x	
	y	y	
	Indent Spacing	paddingLeft	
	Indent Spacing	paddingRight	
	Indent Spacing	paddingTop	
	Indent Spacing	paddingBottom	

Attribute Type	Illustrator Attribute	FXG Tag	Map/Outline/Drop/Conversion/Partial
	Legacy Text		Expanded
	Text on Path		Expanded
	Text objects with unsupported Area type options		Unsupported Area type options are dropped
	Text objects with wraps		Expanded in Auto mode
	Text objects with non-rectangular shape		
Other features			
	Character attributes other than the ones mentioned in the table previously		Dropped
	Paragraph Attributes other than the ones mentioned previously		Dropped
	Character styles		Dropped (Appearance will be preserved)
	Paragraph styles		Dropped (Appearance will be preserved)
	Tab settings	tabStops	Preserved
	Open Type features		Preserved (partially)
	Composite fonts		Replaced by the default font of the script.
	Text Frame Fill		The object is expanded

Following is a list of attributes that are not supported by Illustrator but are supported by FXG:

Attribute Name	FXG tag	Illustrator Import: level of support	Behavior
LinearGradientstroke	<Stroke><LinearGradientstroke>	Preserved till not tampered	Illustrator preserves FXG data for this attribute until tampered. If any editing in Illustrator affects this attribute directly, then Illustrator overwrites the data causing drop of this attribute.
RadialGradientstroke	<Stroke><RadialGradientstroke>	Preserved till not tampered	Illustrator preserves FXG data for this attribute until tampered. If any editing in Illustrator affects this attribute directly, then Illustrator overwrites the data causing drop of this attribute.
ColorTransform		Preserved till not tampered	Illustrator preserves FXG data for this attribute until tampered. If any editing in Illustrator affects this attribute directly, then Illustrator overwrites the data causing drop of this attribute.
Blend Modes:			
Add/ alpha/ erase/ invert/ subtract		Preserved till not tampered	Illustrator preserves FXG data for this attribute until tampered. If any editing in Illustrator affects this attribute directly, then Illustrator overwrites the data causing drop of this attribute.
9 Slicing Attributes on Groups		Preserved till not tampered	Illustrator preserves FXG data for this attribute until tampered. If any editing in Illustrator affects this attribute directly, then Illustrator overwrites the data causing drop of this attribute.

Attribute Name	FXG tag	Illustrator Import: level of support	Behavior
Effects:			
GradientBevel / Bevel/ GradientGlow/		Preserved till not tampered	Illustrator preserves FXG data for this attribute until tampered. If any editing in Illustrator affects this attribute directly, then Illustrator overwrites the data causing drop of this attribute.
ColorMatrix/ Displacement Map/ Convolution/ AdjustColor Filters		Preserved till not tampered	Illustrator preserves FXG data for this attribute until tampered. If any editing in Illustrator affects this attribute directly, then Illustrator overwrites the data causing drop of this attribute.

Chapter 13: Printing

Setting up documents for printing

To make optimum decisions about printing, you should understand basic printing principles, including how the resolution of your printer or the calibration and resolution of your monitor can affect the way your artwork appears when printed. Illustrator's Print dialog box is designed to help you through the printing workflow. Each set of options in the dialog box is organized to guide you through the printing process.

Print a composite of artwork

A composite is a single-page version of artwork that corresponds to what you see in the illustration window—in other words, a straightforward print job. Composites are also useful for proofing the overall page design, verifying image resolution, and identifying problems that may occur on an imagesetter (such as PostScript errors).

- 1 Choose File > Print.
- 2 Select a printer from the Printer menu. To print to a file instead of a printer, select Adobe PostScript® File or Adobe PDF.
- 3 Choose one of the following artboard options:
 - To print everything on one page, select Ignore Artboards.
 - To print each artboard separately, deselect Ignore Artboards and specify if you want to print all artboards (All), or a specific range, such as 1-3.
- 4 Select Output on the left side of the Print dialog box, and make sure that Mode is set to Composite.
- 5 Set additional printing options.
- 6 Click Print.

 *If your document uses layers, you can specify which ones to print. Choose File > Print, and select an option from the Print Layers menu: Visible And Printable Layers, Visible Layers, or All Layers. For a video on creating crop areas for print, see www.adobe.com/go/vid0213.*

More Help topics

- “[Print dialog box options](#)” on page 415
- “[Using multiple artboards](#)” on page 31
- “[Printing gradients, meshes, and color blends](#)” on page 428
- “[Printing long, complex paths](#)” on page 425
- “[Printing and saving transparent artwork](#)” on page 431

Make artwork nonprintable

The Layers panel makes it easy to print different versions of your artwork. For example, you can choose to print only the type objects in a document in order to proof your text. You can also add nonprinting elements to artwork to record important information.

- To prevent artwork from displaying in the document window, printing, and exporting, hide the corresponding items in the Layers panel.

- To prevent artwork from printing, but not from showing on the artboard or exporting, double-click a layer name in the Layers panel. In the Layer Options dialog box, deselect the Print option, and click OK. The layer name changes to italics in the Layers panel.
- To create artwork that does not print or export, even when visible on the artboard, select Template in the Layer Options dialog box.

Note: You can also specify multiple artboards in your document and then choose one artboard at a time for printing in the Print dialog box. Only artwork within the artboard prints. For a video on defining crop artboards, see www.adobe.com/go/lrvid4016_ai.

More Help topics

[“Layers panel overview”](#) on page 220

[“Using multiple artboards”](#) on page 31

Print dialog box options

Each category of options in the Print dialog box—from General options to Summary options—is organized to guide you through the process of printing your document. To display a set of options, select the set name on the left side of the dialog box. Many of these options are preset by the startup profile you chose when you started your document.

General Set the page size and orientation, specify how many pages to print, scale the artwork, specify tiling options and choose which layers to print.

Marks & Bleed Select printer’s marks and create a bleed.

Output Create color separations.

Graphics Set printing options for paths, fonts, PostScript files, gradients, meshes, and blends.

Color Management Select a color profile and rendering intent for printing.

Advanced Control the flattening (or possible rasterization) of vector artwork during printing.

Summary View and save a summary of print settings.

More Help topics

[“Create new documents”](#) on page 26

Reposition artwork on the page

The preview image in the Print dialog box shows you where artwork will be printed on the page.

1 Choose File > Print.

2 Do one of the following:

- Drag the artwork in the preview image at the lower left corner of the dialog box.
- Click a square or arrow on the Placement icon to specify the origin point for aligning the artwork in relation to the page. Enter values for Origin X and Origin Y to fine-tune the position of the artwork.

 *To move the printable area directly on the artboard, drag in the illustration window with the Print Tiling tool. As you drag, the Print Tiling tool responds as if you were moving the printable area from its lower left corner. You can move the printable area anywhere on the artboard; however, any part of a page that extends past the printable area boundary is not printed.*

More Help topics

[“Layers panel overview”](#) on page 220

[“Using multiple artboards”](#) on page 31

Print multiple artboards

When you create a document with multiple artboards, you can print the document in a variety of ways. You can ignore the artboards and print everything on one page (tiling may be required if your artboards expand the page boundaries). Or you can print each artboard as an individual page. When you print artboards as individual pages, you can choose to print all artboards, or a range of artboards.

- 1 Choose File > Print.
- 2 Do one of the following:
 - To print all artboards as separate pages, select All. You can see all the pages listed in the preview area in the lower left corner of the Print dialog box.
 - To print a subset of artboards as separate pages, select Range, and specify the artboards to print.
 - To print the artwork on all the artboards together on a single page, select Ignore Artboards. If the artwork extends past the boundaries of the page, you can scale or tile it.
- 3 Specify other print options as desired, and click Print.

Automatically rotate artboards for printing

In Illustrator CS5, all the artboards in a document can automatically rotate to print to the chosen media size. Select the Auto-Rotate check box in the Print dialog box to set auto rotation for Illustrator documents. For a document created in CS5, Auto-Rotate is enabled by default.

For example, consider a document with both landscape (width is more than height) and portrait (height is more than width) media size. If you select the media size as portrait in the Print dialog box, then the landscape artboards automatically rotate to portrait media when printing.

Note: When Auto-Rotate is selected, you cannot change the page orientation.

Tile artwork on multiple pages

If you are printing artwork from a single artboard (or ignored artboards) that cannot fit on a single page, you can *tile* the artwork onto multiple pages. If your document has multiple art

- 1 Choose File > Print.
- 2 Select Tile option:

Note: If your document has multiple artboards, first select Ignore Artboards, or specify 1 page in the Range option and select Fit To Page.

Full Pages Divides the artboard into full media-sized pages for output.

Imageable Areas Divides the artboard into pages based on what the selected device can image. This option is useful for outputting artwork that is larger than your device can handle, because it allows you to reassemble tiled pieces into the original larger artwork.

- 3 (Optional) If you selected Full Pages, set the Overlap option to specify the amount of overlap between pages.

More Help topics

[“About print tiling”](#) on page 38

Change the page size and orientation

Adobe Illustrator normally uses the default page size defined by the PPD file for the selected printer. However, you can change the media size to any of the sizes listed in the PPD file as well as specify portrait (vertical) or landscape (horizontal) orientation. The largest page size you can specify depends on the maximum imageable area of your imagesetter.

Important: *Changing page size and orientation in the Print dialog box is for printing purposes only. To change the page size or orientation of your artboard, use the Artboard Options dialog box or the Artboard options in the Control panel. (See [“Edit artboards”](#) on page 35.)*

Note the following when specifying the page size and orientation:

- If you select a different media size (for example, if you change from US Letter to US Legal), the artwork is repositioned in the preview window. This is because the preview window displays the entire imageable area of the selected media; when the media size is changed, the preview window automatically rescales to include the imageable area.

Note: *The imageable area may vary by PPD file, even for the same media size (for example, US Letter), because different printers and imagesetters define the sizes of their imageable areas differently.*

- The default placement of the page on the film or paper depends on the imagesetter used to print the page.
- Make sure that your media size is large enough to contain your artwork as well as trim marks, registration marks, and other necessary printing information. To conserve imagesetter film or paper, however, select the smallest page size that accommodates your artwork and necessary printing information.
- If your imagesetter can accommodate the longest side of your imageable area, you can conserve a considerable amount of film or paper by using Transverse or changing the orientation of the printed artwork. Consult the documentation on your specific printer for more information.

1 Choose File > Print.

2 Select a page size from the Size menu. The available sizes are determined by the current printer and PPD file. If the PPD file for the printer allows it, you can select Custom to specify a custom page size in the Width and Height text boxes.

3 Click an Orientation button to set the page direction:

Portrait Up  Prints in portrait orientation, right side up.

Landscape Left  Prints in landscape orientation, rotated to the left.

Portrait Down  Prints in portrait orientation, upside down.

Landscape Right  Prints in landscape orientation, rotated to the right.

4 (Optional) Select Transverse to rotate the printed artwork 90°. To use this option, you must use a PPD that supports transverse printing and custom page sizes.

More Help topics

[“About PPD files”](#) on page 424

[“Edit artboards”](#) on page 35

Scale a document for printing

To fit an oversized document on a piece of paper smaller than the artwork's actual dimensions, you can use the Print dialog box to scale the document's width and height, either symmetrically or asymmetrically. Asymmetric scaling is useful when, for example, you're printing film for use on a flexographic press: if you know in which direction the plate will be mounted on the press drum, scaling can compensate for the 2% to 3% stretching of the plate that usually occurs. Scaling does not affect the size of the pages in the document, it just changes the scale at which the document prints.

- 1 Choose File > Print.
- 2 Do one of the following:
 - To prevent scaling, select Do Not Scale.
 - To scale the document automatically to fit to the page, select Fit To Page. The scaling percentage is determined by the imageable area defined by the selected PPD.
 - To activate the Width and Height text boxes, select Custom. Enter percentages from 1 to 1000 for the width or height. Deselect the Constrain Proportions button  to change the document width-to-height ratio.

Change the printer resolution and screen frequency

Adobe Illustrator prints fastest and best by using the default printer resolution and screen frequency. However, in some cases, you might want to change the printer resolution and screen frequency—for example, if you draw a very long curved path that won't print due to a limit-check error, if printing is slow, or if gradients and meshes show banding when printed.

- 1 Choose File > Print.
- 2 For Printer, select a PostScript printer, Adobe PostScript® File, or Adobe PDF.
- 3 Select Output on the left side of the Print dialog box.
- 4 For Printer Resolution, select a screen frequency (lpi) and printer resolution (dpi) combination.

Printer resolution is measured in the number of ink dots produced per inch (dpi). Most desktop laser printers have a resolution of 600 dpi, and imagesetters have a resolution of 1200 dpi or higher. Inkjet printers produce a microscopic spray of ink, not actual dots; however, most inkjet printers have an approximate resolution of 300 to 720 dpi.

When printing to a desktop laser printer, but especially to imagesetters, you must also consider screen frequency. Screen frequency is the number of halftone cells per inch used to print grayscale images or color separations. Also known as screen ruling or line screen, screen frequency is measured in lines per inch (lpi)—or lines of cells per inch in a halftone screen.

A high line-screen ruling (for example, 150 lpi) spaces the dots used to create an image close together to create a finely rendered image on the press; a low screen ruling (60 lpi to 85 lpi) spaces the dots farther apart to create a coarser image. The size of the dots is also determined by the line screen. A high line-screen ruling uses small dots; a low screen ruling uses large dots. The most important factor in choosing a line-screen ruling is the type of printing press your job uses. Ask your print shop how fine a line screen its press can hold, and make your choices accordingly.

The PPD files for high-resolution imagesetters offer a wide range of possible line-screen rulings paired with various imagesetter resolutions. The PPD files for lower-resolution printers typically have only a few choices for line screens, and they are coarser screens of between 53 lpi and 85 lpi. The coarser screens, however, give optimum results on lower-resolution printers. Using a finer screen of 100 lpi, for example, actually decreases the quality of your image when a low-resolution printer is used for final output. That's because increasing the lpi for a given resolution decreases the number of colors that can be reproduced.

Note: Some imagesetters and desktop laser printers use screening technologies other than halftoning. If you are printing an image on a nonhalftone printer, consult your service provider or your printer documentation for the recommended resolutions.

Printing color separations

About color separations

To reproduce color and continuous-tone images, printers usually separate artwork into four plates (called *process colors*)—one plate for each of the cyan, magenta, yellow, and black portions of the image. You can also include custom inks (called *spot colors*). In this case, a separate plate is created for each spot color. When inked with the appropriate color and printed in register with one another, these colors combine to reproduce the original artwork.

The process of dividing the image into two or more colors is called *color separating*, and the film from which the plates are created are called the *separations*.

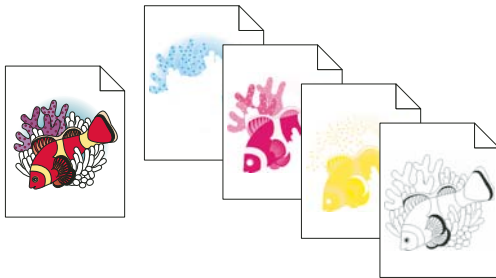

Composite image printed on a color laser printer compared to four-color separations printed on an imagesetter.

 To produce high-quality separations, you should work closely with the print shop that will produce your separations, consulting its experts before beginning each job and during the process. To see a video on using the Separations Preview panel, see www.adobe.com/go/lrvid4021_ai.

More Help topics

“[About process colors](#)” on page 117

“[About spot colors](#)” on page 117

Preparing artwork for color separating

Before you print color separations from Illustrator, it’s a good idea to perform the following prepress tasks:

- Set up color management, including calibrating your monitor and selecting an Illustrator Color Setting.
- Soft-proof how color will appear on the intended output device. Choose Window > Separations Preview to preview how the color separations will look.
- If the document is in RGB mode, choose File > Document Color Mode > CMYK Color to convert it to CMYK Mode.
- If your artwork contains color blends, optimize them so that they print smoothly (without discrete bands of color).
- If your artwork requires trapping, set up appropriate overprinting and trapping.
- If your artwork contains areas of transparent, overlapping colors, preview which areas will be affected by flattening and note which flattening options you want to use.

 Use the Live Color dialog box to globally convert and reduce colors. For example, if you want to convert a process color document to a 2-color spot document use the Assign portion of Live Color, and specify which colors you want and how they are assigned to existing colors.

More Help topics

“Printing and saving transparent artwork” on page 431

“Reduce colors in your artwork” on page 142

“Create a trap” on page 440

“Set up overprinting” on page 439

Preview color separations



You can preview color separations and overprinting using the Separations Preview panel. To see a video on using the Separations Preview panel, see www.adobe.com/go/lrvid4021_ai.

Previewing separations on your monitor lets you preview spot color objects in your document, and check the following:

Rich black Previewing separations lets you identify areas that will print as rich black, or process black (K) ink mixed with color inks for increased opacity and richer color.

Overprinting You can preview how blending, transparency, and overprinting will appear in color-separated output. You can also see overprinting effects when you output to a composite printing device.

Note: *The Separation Preview panel in Illustrator is slightly different from the Separation Preview panels in InDesign and Acrobat, for instance, the Preview panel in Illustrator is for CMYK document mode only.*



- 1 Choose Window > Separations Preview.
- 2 Select Overprint Preview.
- 3 Do any of the following:
 - To hide a separation ink on screen, click the eye icon  to the left of the separation name. Click again to view the separation.
 - To hide all separation inks on screen except one, Alt-click (Windows) or Option-click (Mac OS) the eye icon for that separation. Alt-click (Windows) or Option-click (Mac OS) the eye icon again to view all separations again.
 - To view all process plates at once, click the CMYK icon .
- 4 To return to normal view, deselect Overprint Preview.

While previewing separations on your monitor can help you detect problems without the expense of printing separations, it does not let you preview trapping, emulsion options, printer’s marks, and halftone screens and resolution. Work with your commercial printer to verify these settings using integral or overlay proofs. Setting inks to be visible or hidden on screen in the Separations Preview panel does not affect the actual separations process—it only affects how they appear on your screen during the preview.

Note: *Objects on hidden layers are not included in an on-screen preview.*

Print color separations

- 1 Choose File > Print.
- 2 Select a printer and PPD file. To print to a file instead of a printer, select Adobe PostScript® File or Adobe PDF.

- 3 Select Output on the left side of the Print dialog box.
- 4 For Mode, select either Separations (Host-Based) or In-RIP Separations.
- 5 Specify an emulsion, image exposure, and printer resolution for the separations.
- 6 Set options for the color plates you want to separate:
 - To disable printing of a color plate, click the printer icon  next to the color in the Document Ink Options list. Click again to restore printing for the color.
 - To convert all spot colors to process colors, so that they are printed as part of the process-color plates rather than on a separate plate, select Convert All Spot Colors To Process.
 - To convert an individual spot color to process colors, click the spot color icon  next to the color in the Document Ink Options list. A four-color process icon  appears. Click again to revert the color back to a spot color.
 - To overprint all black ink, select Overprint Black.
 - To change the screen frequency, screen angle, and shape of halftone dots for a plate, double-click the ink name. Alternatively, click the existing setting in the Document Ink Options list, and make the desired changes. Note however, that the default angles and frequencies are determined by the selected PPD file. Check with your print shop for the preferred frequency and angle before creating your own halftone screens.

 *If your art contains more than one spot color, particularly interactions between two or more spot colors, assign different screen angles to each spot color.*

- 7 Set additional options in the Print dialog box.

In particular, you can specify how to position, scale, and crop the artwork; set up printer's marks and a bleed; and choose flattening settings for transparent artwork.

- 8 Click Print.

Note: To see a video on using the Separations Preview panel, see www.adobe.com/go/lrvid4021_ai.

More Help topics

[“Change the printer resolution and screen frequency”](#) on page 418

[“Print an object on all plates”](#) on page 422

[“Print dialog box options”](#) on page 415

Color separation modes

Illustrator supports two common PostScript workflows, or modes, for creating color separations. The main difference between the two is where separations are created—at the *host computer* (the system using Illustrator and the printer driver), or at the output device's RIP (raster image processor).

In the traditional host-based, pre-separated workflow, Illustrator creates PostScript data for each of the separations required for the document, and sends that information to the output device.

In the newer RIP-based workflow, a new generation of PostScript RIPs perform color separations, trapping, and even color management at the RIP, leaving the host computer free to perform other tasks. This approach takes less time for Illustrator to generate the file, and minimizes the amount of data transmitted for any given print job. For example, instead of sending PostScript information for four or more pages to print host-based color separations, Illustrator sends the PostScript information for a single composite PostScript file for processing in the RIP.

Emulsion and image exposure

Emulsion refers to the photosensitive layer on a piece of film or paper. *Up (Right Reading)* means that type in the image is readable (that is, “right reading”) when the photosensitive layer is facing you. *Down (Right Reading)* means that type is readable when the photosensitive layer is facing away from you. Normally, images printed on paper are printed Up (Right Reading), whereas images printed on film are usually printed Down (Right Reading). Check with your print shop to determine which emulsion direction it prefers.

To tell whether you are looking at the emulsion side or the nonemulsion side (also referred to as the *base*), examine the final film under bright light. One side appears shinier than the other. The dull side is the emulsion side; the shiny side is the base.

Image exposure refers to whether artwork prints as a positive or negative image. Typically, print shops require negative film in the United States and positive film in Europe and Japan. If you are unsure about which image type to use, consult your print shop.

Print an object on all plates

If you want to print an object on all plates in the printing process, including spot-color plates, you can convert it to a *registration color*. Registration marks, trim marks, and page information are automatically assigned registration colors.

- 1 Select the object.
- 2 In the Swatches panel, click the Registration color swatch , located in the first row of swatches, by default.

 *To change the on-screen appearance of the registration color from the default black, use the Color panel. The color you specify will be used for representing registration-colored objects on the screen. These objects will always print as gray on composites and as an equal tint of all inks in separations.*

Printer's marks and bleed

About printer's marks

When you prepare artwork for printing, a number of marks are needed for the printer device to register the artwork elements precisely and verify correct color. You can add the following kinds of printer's marks to your artwork:

Trim Marks Fine (hairline) horizontal and vertical rules that define where the page should be trimmed. Trim marks can also help register (align) one color separation to another.

Registration Marks Small targets outside the page area for aligning the different separations in a color document.

Color Bars Small squares of color representing the CMYK inks and tints of gray (in 10% increments). Your service provider uses these marks to adjust ink density on the printing press.

Page Information Labels the film with the name of the artboard number, the time and date of printout, the line screen used, the screen angle for the separation, and the color of each particular plate. These labels appear at the tops of the images.

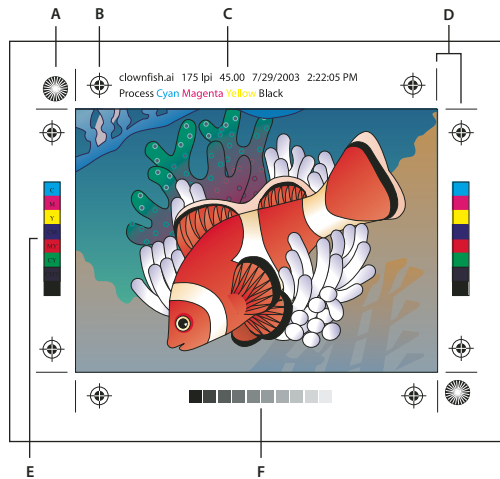

Printer's marks

A. Star target (not optional) B. Registration mark C. Page information D. Trim marks E. Color bar F. Tint bar

Add printer's marks

- 1 Choose File > Print.
- 2 Select Marks & Bleed on the left side of the Print dialog box.
- 3 Select the kinds of printer's marks you want to add. You can also choose between Roman and Japanese-style marks.
- 4 (Optional) If you select Trim Marks, specify the width of trim-mark lines and the offset distance between the trim marks and the artwork.



To avoid drawing printer's marks on a bleed, be sure to enter an Offset value greater than the Bleed value.

More Help topics

[“Specify crop marks for trimming or aligning”](#) on page 46

About bleed

Bleed is the amount of artwork that falls outside of the printing bounding box, or outside the crop area and trim marks. You can include bleed in your artwork as a margin—to ensure that the ink is still printed to the edge of the page after the page is trimmed or that an image can be stripped into a keyline in a document. Once you create the artwork that extends into the bleed, you can use Illustrator to specify the extent of the bleed. Increasing the bleed makes Illustrator print more of the artwork that is located beyond the trim marks. The trim marks still define the same size printing bounding box, however.

The size of the bleed you use depends on its purpose. A *press bleed* (that is, an image that bleeds off the edge of the printed sheet) should be at least 18 points. If the bleed is to ensure that an image fits a keyline, it needs to be no more than 2 or 3 points. Your print shop can advise you on the size of the bleed necessary for your particular job.

Add a bleed

- 1 Choose File > Print.
- 2 Select Marks & Bleed on the left side of the Print dialog box.

3 Do one of the following:

- Enter values for Top, Left, Bottom, and Right to specify the placement of the bleed marks. Click the link icon  to make all the values the same.
- Select Use Document Bleed to use the bleed settings defined in the New Document dialog box.

The maximum bleed you can set is 72 points; the minimum bleed is 0 points.

PostScript printing

PostScript printers use a PPD file (PostScript Printer Description file) to customize the behavior of the driver for your specific PostScript printer. A PPD file contains information about the output device, including printer-resident fonts, available media sizes and orientation, optimized screen frequencies, screen angles, resolution, and color output capabilities. It's important to set up the correct PPD before you print. Selecting the PPD that corresponds to your PostScript printer or imagesetter populates the Print dialog box with the available settings for the output device.

About PPD files

A *PPD file* (PostScript Printer Description file) customizes the behavior of the driver for your specific PostScript printer. It contains information about the output device, including printer-resident fonts, available media sizes and orientation, optimized screen frequencies, screen angles, resolution, and color output capabilities. It's important to set up the correct PPD before you print. Selecting the PPD that corresponds to your PostScript printer or imagesetter populates the Print dialog box with the available settings for the output device. You can switch to a different one to suit your needs. Applications use the information in the PPD file to determine which PostScript information to send to the printer when printing a document.

For best printing results, Adobe recommends that you obtain the latest version of the PPD file for your output device from the manufacturer. Many print service providers and commercial printers have PPDs for the imagesetters they use. Be sure to store PPDs in the location specified by the operating system. For details, consult the documentation for your operating system.

Change the PPD file

When you print to a PostScript printer, PostScript file, or PDF, Illustrator automatically uses the default PPD (PostScript Printer Description) for that device. You can switch to a different one to suit your needs.

1 Choose File > Print.

2 From the PPD menu, select one of the following:

- A PPD that corresponds to the current output device.
- Other. Lets you select a custom PPD, such as one provided by your service bureau for use with the specified printer. The PPD's filename corresponds to the printer's or imagesetter's name and model, and may display a .ppd file extension (depending on how your system is set up.) Navigate to the PPD you want, select it, and click Open.

Note: *Certain PPD features commonly found in imagesetter PPDs aren't accessible from the Illustrator Print dialog box. To set those printer-specific features, click Setup (Windows) or Printer (Mac OS) in the Print dialog box.*

Add a PPD file

For best printing results, Adobe recommends that you obtain the latest version of the PPD file for your output device from the manufacturer. Many print service providers and commercial printers have PPDs for the imagesetters they use. Be sure to store PPDs in the location specified by the operating system. For details, consult the documentation for your operating system.

- ❖ In Windows and in Mac OS, you select a PPD file in the same way you add a printer. The steps for selecting a PPD file are different for each platform. See your operating system documentation for details.

Printing long, complex paths

If you are printing Adobe Illustrator files containing overly long or complicated paths, the file may not print and you may receive limit-check error messages from your printer. To simplify long, complex paths, you can split them into two or more separate paths. You can also change the number of line segments used to approximate curves and adjust the printer resolution.

More Help topics

[“Split a path”](#) on page 77

Change the number of line segments used to print vector objects

Curves in artwork are defined by the PostScript interpreter as small straight line segments; the smaller the line segments, the more accurate the curve. As the number of line segments increases, so does the complexity of the curve. Depending on your printer and the amount of memory it has, a curve may be too complex for a PostScript interpreter to rasterize. In this case, a PostScript limit-check error can result, and the curve won't print.

- 1 Choose File > Print.
- 2 For Printer, select a PostScript printer, Adobe PostScript® File, or Adobe PDF.
- 3 Select Graphics on the left side of the Print dialog box.
- 4 Deselect Automatic, and use the Flatness slider to set the accuracy of curves.

A lower setting (toward Quality) creates more, smaller straight line segments, more closely approximating the curve. A higher setting (toward Speed) results in longer and fewer line segments, creating a less accurate curve, but improving performance.

Split paths for printing

Illustrator treats split paths in the artwork as separate objects. To change your artwork once paths are split, you must either work with the separate shapes or rejoin the paths to work with the image as a single shape.

It's a good idea to save a copy of your original artwork before splitting paths. That way, you still have the original, unsplit file to work with if needed.

- ❖ Do any of the following:
 - To split a stroked path, use the Scissors tool .
 - To split a compound path, choose Object > Compound Paths > Release to remove the compound path. Then break the path into pieces using the Scissors tool, and redefine the pieces as compound paths.
 - To split a mask, choose Object > Clipping Mask > Release to remove the mask. Then break the path into pieces using the Scissors tool, and redefine the pieces as masks.

 To rejoin a path after you split it, select all of the split paths that made up the original object, and click the Add To Shape Area button in the Pathfinder panel. The path is rejoined, with an anchor point placed at each intersection where a split path was reconnected.

Control how fonts are downloaded to a printer

Printer-resident fonts are fonts stored in a printer's memory or on a hard drive connected to the printer. Type 1 and TrueType fonts can be stored either on the printer or on your computer; bitmap fonts are stored only on your computer. Illustrator downloads fonts as needed, provided they are installed on your computer's hard disk.

- 1 Choose File > Print.
- 2 For Printer, select a PostScript printer, Adobe PostScript® File, or Adobe PDF.
- 3 Select Graphics on the left side of the Print dialog box, and select a Download option:

None Includes a reference to the font in the PostScript file which tells the RIP or a post-processor where the font should be included. This option is appropriate if the fonts reside in the printer. TrueType fonts are named according to the PostScript name in the font; however, not all applications can interpret these names. To ensure that TrueType fonts are interpreted correctly, use one of the other font downloading options.

Subset Downloads only the characters (glyphs) used in the document. Glyphs are downloaded once per page. This option typically results in faster and smaller PostScript files when used with single-page documents, or with short documents without much text.

Complete Downloads all fonts required for the document at the beginning of the print job. This option typically results in faster and smaller PostScript files when used with multipage documents.

Note: *Some font manufacturers restrict the embedding of font files. Restrictions apply to copying font software. You are required to comply with applicable copyright law and the terms of your license agreement. For font software licensed from Adobe, your license agreement provides that you may take a copy of the font(s) you have used for a particular file to a commercial printer or other service provider, and the service provider may use the font(s) to process your file, provided the service provider has informed you that it has the right to use that particular software. For other font software, please obtain permission from your vendor.*

More Help topics

[“About fonts”](#) on page 319

Change the PostScript level for printing

When you print to a PostScript or PDF file, Illustrator automatically selects the PostScript level of your output device. If you want to change the Postscript level or data format for PostScript files, do the following:

- 1 Choose File > Print.
- 2 For Printer, select Adobe PostScript® File or Adobe PDF.
- 3 Select Graphics on the left side of the Print dialog box.
- 4 For PostScript, select the level of compatibility with the interpreters in PostScript output devices.

Level 2 improves the printing speed and output quality of graphics printed on a PostScript Level 2 or greater output device. Level 3 provides the best speed and output quality on a PostScript 3 device.

- 5 (Optional) If you chose Adobe PostScript® File as the printer, select a Data Format option to specify how Illustrator sends the image data from your computer to a printer.

Binary exports the image data as binary code, which is more compact than ASCII but may not be compatible with all systems. ASCII exports the image data as ASCII text, which is compatible with older networks and parallel printers and is usually the best choice for graphics used on multiple platforms. It is also usually the best choice for documents used only on Mac OS.

Printing with color management

When you print with color management, you can let Illustrator manage the colors, or you can let the printer manage the colors.

Let your application manage colors when printing

- 1 Choose File > Print.
- 2 Select Color Management on the left side of the Print dialog box.
- 3 For Color Handling, choose Let Illustrator Determine Colors.
- 4 For Printer Profile, select the profile for your output device.

The more accurately the profile describes the behavior of an output device and printing conditions (such as paper type), the more accurately the color management system can translate the numeric values of the actual colors in a document. (See About color profiles.)

- 5 (Optional) Set the Rendering Intent option to specify how the application converts colors to the destination color space.

In most cases, it is best to use the default rendering intent. For more information on rendering intents, search in Help.

- 6 Click Setup (Windows) or Printer (Mac OS) at the bottom of the Print dialog box to access the operating system print settings.
- 7 Access the color management settings for the printer driver by doing one of the following:
 - In Windows, right-click the printer you are using, and select Properties. Then locate the color management settings for the printer driver. For most printer drivers, color management settings are labeled *Color Management* or *ICM*.
 - In Mac OS, select the printer you are using, and select the color management option from the pop-up menu. For most printer drivers, this option is labeled *ColorSync*.
- 8 Turn off color management for the printer driver.

Every printer driver has different color management options. If it's not clear how to turn off color management, consult your printer documentation.

- 9 Return to the Illustrator Print dialog box, and click Print.

Let your printer manage colors when printing

- 1 Choose File > Print.
- 2 Select a PostScript printer from the Printer menu. To print to a file instead of a printer, select Adobe PostScript® File or Adobe PDF.
- 3 Select Color Management on the left side of the Print dialog box.
- 4 For Color Handling, choose Let PostScript® Printer Determine Colors.

5 (Optional) Set any of the following options. In most cases, it is best to use the default settings.

Rendering Intent Specifies how the application converts colors to the destination color space.

Preserve RGB Numbers (for RGB output) or Preserve CMYK Numbers (for CMYK output) Determines how Illustrator handles colors that do not have a color profile associated with them (for example, imported images without embedded profiles). When this option is selected, Illustrator sends the color numbers directly to the output device. When this option is deselected, Illustrator first converts the color numbers to the color space of the output device.

Preserving numbers is recommended when you are following a safe CMYK workflow. Preserving numbers is not recommended for printing RGB documents.

6 Click Setup (Windows) or Printer (Mac OS) at the bottom of the Print dialog box to access the operating system print settings.

7 Access the color management settings for the printer driver by doing one of the following:

- In Windows, right-click the printer you are using, and select Properties. Then locate the color management settings for the printer driver. For most printer drivers, color management settings are labeled *Color Management* or *ICM*.
- In Mac OS, select the printer you are using, and select the color management option from the pop-up menu. For most printer drivers, this option is labeled *ColorSync*.

8 Specify the color management settings to let your printer driver handle the color management during printing.

Every printer driver has different color management options. If it's not clear how to set color management options, consult your printer documentation.

9 Return to the Illustrator Print dialog box, and click Print.

Printing gradients, meshes, and color blends

Files with gradients, meshes, or color blends can be difficult for some printers to print smoothly (without discrete bands of color) or at all.

Printing gradients, meshes, and color blends

Files with gradients, meshes, or color blends can be difficult for some printers to print smoothly (without discrete bands of color) or at all. Follow these general guidelines to improve the printed results:

- Use a blend that changes at least 50% between two or more process-color components.
- Use shorter blends. The optimum length depends on the colors in your blend, but try to keep blends shorter than 7.5 inches.
- Use lighter colors, or make dark blends short. Banding is most likely to occur between very dark colors and white.
- Use an appropriate line screen that retains 256 levels of gray.
- If you create a gradient between two or more spot colors, assign different screen angles to the spot colors when you create color separations. If you're not sure what the angles should be, consult your print shop.
- Print to an output device that supports PostScript® Language Level 3 whenever possible.
- If you have to print to an output device that supports Postscript Language Level 2, or when printing meshes that include transparency, you can choose to rasterize gradients and meshes during printing. As a result, Illustrator converts gradients and meshes from vector objects to JPEG images.

Rasterize gradients and meshes during printing

- 1 Choose File > Print.
- 2 Select Graphics on the left side of the Print dialog box, and select Compatible Gradient And Gradient Mesh Printing.

Important: *The Compatible Gradient And Gradient Mesh Printing option can slow printing on printers that don't have problems with gradients, so only select this option if you experience printing problems.*

Setting the proper screen frequency for printing gradients, meshes, and blends

When printing your file, you may find that the resolution of your printer, when combined with the chosen screen frequency, allows fewer than 256 levels of gray. A higher screen frequency decreases the levels of gray available to the printer. For example, if you are printing at a resolution of 2400 dpi, using a line screen higher than 150 results in fewer than 256 levels of gray. The following table lists the maximum line-screen setting you can use with printers to maintain all 256 levels of gray:

Final Imagesetter Resolution	Maximum Line Screen to Use
300	19
400	25
600	38
900	56
1000	63
1270	79
1446	90
1524	95
1693	106
2000	125
2400	150
2540	159
3000	188
3252	203
3600	225
4000	250

More Help topics

[“Change the printer resolution and screen frequency”](#) on page 418

Calculate the maximum blend length for gradients

Illustrator calculates the number of steps in a gradient based on the percentage of change between the colors in the gradient. The number of steps, in turn, determines the maximum length of the blend before banding occurs.

- 1 Select the Measure tool , and click the beginning point and the endpoint of the gradient.
- 2 Note the distance displayed in the Info panel on a piece of paper. This distance represents the length of the gradient or color blend.
- 3 Calculate the number of steps in the blend using this formula:

Number of steps = 256 (number of grays) X Percentage change in color

To figure out the percentage change in color, subtract the lower color value from the higher color value. For example, a blend between 20% black and 100% black is an 80%—or 0.8—change in color.

When blending process colors, use the largest change that occurs within any one color. For instance, take a blend from 20% cyan, 30% magenta, 80% yellow, and 60% black to 20% cyan, 90% magenta, 70% yellow, and 40% black. This indicates a 60% change, because the greatest change occurs in magenta—from 30% to 90%.

- 4 Using the number of steps calculated in step 3, see if the length of the gradient is larger than the relevant maximum length indicated in the next chart. If it is, reduce the length of the gradient or change the colors.

Number of Steps Adobe Illustrator Recommends	Maximum Blend Length		
	Points	Inches	Cms
10	21.6	.3	.762
20	43.2	.6	1.524
30	64.8	.9	2.286
40	86.4	1.2	3.048
50	108.0	1.5	3.810
60	129.6	1.8	4.572
70	151.2	2.1	5.334
80	172.8	2.4	6.096
90	194.4	2.7	6.858
100	216.0	3.0	7.620
110	237.6	3.3	8.382
120	259.2	3.6	9.144
130	280.8	3.9	9.906
140	302.4	4.2	10.668
150	324.0	4.5	11.430
160	345.6	4.8	12.192
170	367.2	5.1	12.954
180	388.8	5.4	13.716
190	410.4	5.7	14.478
200	432.0	6.0	15.240

Number of Steps Adobe Illustrator Recommends	Maximum Blend Length		
	Points	Inches	Cms
210	453.6	6.3	16.002
220	475.2	6.6	16.764
230	496.8	6.9	17.526
240	518.4	7.2	18.288
250	540.0	7.5	19.050
256	553.0	7.7	19.507

More Help topics

“[Document Info panel overview](#)” on page 302

Printing and saving transparent artwork

When you save an Illustrator file in certain formats, the native transparency information is retained. For example, when you save a file in Illustrator CS (or later) EPS format, the file contains both native Illustrator data and EPS data. When you reopen the file in Illustrator, the native (unflattened) data is read. When you place the file into another application, the EPS (flattened) data is read.

About flattening

If your document or artwork contains transparency, to be output it usually needs to undergo a process called *flattening*. Flattening divides transparent artwork into vector-based areas and rasterized areas. As artwork becomes more complex (mixing images, vectors, type, spot colors, overprinting, and so on), so does the flattening and its results.

Flattening may be necessary when you print or when you save or export to other formats that don't support transparency. To retain transparency without flattening when you create PDF files, save your file as Adobe PDF 1.4 (Acrobat 5.0) or later.

You can specify flattening settings and then save and apply them as transparency flattener presets. Transparent objects are flattened according to the settings in the selected flattener preset.

Note: *Transparency flattening cannot be undone after the file is saved.*



Overlapping art is divided when flattened.

💡 For more information on transparency output issues, see the [Print Service Provider Resources](#) page of the Adobe Solutions Network (ASN) (English only), available on the [Adobe website](#).

File formats that retain transparency

When you save an Illustrator file in certain formats, the native transparency information is retained. For example, when you save a file in Illustrator CS (or later) EPS format, the file contains both native Illustrator data and EPS data. When you reopen the file in Illustrator, the native (unflattened) data is read. When you place the file into another application, the EPS (flattened) data is read.

When possible, keep your file in a format in which native transparency data is retained, allowing you to make edits as necessary.

Native transparency data is retained when you save to the following formats:

- AI9 and later
- AI9 EPS and later
- PDF 1.4 and later (when Preserve Illustrator Editing Capabilities option is selected)

Illustrator flattens artwork when you perform any of the following actions:

- Print a file that contains transparency.
- Save a file that contains transparency in a legacy format such as native Illustrator 8 and earlier, Illustrator 8 EPS and earlier, or PDF 1.3 format. (For the Illustrator and Illustrator EPS formats, you can choose to discard transparency rather than flatten it.)
- Export a file that contains transparency to a vector format that does not understand transparency (such as EMF or WMF).
- Copy and paste transparent art from Illustrator into another application with both the AICB and the Preserve Appearance options checked (in the File Handling & Clipboard section of the Preferences dialog box).
- Export in SWF (Flash) or use the Flatten Transparency command with the Preserve Alpha Transparency option selected. This command lets you preview how artwork will look when exported in SWF.

 For more information on creating and printing transparency, see the *Transparency white paper in the Adobe Technical Info/White Papers folder on the Illustrator CD*. You can also find more information on printing and flattening files with transparency in the *Adobe Illustrator User to User forum*. This is a public forum that offers a wealth of tips and answers to frequently asked questions, and can be found at www.adobe.com/support/forums.

Set transparency flattening options for printing

- 1 Choose File > Print.
- 2 Select Advanced on the left side of the Print dialog box.
- 3 Select a flattening preset from the Preset menu, or click Custom to set specific flattening options.
- 4 If the artwork contains overprinted objects that interact with transparent objects, select an option from the Overprints menu. You can preserve, simulate, or discard overprints.

Note: *If the artwork does not contain transparency, the document will not be flattened and the flattening settings are not relevant. Use the Flattener Preview panel to determine which areas of the artwork contain transparency.*

More Help topics

“[Transparency Flattener options](#)” on page 432

Transparency Flattener options

You can set Transparency Flattener options when creating, editing, or previewing flattener presets in Illustrator, InDesign, or Acrobat.

Highlight (preview) options

None (Color Preview) Disables previewing.

Rasterized Complex Regions Highlights the areas that will be rasterized for performance reasons (as determined by the Rasters/Vectors slider). Keep in mind that the boundary of the highlight area has a higher probability of producing stitching problems (depending on the print-driver settings and the rasterization resolution). To minimize stitching problems, select Clip Complex Regions.

Transparent Objects Highlights the objects that are sources of transparency, such as objects with partial opacity (including images with alpha channels), objects with blending modes, and objects with opacity masks. In addition, note that styles and effects may contain transparency, and overprinted objects may be treated as sources of transparency if they are involved in transparency or if the overprint needs to be flattened.

All Affected Objects Highlights all objects that are involved in transparency, including transparent objects and objects that are overlapped by transparent objects. The highlighted objects will be affected by the flattening process—their strokes or patterns will be expanded, portions of them may get rasterized, and so on.

Affected Linked EPS Files (Illustrator only) Highlights all linked EPS files that are affected by transparency.

Affected Graphics (InDesign only) Highlights all placed content affected by transparency or transparency effects. This option is useful for service providers who need to see graphics that require attention to print properly.

Expanded Patterns (Illustrator and Acrobat) Highlights all patterns that will be expanded if involved in transparency.

Outlined Strokes Highlights all strokes that will be outlined if involved in transparency or because Convert All Strokes To Outlines is selected.

Outlined Text (Illustrator and InDesign) Highlights all text that will be outlined if involved in transparency or because Convert All Text To Outlines is selected.

Note: In the final output, outlined strokes and text may appear slightly different from native ones, especially very thin strokes and very small text. However, the Flattener Preview doesn't highlight this altered appearance.

Raster-Fill Text And Strokes (InDesign only) Highlights text and strokes that have rasterized fills as a result of flattening.

All Rasterized Regions (Illustrator and InDesign) Highlights objects and intersections of objects that will be rasterized because there is no other way of representing them in PostScript or because they are more complex than the threshold specified by the Rasters/Vectors slider. For example, the intersection of two transparent gradients will always be rasterized, even if the Rasters/Vectors value is 100. The All Rasterized Regions option also shows raster graphics (such as Photoshop files) involved in transparency, and raster effects such as drop shadows and feathers. Note that this option takes longer to process than the others.

Transparency Flattener Preset options

Name/Preset Specifies the name of the preset. Depending on the dialog box, you can type a name in the Name text box or accept the default. You can enter the name of an existing preset to edit that preset. However, you can't edit the default presets.

Raster/Vector balance Specifies the amount of vector information that will be preserved. Higher settings preserve more vector objects, while lower settings rasterize more vector objects; intermediate settings preserve simple areas in vector form and rasterize complex ones. Select the lowest setting to rasterize all the artwork.

Note: The amount of rasterization that occurs depends on the complexity of the page and the types of overlapping objects.

Line Art And Text Resolution Rasterizes all objects, including images, vector artwork, text, and gradients, to the specified resolution. Acrobat and InDesign allow a maximum of 9600 pixels per inch (ppi) for line art, and 1200 ppi for gradient mesh. Illustrator allows a maximum of 9600 ppi for both line art and gradient mesh. The resolution affects

the precision of intersections when flattened. Line Art and Text Resolution should generally be set to 600-1200 to provide high-quality rasterization, especially on serif or small point sized type.

Gradient And Mesh Resolution Specifies the resolution for gradients and Illustrator mesh objects rasterized as a result of flattening, from 72 to 2400 ppi. The resolution affects the precision of intersections when flattened. Gradient and mesh resolution should generally be set between 150 and 300 ppi, because the quality of the gradients, drop shadows, and feathers do not improve with higher resolutions, but printing time and file size increase.

Convert All Text To Outlines Converts all type objects (point type, area type, and path type) to outlines and discards all type glyph information on pages containing transparency. This option ensures that the width of text stays consistent during flattening. Note that enabling this option will cause small fonts to appear slightly thicker when viewed in Acrobat or printed on low-resolution desktop printers. It doesn't affect the quality of the type printed on high-resolution printers or imagesetters.

Convert All Strokes To Outlines Converts all strokes to simple filled paths on pages containing transparency. This option ensures that the width of strokes stays consistent during flattening. Note that enabling this option causes thin strokes to appear slightly thicker and may degrade flattening performance.

Clip Complex Regions Ensures that the boundaries between vector artwork and rasterized artwork fall along object paths. This option reduces stitching artifacts that result when part of an object is rasterized while another part of the object remains in vector form. However, selecting this option may result in paths that are too complex for the printer to handle.

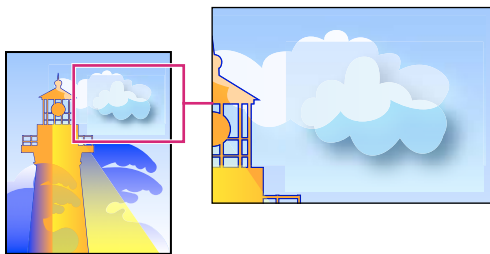

Stitching, where rasters and vectors meet.

Note: Some print drivers process raster and vector art differently, sometimes resulting in color stitching. You may be able to minimize stitching problems by disabling some print-driver specific color-management settings. These settings vary with each printer, so see the documentation that came with your printer for details.

(Illustrator only) Select Preserve Alpha Transparency (Flatten Transparency dialog box only) Preserves the overall opacity of flattened objects. With this option, blending modes and overprints are lost, but their appearance is retained within the processed artwork, along with the level of alpha transparency (as when you rasterize artwork using a transparent background). Preserve Alpha Transparency can be useful if you are exporting to SWF or SVG, since both of these formats support alpha transparency.

(Illustrator only) Select Preserve Spot Colors And Overprints (Flatten Transparency dialog box only) Generally preserves spot colors. It also preserves overprinting for objects that aren't involved in transparency. Select this option when printing separations if the document contains spot colors and overprinted objects. Deselect this option when saving files for use in page-layout applications. With this option selected, overprinted areas that interact with transparency are flattened, while overprinting in other areas is preserved. The results are unpredictable when the file is output from a page-layout application.

Preserve Overprint (Acrobat only) Blends the color of transparent artwork with the background color to create an overprint effect.

Preview which areas of artwork will be flattened

Use the preview options in the Flattener Preview to highlight areas that are affected by flattening. You can use this color-coded information to adjust flattening options.

Note: The Flattener Preview is not intended for precise previewing of spot colors, overprints, and blending modes. Instead, use Overprint Preview mode for those purposes.

- 1 Display the Flattener Preview panel (or dialog box):
 - In Illustrator, choose Window > Flattener Preview.
 - In Acrobat, choose Advanced > Print Production > Flattener Preview.
 - In InDesign, choose Window > Output > Flattener Preview.
- 2 From the Highlight menu, choose the kind of areas you want to highlight. The availability of options depends on the content of the artwork.
- 3 Select the flattening settings you want to use: Either choose a preset or, if available, set specific options.

Note: (Illustrator) If the flattening settings aren't visible, select Show Options from the panel menu to display them.

- 4 If the artwork contains overprinted objects that interact with transparent objects, in Illustrator, select an option from the Overprints menu. You can preserve, simulate, or discard overprints. In Acrobat, choose Preserve Overprint to blend the color of transparent artwork with the background color to create an overprint effect.
- 5 At any time, click Refresh to display a fresh preview version based on your settings. Depending on the complexity of the artwork, you may need to wait a few seconds for the preview image to appear. In InDesign, you can also choose Auto Refresh Highlight.

 *In Illustrator and Acrobat, to magnify the preview, click in the preview area. To zoom out, Alt-click/Option-click in the preview area. To pan the preview, hold down the spacebar and drag in the preview area.*

More Help topics

[“About flattening”](#) on page 431

Flattener Preview panel overview

You use the preview options in the Flattener Preview panel to highlight the areas affected by flattening artwork. You can use this information to adjust the flattening options, and even use the panel to save flattener presets. To display the Flattener Preview panel, choose Window > Flattener Preview.

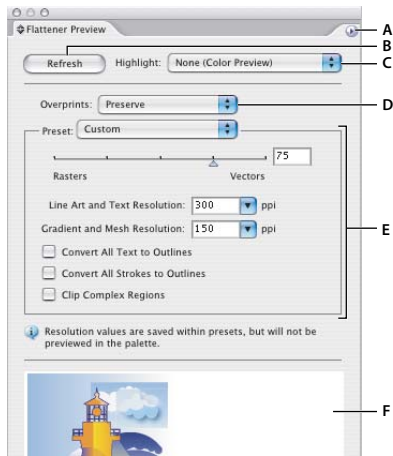
Printing*Flattener Preview panel*

A. Panel menu B. Refresh button C. Highlight menu D. Overprint menu E. Transparency flattening settings F. Preview area

You can control the speed and quality of the preview image by selecting an option from the panel menu. Select Quick Preview to compute the quickest preview; select Detailed Preview to add the option All Rasterized Regions to the Highlight pop-up menu (this option is more performance-intensive to compute).

 *Keep in mind that the Flattener Preview panel is not intended for precise previewing of spot colors, overprints, blending modes, and image resolution. Use Overprint Preview mode in Illustrator to preview spot colors, overprints, and blending modes as they will appear when output.*

More Help topics

[“Transparency Flattener options”](#) on page 432

About transparency flattener presets

If you regularly print or export documents that contain transparency, you can automate the flattening process by saving flattening settings in a *transparency flattener preset*. You can then apply these settings for print output as well as for saving and exporting files to PDF 1.3 (Acrobat 4.0) and EPS and PostScript formats. In addition, in Illustrator you can apply them when saving files to earlier versions of Illustrator or when copying to the clipboard; in Acrobat, you can also apply them when optimizing PDFs.

These settings also control how flattening occurs when you export to formats that don’t support transparency.

You can choose a flattener preset in the Advanced panel of the Print dialog box or of the format-specific dialog box that appears after the initial Export or Save As dialog box. You can create your own flattener presets or choose from the default options provided with the software. The settings of each of these defaults are designed to match the quality and speed of the flattening with an appropriate resolution for rasterized transparent areas, depending on the document’s intended use:

[High Resolution] is for final press output and for high-quality proofs, such as separations-based color proofs.

[Medium Resolution] is for desktop proofs and print-on-demand documents that will be printed on PostScript color printers.

[Low Resolution] is for quick proofs that will be printed on black-and-white desktop printers and for documents that will be published on the web or exported to SVG.

Create or edit a transparency flattener preset

You can save transparency flattener presets in a separate file, making it easy to back them up or to make them available to your service providers, clients, or others in your workgroup. In InDesign, transparency flattener preset files have an .flst extension.

- 1 Choose Edit > Transparency Flattener Presets.
- 2 Do one of the following:
 - To create a new preset, click New.
 - To base a preset on a predefined preset, select one in the list and click New.
 - To edit an existing preset, select the preset and click Edit.

Note: You can't edit the default flattener presets.

- 3 Set flattening options.
- 4 Click OK to return to the Transparency Flattener Presets dialog box, and click OK again.

Export and import a custom transparency flattener preset

You can export and import transparency flattener presets in order to share them with your service providers, your clients, or others in your workgroup.

- 1 Choose Edit > Transparency Flattener Presets.
- 2 Select a preset in the list.
- 3 Do one of the following:
 - To export a preset to a separate file, click Save (InDesign) or Export (Illustrator), specify a name and location, and then click Save.

Consider saving the preset outside of the application's preferences folder. That way, it won't be lost if you delete your preferences.

- To import presets from a file, click Load (InDesign) or Import (Illustrator). Locate and select the file containing the preset you want to load, and then click Open.

Rename or delete a custom transparency flattener preset

- 1 Choose Edit > Transparency Flattener Presets.
- 2 Select a preset in the list.
- 3 Do one of the following:
 - To rename an existing preset, click Edit, type a new name, and then click OK.
 - To delete a preset, click Delete, and then click OK to confirm the deletion.

Note: You cannot delete the default presets.

Flatten transparency for individual objects

The Flatten Transparency command lets you see what your artwork will look like when flattened. For instance, you might use this command before saving the file in SWF (Flash) format or if you are having problems printing legacy art where transparency may be the culprit.

- 1 Select the object.

- 2 Choose Object > Flatten Transparency.
- 3 Select the flattening settings you want to use, either by choosing a preset or setting specific options.
- 4 Click OK.

 To save the flattening settings for use with other objects and documents in the current session, click *Save Preset*. If you want to create a permanent preset, choose *Edit > Transparency Flattener Presets* instead.

More Help topics

[“Transparency Flattener options”](#) on page 432

Rasterize all artwork during printing

When you print to a low-resolution or non-PostScript printer, such as a desktop inkjet printer, you can choose to rasterize all artwork during printing. This option is useful when printing documents that contain complex objects (such as objects with smooth shading or gradients) because it reduces the possibility of errors.

- 1 Choose File > Print.
- 2 Select Advanced on the left side of the Print dialog box.
- 3 Select Print As Bitmap.

This option is only available if the printer driver for the selected printer supports bitmap printing.

Overprinting

By default, when you print opaque, overlapping colors, the top color knocks out the area underneath. *Overprinting* prevents knockouts and makes the topmost overlapping printing ink appear transparent in relation to the underlying ink.

Where colors printed from separate plates overlap or adjoin one another, press misregistration can cause gaps between colors on the final output. To compensate for potential gaps between colors in artwork, print shops use a technique called *trapping* to create a small area of overlap (called a *trap*) between two adjoining colors. You can use a separate, dedicated trapping program to create traps automatically, or you can use Illustrator to create traps manually.

About overprinting

By default, when you print opaque, overlapping colors, the top color knocks out the area underneath. You can use overprinting to prevent knockout and make the topmost overlapping printing ink appear transparent in relation to the underlying ink. The degree of transparency in printing depends on the ink, paper, and printing method used. Consult your print shop to determine how these variables will affect your final artwork.

You may want to overprint in the following situations:

- Overprint black ink to aid in registration. Because black ink is opaque (and usually the last to be printed), it doesn't look much different when printed over a color as opposed to a white background. Overprinting black can prevent gaps from appearing between black and colored areas of your artwork.
- Overprint when the artwork does not share common ink colors and you want to create a trap or overlaid ink effects. When overprinting process color mixes or custom colors that do not share common ink colors, the overprint color is added to the background color. For example, if you print a fill of 100% magenta over a fill of 100% cyan, the overlapping fills appear violet, not magenta.

After you set overprinting options, you should use the Overprint Preview mode (View > Overprint Preview) to see an approximation of how the overprinting colors will print. You should also carefully check overprinted colors on separated artwork using integral proofs (where each separation is shown in register on a single piece of paper) or overlay proofs (where the separations are shown in register on separate plastic sheets stacked on top of each other).

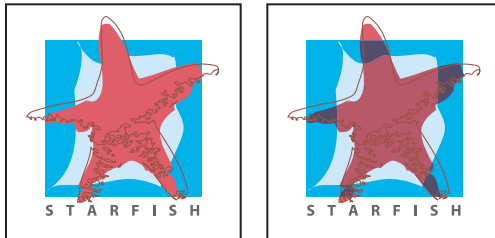

Colors knocked out (by default) and with overprinting

Set up overprinting

- 1 Select the object or objects that you want to overprint.
- 2 In the Attributes panel, select Overprint Fill, Overprint Stroke, or both.

 If you use the Overprint option on a 100% black stroke or fill, the black ink may not be opaque enough to prevent the underlying ink colors from showing through. To eliminate the show-through problem, use a four-color (rich) black instead of a 100% black. Consult with your print shop about the exact percentages of color to add to the black.

Overprint black

To overprint all black in your artwork, select the Overprint Black option in the Print dialog box when you create color separations. This option works on all objects that have black applied through the K color channel. However, it does not work for objects that appear black because of their transparency settings or graphic styles.

You can also use the Overprint Black command to set up overprinting for objects that contain a specific percentage of black. To use the Overprint Black command:

- 1 Select all the objects you might want to overprint.
- 2 Choose Edit > Edit Colors > Overprint Black.
- 3 Enter the percentage of black you want to overprint. All objects with the specified percentage will overprint.
- 4 Select Fill, Stroke, or both to specify how to apply the overprinting.
- 5 To overprint process colors that include cyan, magenta, or yellow as well as the specified percentage of black, select Include Blacks with CMY.
- 6 To overprint spot colors whose process equivalents include the specified percentage of black, select Include Spot Blacks. If you are overprinting a spot color that contains process colors as well as the specified percentage of black, select both Include Blacks with CMY and Include Spot Blacks.

 To remove overprinting from objects that contain a specific percentage of black, select Remove Black instead of Add Black in the Overprint Black dialog box.

Simulate or discard overprinting

In most cases, only separation devices support overprinting. When you print to a composite, or when your artwork contains overprinted objects that interact with transparency objects, you choose to simulate or discard overprinting.

- 1 Choose File > Print.

- 2 Select Advanced on the left side of the Print dialog box.
- 3 Select Simulate or Discard from the Overprints menu.

Trapping

About trapping

Where colors printed from separate plates overlap or adjoin one another, press misregistration can cause gaps between colors on the final output. To compensate for potential gaps between colors in artwork, print shops use a technique called *trapping* to create a small area of overlap (called a *trap*) between two adjoining colors. You can use a separate, dedicated trapping program to create traps automatically, or you can use Illustrator to create traps manually.

There are two types of trap: a *spread*, in which a lighter object overlaps a darker background and seems to expand into the background; and a *choke*, in which a lighter background overlaps a darker object that falls within the background and seems to squeeze or reduce the object.

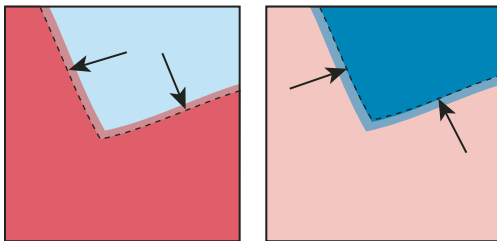

Spread (object overlaps background) compared to choke (background overlaps object)

When overlapping painted objects share a common color, trapping may be unnecessary if the color that is common to both objects creates an automatic trap. For example, if two overlapping objects contain cyan as part of their CMYK values, any gap between them is covered by the cyan content of the object underneath.

Trapping type can present special problems. Avoid applying mixed process colors or tints of process colors to type at small point sizes, because any misregistration can make the text difficult to read. Likewise, trapping type at small point sizes can result in hard-to-read type. As with tint reduction, check with your print shop before trapping such type. For example, if you are printing black type on a colored background, simply overprinting the type onto the background may be enough.

Create a trap

The Trap command creates traps for simple objects by identifying the lighter-colored artwork—whether it's the object or the background—and overprinting (trapping) it into the darker artwork. You can apply the Trap command from the Pathfinder panel or as an effect. The advantage of using the Trap effect is that you can alter the trap settings at any time.

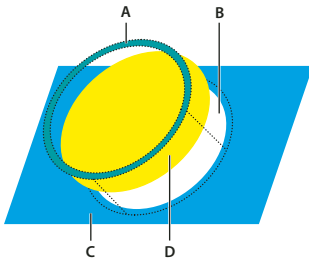

What the Trap command does

A. Area of overprinting B. Area of knockout C. Background color D. Foreground color

In some cases, the top and bottom objects may have similar color densities so that one color is not obviously darker than the other. In this case, the Trap command determines the trap based on slight differences in color; if the trap specified by the Trap dialog box is not satisfactory, you can use the Reverse Trap option to switch the way in which the Trap command traps the two objects.

- 1 If the document is in RGB mode, choose File > Document Color Mode > CMYK Color to convert it to CMYK Mode.
- 2 Select two or more objects.
- 3 Do one of the following:
 - To apply the command directly to the objects, choose Window > Pathfinder, and choose Trap from the panel menu.
 - To apply the command as an effect, choose Effect > Pathfinder > Trap. Select Preview if you want to preview the effect.
- 4 Set trap options, and click OK.

More Help topics

[“About effects”](#) on page 367

[“Apply Pathfinder effects”](#) on page 241

[“Pathfinder panel overview”](#) on page 240

Trap options

Thickness Specifies a stroke width between 0.01 and 5000 points. Check with your print shop to determine what value to use.

Height/Width Specifies the trap on horizontal lines as a percentage of the trap on vertical lines. Specifying different horizontal and vertical trap values lets you compensate for on-press irregularities, such as paper stretch. Contact your print shop for help in determining this value. The default value of 100% results in the same trap width on horizontal lines and on vertical lines. To increase the trap thickness on horizontal lines without changing the vertical trap, set the Height/Width value to greater than 100%. To decrease the trap thickness on horizontal lines without changing the vertical trap, set the Height/Width value to less than 100%.

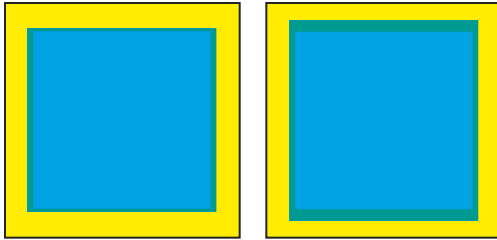

Height/Width set to 50% (left) compared to 200% (right)

Tint Reduction Reduces the tint of the lighter color being trapped; the darker color remains at 100%. This option is useful when trapping two light-colored objects, where the trap line may show through the darker of the two colors, resulting in an unsightly dark border. For example, if you trap a light yellow object into a light blue object, a bright green border is visible where the trap is created. Check with your print shop to find out what percentage of tint is most appropriate given the type of press, inks, paper stock, and so on being used.

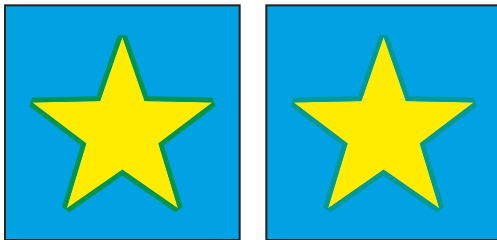

Tint reduction value of 100% (trap contains 100% of lighter color) compared to tint reduction value of 50% (trap contains 50% of lighter color)

Traps With Process Color Converts spot-color traps to equivalent process colors. This option creates an object of the lighter of the spot colors and overprints it.

Reverse Traps Traps darker colors into lighter colors. This option does not work with rich black—that is, black that contains additional CMY inks.

Precision (as effect only) Affects how precisely an object's path is calculated. The more precise the calculation, the more accurate the drawing and the more time is required to generate the resulting path.

Remove Redundant Points (as effect only) Removes unnecessary points.

Create a spread or choke

For more precise control of trapping and for trapping complex objects, you can create the effect of a trap by stroking an object and setting the stroke to overprint.

- 1 Select the topmost object of the two objects that must trap into each other.
- 2 In the Stroke box in the Tools panel or the Color panel, do one of the following:
 - Create a spread by entering the same color values for the Stroke as appear in the Fill box. You can change the stroke's color values by selecting the stroke and then adjusting its color values in the Color panel. This method enlarges the object by stroking its boundaries with the same color as the object's fill.

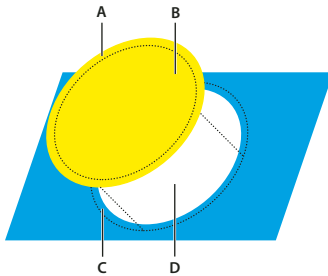

Object stroked with fill color

A. Overprinted stroke creates spread trap B. Fill creates knockout C. Area of trap D. Area of knockout

- Create a choke by entering the same color values for the Stroke as appear in the lighter background (again, using the Color panel); the Stroke and Fill values will differ. This method reduces the darker object by stroking its boundaries with the lighter background color.

3 Choose Window > Stroke.

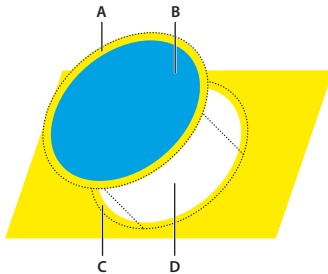

Object stroked with background color

A. Overprinted stroke creates choke trap B. Fill creates knockout C. Area of trap D. Area of knockout

4 In the Weight text box, enter a stroke width of between 0.01 and 1000 points. Check with your print shop to determine what value to use.

For example, a stroke weight of 0.6 point creates a trap of 0.3 point. A stroke weight of 2.0 points creates a trap of 1.0 point.

5 Choose Window > Attributes.

6 Select Overprint Stroke.

Trap a line

1 Select the line to be trapped.

2 In the Stroke box in the Tools panel or the Color panel, assign the stroke a color of white.

3 In the Stroke panel, select the desired line weight.

4 Copy the line, and choose Edit > Paste In Front. The copy is used to create a trap.

5 In the Stroke box in the Tools panel or the Color panel, stroke the copy with the desired color.

6 In the Stroke panel, choose a line weight that is wider than the bottom line.

7 Choose Window > Attributes.

8 Select Overprint Stroke for the top line.

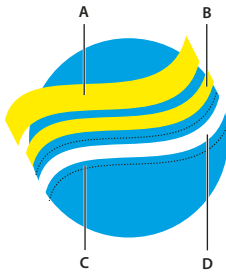

Copy of stroke used for spread trap

A. Overprinted top stroke creates spread trap B. Bottom stroke creates knockout C. Area of knockout D. Area of trap

Trap a portion of an object

- 1 Draw a line along the edge or edges that you want to trap. If the object is complex, use the Direct Selection tool  to select the edges to be trapped, copy them, and choose Edit > Paste In Front to paste the copy directly on top of the original.

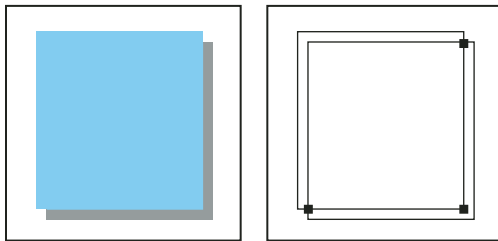

Drop shadow with a trap (left) is based on the line drawn where the object and its drop shadow meet (right).

- 2 In the Stroke box in the Tools panel or the Color panel, select a color value for the Stroke to create either a spread or a choke.
- 3 Choose Window > Attributes.
- 4 Select Overprint Stroke.

Print presets

If you regularly output to different printers or job types, you can automate print jobs by saving all output settings as print presets. Using print presets is a fast, reliable way to print jobs that require consistently accurate settings for many options in the Print dialog box.

Create print presets

If you regularly output to different printers or job types, you can automate print jobs by saving all output settings as print presets. Using print presets is a fast, reliable way to print jobs that require consistently accurate settings for many options in the Print dialog box.

You can save and load print presets, making it easy to back them up or to make them available to your service providers, clients, or others in your workgroup.

You can create and review print presets in the Print Presets dialog box.

- ❖ Do one of the following:
 - Choose File > Print, adjust print settings, and click Save Preset . Type a name or use the default, and then click OK. With this method, the preset is saved in the preferences file.
 - Choose Edit > Print Presets, and then click New. In the Print Presets dialog box, type a new name or use the default, adjust print settings, and then click OK to return to the Print Presets dialog box. Then click OK again.

Apply print presets

- 1 Choose File > Print.
- 2 Choose a print preset from the Print Preset menu. If you like, confirm the printer settings in the Print dialog box.
- 3 Click Print.

Edit print presets

- ❖ Do one of the following:
 - Choose File > Print, adjust print settings, and click Save Preset . In the Save Preset dialog box that appears, either type a name in the text box or use the current name. (If the current name is an existing preset, saving overwrites that preset's settings.) Click OK.
 - Choose Edit > Print Presets, select a preset from the list, and then click Edit. Adjust print settings, and click OK to return to the Print Presets dialog box. Then click OK again.

 You can edit the default preset as you would any other using the steps outlined above.

Delete print presets

- 1 Choose Edit > Print Presets.
- 2 Select one or more presets from the list and click Delete. Shift-click to select adjacent presets. Ctrl-click (Windows) or Command-click (Mac OS) to select nonadjacent presets.

Export or import print presets

You can save print presets in separate files, making it easy to back them up or to make them available to your service providers, clients, or others in your workgroup.

- 1 Choose Edit > Print Presets.
- 2 Do one of the following:
 - To export presets, select one or more presets in the list and click Export. Shift-click to select adjacent presets. Ctrl-click (Windows) or Command-click (Mac OS) to select nonadjacent presets. Specify a name and location, and then click Save.
 - To import presets, click Import. Locate and click the file containing the presets you want to load, and then click OK.

 Consider saving presets outside of the preferences folder. That way, they won't be lost if you ever delete your preferences.

View a summary of print settings/presets

Use the Summary panel of the Print dialog box to view your output settings prior to printing, and then adjust them as necessary. For example, you can see if the document will omit certain graphics for OPI replacement by the service provider.

- 1 Choose File > Print.
- 2 In the Print dialog box, click Summary.
- 3 If you want to save the summary as a text file, click Save Summary.
- 4 Accept the default filename or type another name for the text file, and click Save.

Chapter 14: Automating tasks

Actions

About actions

An *action* is a series of tasks that you play back on a single file or a batch of files—menu commands, panel options, tool actions, and so on. For example, you can create an action that changes the size of an image, applies an effect to the image, and then saves the file in the desired format.

Actions can include steps that let you perform tasks that cannot be recorded (for example, using a painting tool). Actions can also include modal controls that let you enter values in a dialog box while playing an action.

In Photoshop, actions are the basis for *droplets*, which are small applications that automatically process all files that are dragged onto their icon.

Photoshop and Illustrator come with predefined actions installed that help you perform common tasks. You can use these actions as is, customize them to meet your needs, or create new actions. Actions are stored in sets to help you organize them.

You can record, edit, customize, and batch-process actions, and you can manage groups of actions by working with action sets.

Actions panel overview

You use the Actions panel (Window > Actions) to record, play, edit, and delete individual actions. This panel also lets you save and load action files.

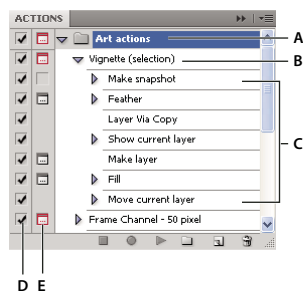

Photoshop Actions panel

A. Action set B. Action C. Recorded commands D. Included command E. Modal control (toggles on or off)

Expand and collapse sets, actions, and commands

- ❖ Click the triangle to the left of the set, action, or command in the Actions panel. Alt-click (Windows) or Option-click (Mac OS) the triangle to expand or collapse all actions in a set or all commands in an action.

View actions by name only

- ❖ Choose Button Mode from the Actions panel menu. Choose Button Mode again to return to list mode.

Note: You can't view individual commands or sets in Button mode.

Select actions in the Actions panel

- ❖ Click an action name. Shift-click action names to select multiple, contiguous actions, and Ctrl-click (Windows) or Command-click (Mac OS) action names to select multiple, discontinuous actions.

Play an action on a file

Playing an action executes the action's recorded commands in the active document. (Some actions require that you make a selection before playing; some can be executed on an entire file.) You can exclude specific commands from an action or play only a single command. If the action includes a modal control, you can specify values or use tools in a dialog box when the action pauses.

Note: In Button mode, clicking a button executes the entire action—although commands previously excluded are not executed.

- 1 If necessary, select objects on which to play the action, or open a file.
- 2 Do one of the following:
 - (Illustrator) To play a set of actions, select the set name, and click the Play button  in the Actions panel, or choose Play from the panel menu.
 - To play an entire single action, select the action name, and click the Play button in the Actions panel, or choose Play from the panel menu.
 - If you assigned a key combination to the action, press that combination to play the action automatically.
 - To play only a part of an action, select the command from which you want to start playing, and click the Play button in the Actions panel, or choose Play from the panel menu.
 - To play a single command, select the command, and then Ctrl-click (Windows) or Command-click (Mac OS) the Play button in the Actions panel. You can also press Ctrl (Windows) or Command (Mac OS), and double-click the command.

 *In Photoshop, to undo an action, take a snapshot in the History panel before you play an action, and then select the snapshot to undo the action.*

Record an action

When you create a new action, the commands and tools you use are added to the action until you stop recording.

 *To guard against mistakes, work in a copy: at the beginning of the action before applying other commands, record the File > Save A Copy command (Illustrator) or record the File > Save As command and select As A Copy (Photoshop). Alternatively, in Photoshop you can click the New Snapshot button on the History panel to make a snapshot of the image before recording the action.*

- 1 Open a file.
- 2 In the Actions panel, click the Create New Action button , or choose New Action from the Actions panel menu.
- 3 Enter an action name, select an action set, and set additional options:

Function Key Assigns a keyboard shortcut to the action. You can choose any combination of a function key, the Ctrl key (Windows) or Command key (Mac OS), and the Shift key (for example, Ctrl+Shift+F3), with these exceptions: In Windows, you cannot use the F1 key, nor can you use F4 or F6 with the Ctrl key.

Note: If you assign an action the same shortcut that is used for a command, the shortcut will apply the action rather than the command.

Color Assigns a color for display in Button mode.

- 4 Click Begin Recording. The Begin Recording button in the Actions panel turns red .

Important: When recording the Save As command, do not change the filename. If you enter a new filename, that new name is recorded and used each time you run the action. Before saving, if you navigate to a different folder, you can specify a different location without having to specify a filename.

- 5 Perform the operations and commands you want to record.

Not all tasks in actions can be recorded directly; however, you can insert most nonrecordable tasks using commands in the Actions panel menu.

- 6 To stop recording, either click the Stop Playing/Recording button, or choose Stop Recording from the Actions panel menu. (In Photoshop, you can also press the Esc key.)

 To resume recording in the same action, choose Start Recording from the Actions panel menu.

Insert nonrecordable tasks into actions

Not all tasks in actions can be recorded directly. For example, you can't record commands in the Effects and View menus, commands that display or hide panels, and use of the Selection, Pen, Paintbrush, Pencil, Gradient, Mesh, Eyedropper, Live Paint Bucket, and Scissors tools.

To tell which tasks cannot be recorded, watch the Actions panel. If the name of the command or tool doesn't appear after you perform the task, you may still be able to add the task using commands in the Actions panel menu.

 To insert a nonrecordable task after you create an action, select an item within the action after which you want to insert the task. Then choose the appropriate command from the Actions panel menu.

More Help topics

[“Actions panel overview”](#) on page 447

Insert a nonrecordable menu command

- 1 Choose Insert Menu Item from the Actions panel menu.
- 2 Select the command from its menu, or begin typing the command name in the text box, and click Find. Then click OK.

Insert a path

- ❖ Select the path, and choose Insert Select Path from the Actions panel menu.

Insert selection of an object

- 1 Enter a name for the object in the Note box of the Attributes panel before you start recording. (Select Show Note from the Attributes panel menu to display the Note box.)
- 2 When you record the action, choose Select Object from the Actions panel menu.
- 3 Enter the name of the object, and click OK.

Record optimization options for multiple slices in the Save For Web dialog box

- ❖ Set the slice optimization options before you start recording the action; then press Alt (Windows) or Option (Mac OS) and click Remember in the Save For Web dialog box.

When you record the action, Illustrator will remember the settings.

Insert a stop

You can include stops in an action that let you perform a task that cannot be recorded (for example, using a painting tool). After you complete the task, click the Play button in the Actions panel to complete the action.

You can also display a short message when the action reaches the stop as a reminder of what needs to be done before continuing with the action. You can include a Continue button in the message box in case no other task needs to be done.



- 1 Choose where to insert the stop by doing one of the following:
 - Select an action's name to insert a stop at the end of the action.
 - Select a command to insert a stop after the command.
- 2 Choose Insert Stop from the Actions panel menu.
- 3 Type the message you want to appear.
- 4 If you want the option to continue the action without stopping, select Allow Continue.
- 5 Click OK.



You can insert a stop when recording an action or after it has been recorded.

Change settings when playing an action

By default, actions are completed using the values specified when they were originally recorded. If you want to change the settings for a command within an action, you can insert a *modal control*. A modal control pauses an action so that you can specify values in a dialog box or use a modal tool. (A modal tool requires pressing Enter or Return to apply its effect—once you press Enter or Return, the action resumes its tasks.)

A modal control is indicated by a dialog box icon  to the left of a command, action, or set in the Actions panel. A red dialog box icon  indicates an action or set in which some, but not all, commands are modal. You can't set a modal control in Button mode.

- ❖ Do one of the following:
 - To enable a modal control for a command within an action, click the box to the left of the command name. Click again to disable the modal control.
 - To enable or disable modal controls for all commands in an action, click the box to the left of the action name.
 - To enable or disable modal controls for all actions in a set, click the box to the left of the set name.

Exclude commands from an action

You can exclude commands that you don't want to play as part of a recorded action. You can't exclude commands in Button mode.

- 1 If necessary, expand the listing of commands in the action by clicking the triangle to the left of the action name in the Actions panel.
- 2 Do one of the following:
 - To exclude a single command, click to clear the check mark to the left of the command name. Click again to include the command.
 - To exclude or include all commands or actions in an action or set, click the check mark to the left of the action or set name.

- To exclude or include all commands *except* the selected command, Alt-click (Windows) or Option-click (Mac OS) its check mark.

To indicate that some of the commands within the action are excluded, in Photoshop the check mark of the parent action turns red; in Illustrator the check mark of the parent action becomes dimmed.

Specify playback speed

You can adjust an action's playback speed or pause it to help you debug an action.

- 1 Choose Playback Options from the Actions panel menu.
- 2 Specify a speed, and click OK:

Accelerated Plays the action at normal speed (the default).

Note: When you play an action at accelerated speed, the screen may not update as the action executes—files may be opened, modified, saved, and closed without ever appearing on-screen, enabling the action to execute more quickly. If you want to see the files on-screen as the action executes, specify the Step By Step speed instead.

Step By Step Completes each command and redraws the image before going on to the next command in the action.

Pause For __ Seconds Specifies the amount of time the application should pause between carrying out each command in the action.

Edit and rerecord actions

It is easy to edit and customize actions. You can tweak the settings of any specific command within an action, add commands to an existing action, or step through an entire action and change any or all settings.

More Help topics

[“Actions panel overview”](#) on page 447

Add commands to an action

- 1 Do one of the following:
 - Select the action name to insert a new command at the end of the action.
 - Select a command in the action to insert a command after it.
- 2 Click the Begin Recording button, or choose Start Recording from the Actions panel menu.
- 3 Record the additional commands.
- 4 When finished, click the Stop Playing/Recording button in the Actions panel or choose Stop Recording from the panel menu.

Rearrange commands within an action

- ❖ In the Actions panel, drag a command to its new location within the same or another action. When the highlighted line appears in the desired position, release the mouse button.

Record an action again

- 1 Select an action, and choose Record Again from the Actions panel menu.
- 2 If a modal tool appears, use the tool to create a different result, and press Enter or Return, or just press Enter or Return to retain the same settings.

- 3 If a dialog box appears, change the settings, and click OK to record them, or click Cancel to retain the same values.

Record a single task again

- 1 Select an object of the same type for which you want to rerecord the action. For example, if a task is only available for vector objects, you must have a vector object selected when you rerecord.
- 2 In the Actions panel, double-click the command.
- 3 Enter the new values and click OK.

Manage action sets

You can create and organize sets of task-related actions that can be saved to disk and transferred to other computers.

Note: Any actions that you create are automatically listed in the Actions panel, but to truly save an action and not risk losing it if you delete your preferences file (Illustrator) or Actions panel file (Photoshop), you have to save it as part of an action set.

Save a set of actions

- 1 Select a set.



If you want to save a single action, first create an action set and move the action to the new set.

- 2 Choose Save Actions from the Actions panel menu.
- 3 Type a name for the set, choose a location, and click Save.

You can save the file anywhere. You can save only the entire contents of a set in the Actions panel, not individual actions.

Note: (Photoshop only) If you place the saved action-set file in the Presets/Actions folder, the set will appear at the bottom of the Actions panel menu after you restart the application.



(Photoshop only) Press Ctrl+Alt (Windows) or Command+Option (Mac OS) when you choose the Save Actions command to save the actions in a text file. You can use this file to review or print the contents of an action. However, you can't reload the text file back into Photoshop.

Load a set of actions

By default, the Actions panel displays predefined actions (shipped with the application) and any actions you create. You can also load additional actions into the Actions panel.

- ❖ Do one of the following:
 - Choose Load Actions from the Actions panel menu. Locate and select the action set file, and then click Load (Photoshop) or Open (Illustrator).
 - (Photoshop only) Select an action set from the bottom of the Actions panel menu.

Photoshop action set files have the extension .atn; Illustrator action set files have the extension .aia.

Restore actions to the default set

- 1 Choose Reset Actions from the Actions panel menu.
- 2 Click OK to replace the current actions in the Actions panel with the default set, or click Append to add the set of default actions to the current actions in the Actions panel.

Organize action sets

To help you organize your actions, you can create sets of actions and save the sets to disk. You can organize sets of actions for different types of work—such as print publishing and online publishing—and transfer sets to other computers.

- To create a new set of actions, click the Create New Set button  in the Actions panel or choose New Set from the panel menu. Then enter the name of the set, and click OK.

***Note:** If you plan to create a new action and group it in a new set, make sure you create the set first. Then, the new set will appear in the set popup menu when you create your new action.*

- To move an action to a different set, drag the action to that set. When the highlighted line appears in the desired position, release the mouse button.
- To rename a set of actions, double-click the name of the set in the Actions panel or choose Set Options from the Actions panel menu. Then enter the new name of the set, and click OK.
- To replace all actions in the Actions panel with a new set, choose Replace Actions from the Actions panel menu. Select an actions file, and click Load (Photoshop) or Open (Illustrator).

***Important:** The Replace Actions command replaces all sets of actions in the current document. Before using the command, make sure that you have already saved a copy of your current set of actions using the Save Actions command.*

Play an action on a batch of files

The Batch command lets you play an action on a folder of files and subfolders. You can also use the Batch command to populate a template for data-driven graphics with different sets of data.

- 1 Choose Batch from the Actions panel menu.
- 2 For Play, select the action you want to play.
- 3 For Source, choose the folder on which to play the action, or select Data Sets to play the action on each data set in the current file.

If you select a folder, you can set additional options for playing the action.

- 4 For Destination, specify what you want to do with the processed files. You can leave the files open without saving the changes (None), save and close the file in their current location (Save And Close), or save the files to a different location (Folder).

Depending on the Destination option you select, you can set additional options for saving the files.

- 5 Specify how you want Illustrator to handle errors during the batch process. If you select Log Errors To File, click Save As, and name the error file.
- 6 Click OK.

 *Saving files using the Batch command options always saves the files in the same format as the original files. To create a batch process that saves files in a new format, record the Save As or Save A Copy command, followed by the Close command, as part of your original action. Then choose None for the Destination when setting up the batch process.*

 *To batch-process using multiple actions, create a new action, and record the Batch command for each action you want to use. This technique also lets you process multiple folders in a single batch. To batch-process multiple folders, create aliases within a folder to the other folders you want to process.*

More Help topics

[“Actions panel overview”](#) on page 447

[“Use data sets”](#) on page 458

Batch options

If you select Folder for Source, you can set the following options:

Override Action “Open” Commands Opens the files from the specified folder and ignores any Open commands recorded as part of the original action.

Include All Subdirectories Processes all files and folders within the specified folder.

If the action contains any save or export commands, you can set the following options:

Override Action “Save” Commands Saves the processed files in the specified destination folder and not to a location recorded in the action. Click Choose to specify the destination folder.

Override Action “Export” Commands Exports the processed files to the specified destination folder and not to a location recorded in the action. Click Choose to specify the destination folder.

If you select Data Sets for Source, you can set an option for generating file names when overriding Save and Export commands:

File + Number Generates the filename by taking the original document’s filename, removing any extension, and then appending a three-digit number corresponding to the data set.

File + Data Set Name Generates the filename by taking the original document’s filename, removing any extension, and then appending an underscore and the name of the data set.

Data Set Name Generates the filename by taking the name of the data set.

Scripts

Use a script

When you run a script, your computer performs a sequence of operations. These operations may involve only Illustrator, or they may involve other applications, such as word-processing, spreadsheet, and database-management programs.

Illustrator supports multiple scripting environments (including Microsoft Visual Basic, AppleScript, JavaScript, and ExtendScript). You can use the standard scripts that come with Illustrator, and you can create your own scripts and add them to the Scripts submenu.

For more information about scripting in Illustrator, see the sample scripts and scripting documentation in the Adobe Illustrator CS5/Scripting folder.

Run a script

- ❖ Choose File > Scripts, and choose a script. Alternatively, choose File > Scripts > Other Script, and navigate to a script.

Note: If you edit a script while Illustrator is running, you must save your changes for them to take effect.

Install a script

- ❖ Copy the script to your computer's hard disk.

If you place the script in the Adobe Illustrator CS5 Scripts folder, the script will appear in the File > Scripts submenu.

If you place the script in another location on the hard disk, you can run the script in Illustrator by choosing File > Scripts > Other Script.

Note: If you place a script in the Adobe Illustrator CS5 Scripts folder while Illustrator is running, you must restart Illustrator for the script to appear in the Scripts submenu.

Data-driven graphics

About data-driven graphics

Data-driven graphics make it possible to produce multiple versions of artwork quickly and accurately. Let's say, for example, that you need to produce 500 different web banners based on the same template. Instead of manually populating the template with data (images, text, and so on), data-driven graphics let you use a script referencing a database to generate the web banners for you.

In Illustrator, you can turn any piece of artwork into a template for data-driven graphics. All you need to do is define which objects on the artboard are dynamic (changeable) using *variables*. You use variables to change text strings, linked images, graph data, and the visibility setting of objects in your artwork. In addition, you can create different sets of variable data in order to easily view what your template will look like when it is rendered.

Data-driven graphics are designed for use in collaborative work environments. Following are some examples of how data-driven graphics fit into different job roles:

- If you're a designer, creating a template gives you control over the dynamic elements of your design. When you hand your template over for production, you can be sure that only the variable data will change.
- If you're a developer, you can code variables and data sets directly into an XML file. The designer can then import the variables and data sets into an Illustrator file to create a design based on your specifications.
- If you're responsible for production, you can use scripts within Illustrator or the Batch command. You can also use a dynamic imaging server such as Adobe® Graphics Server to further automate the rendering process.

More Help topics

[“Use data sets”](#) on page 458

[“About variable libraries”](#) on page 459

Variables panel overview



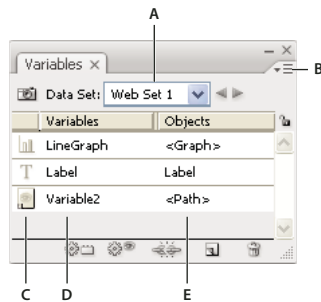

You use the Variables panel (Window > Variables) to work with variables and data sets. The type and name of each variable in the document are listed in the panel. If the variable is bound to an object, then the Objects column displays the name of the bound object as it appears in the Layers panel.



Variables panel

A. Data set B. Panel menu C. Variable type D. Variable name E. Name of bound object

The Variables panel uses the following icons to indicate a variable's type:

- Visibility variable .
- Text String variable **T**.
- Linked File variable .
- Graph Data variable .
- No Type (unbound) variable .

You can sort the rows by clicking items in the header bar: by variable name, object name, or by variable type.

Create variables

You can create four types of variables in Illustrator: Graph Data, Linked File, Text String, and Visibility. A variable's type indicates which object attributes are changeable (dynamic).

Note: The Variable panel menu also provides commands for creating variables.

Create a Visibility variable

- ❖ Select the objects that you want to show or hide and click the Make Visibility Dynamic button  in the Variables panel.

Create a Text String variable

- ❖ Select a type object and click the Make Object Dynamic button  in the Variables panel.

Create a Linked File variable

- ❖ Select a linked file and click the Make Object Dynamic button in the Variables panel.

Create a Graph Data variable

- ❖ Select a graph object and click the Make Object Dynamic button in the Variables panel.

Create a variable without binding it to an object

- ❖ Click the New Variable button  in the Variables panel. To subsequently bind an object to the variable, select the object and the variable, and click the Make Visibility Dynamic button or the Make Object Dynamic button.

Edit variables

You can edit a variable's name or type, unbind a variable, and lock a variable using the Variables panel.

Unbinding a variable breaks the link between the variable and its object. Locking variables prevents you from creating variables, deleting variables, and editing variable options. However, you can bind and unbind objects to locked variables.

More Help topics

[“Variables panel overview”](#) on page 455



Change the name and type of a variable

- ❖ Double-click the variable in the Variables panel. Alternatively, select the variable in the Variables panel, and choose Variable Options from the Variables panel menu.

Unbind a variable

- ❖ Click the Unbind Variable button  in the Variables panel, or choose Unbind Variable from the Variables panel menu.

Lock or unlock all variables in a document

- ❖ Click the Lock/Unlock Variables button  or  in the Variables panel.

Delete variables

Deleting a variable removes it from the Variables panel. If you delete a variable that is bound to an object, the object becomes static (unless the object is also bound to a variable of a different type).

- 1 Select a variable you want to delete.
- 2 Do one of the following:
 - Click the Delete Variable icon  in the Variables panel, or choose Delete Variable from the Variables panel menu.
 - To delete the variable without confirmation, drag it to the Delete Variable icon.

More Help topics

[“Variables panel overview”](#) on page 455

Edit dynamic objects

You change the data associated with a variable by editing the object to which it is bound. For example, if you're working with a Visibility variable, you change the object's state of visibility in the Layers panel. Editing dynamic objects lets you create multiple data sets for use in the template.

- 1 Select a dynamic object on the artboard, or do one of the following to automatically select a dynamic object:
 - Alt-click (Windows) or Option-click (Mac OS) a variable in the Variables panel.
 - Select a variable in the Variables panel, and choose Select Bound Object from the Variables panel menu.
 - To select all dynamic objects, choose Select All Bound Objects from the Variables panel menu.

2 Edit the data associated with the object as follows:

- For text, edit the text string on the artboard.
- For linked files, replace the image using the Links panel or the File > Place command.
- For graphs, edit the data in the Graph Data dialog box.
- For all objects with dynamic visibility, change the state of visibility for the object in the Layers panel.

More Help topics

[“Links panel overview”](#) on page 268

[“Enter graph data”](#) on page 461

[“Layers panel overview”](#) on page 220

[“Variables panel overview”](#) on page 455

Identifying dynamic objects using XML IDs

The Variables panel displays the names of dynamic objects as they appear in the Layers panel. If you save the template in SVG format for use with other Adobe products, these object names must conform to XML naming conventions. For example, XML names must begin with a letter, underscore, or colon, and cannot contain spaces.

Illustrator automatically assigns a valid XML ID to every dynamic object you create. To view, edit, and export object names using XML IDs, choose Edit > Preferences > Units (Windows) or Illustrator > Preferences > Units (Mac OS), and select XML ID.

More Help topics

[“Variables panel overview”](#) on page 455

Use data sets

A *data set* is a collection of variables and associated data. When you create a data set, you capture a snapshot of the dynamic data that is currently displayed on the artboard. You can switch between data sets to upload different data into your template.

The name of the current data set is displayed at the top of the Variables panel. If you change the value of a variable so that the artboard no longer reflects the data stored in the set, the name of the data set is displayed in italic type. You can then create a new data set, or you can update the data set to overwrite the saved data with the new data.

More Help topics

[“About data-driven graphics”](#) on page 455

[“Play an action on a batch of files”](#) on page 453

[“Variables panel overview”](#) on page 455

Create a new data set

- ❖ Click the Capture Data Set button  in the Variables panel. Alternatively, choose Capture Data Set from the Variables panel menu.

Switch between data sets

- ❖ Select a data set from the Data Set list in the Variables panel. Alternatively, click the Previous Data Set button ◀ or the Next Data Set button ▶.

Apply the data on the artboard to the current data set

- ❖ Choose Update Data Set from the Variables panel menu.

Rename a data set

- ❖ Edit the text directly in the Data Set text box. Alternatively, double-click the words *Data Set:* (to the left of the Data Set text box), enter a new name, and click OK.

Delete a data set

- ❖ Choose Delete Data Set from the Variables panel menu.

About variable libraries

In a collaborative environment, coordination between team members is essential to the success of a project. For example, in a company that creates websites, the web designer is responsible for the look and feel of the site, while the web developer is responsible for the underlying code and scripting. If the designer changes the layout of the web page, those changes must be communicated to the developer. Likewise, if the developer needs to add functionality to the web page, the design may need to be updated.

Variable libraries enable designers and developers to coordinate their work through an XML file. For example, a designer can create a template for business cards in Illustrator and export variable data as an XML file. The developer can then use the XML file to link variables and data sets to a database and write a script to render the final artwork. This workflow can also be reversed, where the developer codes the variable and data set names in an XML file, and the designer imports the variable libraries into an Illustrator document.

To import variables into Illustrator from an XML file, choose Load Variable Library from the Variables panel menu.

To export variables from Illustrator to an XML file, choose Save Variable Library from the Variables panel menu.

More Help topics

[“About data-driven graphics”](#) on page 455

[“Use data sets”](#) on page 458

[“Variables panel overview”](#) on page 455

Save a template for data-driven graphics

When you define variables in an Illustrator document, you are creating a template for data-driven graphics. You can save the template in SVG format for use with other Adobe products, such as Adobe® Graphics Server. For example, a developer working with Adobe Graphics Server can bind the variables in the SVG file directly to a database or another data source.

- 1 Choose File > Save As, enter a file name, select SVG as the file format, and click Save.
- 2 Click More Options, and select Include Adobe Graphics Server Data. This option includes all information needed for variable substitution in the SVG file.
- 3 Click OK.

Chapter 15: Graphs

Creating graphs

Graphs let you communicate statistical information in a visual way. In Adobe Illustrator, you can create nine different types of graphs and customize them to suit your needs. Click and hold the graph tool in the Tools panel to see all different types of graphs you can create.

Create a graph

- 1 Select a graph tool.

The tool you use initially determines the type of graph Illustrator generates; however, you can easily change the type of graph later on.

- 2 Define the dimensions of the graph in any of the following ways:

- Drag diagonally from the corner where you want the graph to begin to the opposite corner. Alt-drag (Windows) or Option-drag (Mac OS) to draw the graph from its center. Hold down Shift to constrain the graph to a square.
- Click where you want to create the graph. Enter a width and height for the graph, and click OK.

Note: The dimensions you define are for the main body of the graph and do not encompass the graph's labels and legend.

- 3 Enter data for the graph in the Graph Data window.

Important: Graph data must be arranged in a specific order, which varies by graph type. Before you start to enter data, be sure to read about how to organize labels and data sets in the worksheet.

- 4 Click the Apply button , or press the Enter key on the numeric keypad to create the graph.

The Graph Data window stays open until you close it. This allows you to easily switch between editing graph data and working on the artboard.

More Help topics

[“Graph tool gallery”](#) on page 23

[“Enter graph data”](#) on page 461

[“Formatting and customizing graphs”](#) on page 464

Adjust column width or decimal precision

Adjusting the column width has no effect on the width of columns in the graph; it only lets you view more or fewer digits in a column.

With the default value of 2 decimals, the number 4 entered in a cell appears in the Graph Data window box as 4.00, and the number 1.55823 entered in a cell displays as 1.56.

Adjust the width of columns

- ❖ Do one of the following:

- Click the Cell Style button , and enter a value between 0 and 20 in the Column Width text box.

- Position the pointer at the edge of the column you want to adjust. The pointer changes to a double arrow . Then drag the handle to the desired position.

Adjust the decimal precision for cells

- ❖ Click the Cell Style button, and enter a value between 0 and 10 in the Number of Decimals text box.

Enter graph data

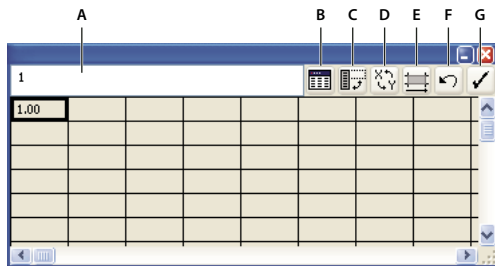

You use the Graph Data window to enter the data for your graph. The Graph Data window appears automatically when you use a graph tool and stays open until you close it.



Graph data window

A. Entry text box B. Import data C. Transpose row/column D. Switch x/y E. Cell style F. Revert G. Apply

- 1 Display the Graph Data window for an existing graph: select the entire graph with the Selection tool, and then choose Object > Graph > Data.
- 2 Enter data in any of the following ways:
 - Select a cell in the worksheet, and enter the data in the text box at the top of the window. Press Tab to input the data and select the next cell in the same row; press Enter or Return to input the data and select the next cell in the same column; use the arrow keys to move from cell to cell; or simply click another cell to select it.
 - Copy data from a spreadsheet application such as Lotus® 1-2-3 or Microsoft Excel. In the Graph Data window, click the cell that will be the upper-left cell of the data you paste, and choose Edit > Paste.
 - Use a word-processing application to create a text file in which the data for each cell is separated by a tab, and the data for each row is separated by a paragraph return. The data can only contain decimal points or decimal commas; otherwise, the data is not plotted. (For example, enter **732000**, not **732,000**.) In the Graph Data window, click the cell that will be the upper-left cell of the data you import, click the Import Data button , and select the text file.

Note: If you accidentally enter graph data backward (that is, in rows instead of columns, or vice versa), click the Transpose button  to switch the columns and rows of data. To switch the x and y axes of scatter graphs, click the Switch X/Y button .

- 3 Click the Apply button  or press the Enter key on the numeric keypad to regenerate the graph.

Use graph labels and data sets

Labels are words or numbers that describe two things: the sets of data you want to compare, and the categories across which you want to compare them. For column, stacked column, bar, stacked bar, line, area, and radar graphs, you enter labels in the worksheet as follows:

Graphs

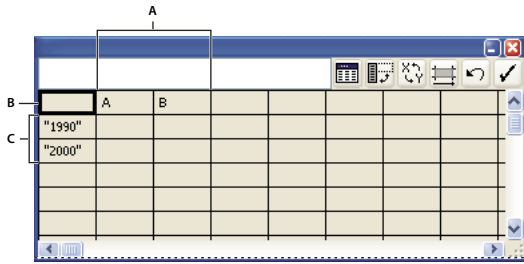

Labels in Graph Data window
 A. Data set labels B. Blank cell C. Category labels

Enter labels

❖ For column, stacked column, bar, stacked bar, line, area, and radar graphs, enter labels in the worksheet as follows:

- If you want Illustrator to generate a legend for the graph, delete the contents of the upper-left cell and leave the cell blank.
- Enter labels for the different sets of data in the top row of cells. These labels will appear in the legend. If you don't want Illustrator to generate a legend, don't enter data-set labels.
- Enter labels for the categories in the left column of cells. Categories are often units of time, such as days, months, or years. These labels appear along either the horizontal axis or vertical axis of the graph, with the exception of radar graphs, for which each label results in a separate axis.
- To create labels consisting only of numbers, enclose the numbers in straight quotation marks. For example, enter "1996" to use the year 1996 as a label.
- To create line breaks in labels, use the vertical bar key to separate lines. For example, type **Total|subscriptions|1996** to produce the following graph label:

Total
 subscriptions
 1996

Enter data sets for scatter graphs

A scatter graph differs from the other kinds of graphs in that both axes measure values; there are no categories.

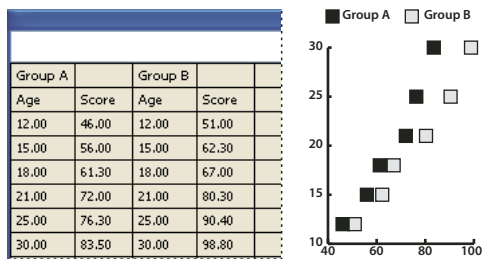

Scatter graph data

- Enter data-set labels in every other cell along the top row of the worksheet, starting with the first cell. These labels will appear in the legend.
- Enter y-axis data in the first column and x-axis data in the second column.

Enter data sets for pie graphs

You organize data sets for pie graphs similarly to other graphs. However, each row of data in the worksheet generates a separate graph.

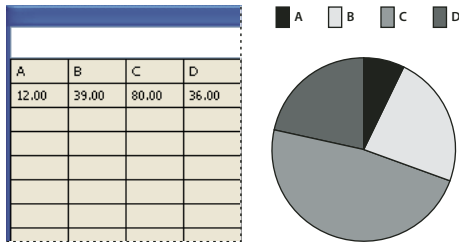

Pie graph data

- Enter data-set labels as for column, stacked column, bar, stacked bar, line, area, and radar graphs. Enter category labels if you want to generate graph names.
- To create a single pie graph, plot only one row of data, either all positive or all negative values.
- To create multiple pie graphs, plot additional rows of data, either all positive or all negative values. By default, the size of the individual pie graphs is proportional to the total of each graph's data.

Enter data sets for column, bar, line, area, and radar graphs

After you enter the labels for your graph, you're ready to enter each set of data under the appropriate column.

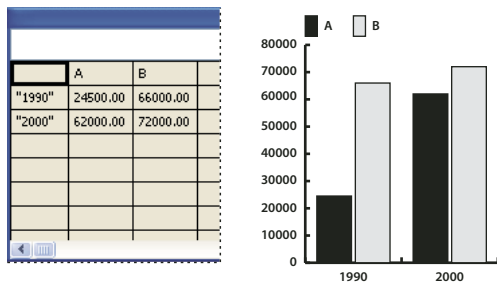

Column graph data

Column, stacked column, bar, stacked bar graphs The height of the column or length of the bar corresponds to the amount being compared. For column or bar graphs, you can combine positive and negative values; negative values appear as columns extending below the horizontal axis. For stacked column graphs, numbers must be all positive or all negative.

Line graphs Each column of data corresponds to one line in the line graph. You can combine positive and negative values in a line graph.

Area graphs Values must be all positive or all negative. Each row of data entered corresponds to a filled area on the area graph. Area graphs add each column's values to the previous column's totals. Therefore, even if area graphs and line graphs contain the same data, they appear substantially different.

Radar graphs Each number is plotted on an axis and connected to the others in the same axis to create a "web." You can combine positive and negative values in a radar graph.

Formatting graphs

Formatting and customizing graphs

Graphs can be formatted in a variety of ways. For example, you can change the appearance and position of the graph's axes, add drop shadows, move the legend, and combine different graph types. You can view the formatting options for a graph by selecting a graph with the Selection tool and choosing Object > Graph > Type.

You can also manually customize your graph in numerous ways. You can change the colors of shading; change the typeface and type style; move, reflect, shear, rotate, or scale any or all parts of the graph; and customize column and marker designs. You can apply transparency, gradients, blends, brush strokes, graphic styles, and other effects to graphs. You should always apply these types of changes last, because regenerating the graph will remove them.



To get ideas for how you can customize graphs, see the examples in the Cool Extras/Sample Files/Graph Designs folder inside the Illustrator application folder.

Keep in mind that a graph is a grouped object that is related to its data. Never ungroup the graph; if you do, you cannot change the graph. To edit a graph, select the parts you want to edit without ungrouping the graph, using either the Direct Selection tool or the Group Selection tool.

It is also important to understand how elements of a graph are related. The entire graph with its legends is one group. All the sets of data are a subgroup of the graph; in turn, each set of data with its legend box is a subgroup of all the sets of data. Each value is a subgroup of its set of data, and so on. Never ungroup or regroup objects that are within the graph.

More Help topics

[“About graph designs”](#) on page 468

Change the graph type

- 1 Select a graph with the Selection tool.
- 2 Choose Object > Graph > Type, or double-click the graph tool in the Tools panel.
- 3 In the Graph Type dialog box, click the button that corresponds to the desired graph type, and click OK.

***Note:** Once graph objects are painted with gradients, changing graph types can cause unexpected results. To prevent undesirable results, either do not apply gradients until the graph is finished, or use the Direct Selection tool to select gradient-painted objects and paint those objects with a process color; then reapply the original gradients.*

Format a graph's axes

With the exception of pie graphs, all graphs have a *value axis* which displays the unit of measurement for the graph. You can choose to display the value axis on one side or both sides of the graph. Bar, stacked bar, column, stacked column, line, and area graphs also have a *category axis* which defines the categories of data in the graph.

You can control how many tick marks appear on each axis, change the length of tick marks, and add a prefix and suffix to numbers on the axis.

- 1 Select the graph with the Selection tool.
- 2 Choose Object > Graph > Type, or double-click the graph tool in the Tools panel.
- 3 To change the position of the value axis, select an option from the Value Axis menu.

- 4 To format tick marks and labels, select an axis from the pop-up menu at the top of the dialog box, and set the following options:

Tick Values Determines the placement of tick marks on value axes, left axes, right axes, bottom axes, or top axes. Select **Override Calculated Values** to manually calculate the placement of tick marks. Either accept the values set when you created the graph or enter a minimum value, a maximum value, and the number of divisions between labels.

Tick Marks Determines the length of tick marks and number of tick marks per division. For category axes, select **Draw Tick Marks Between Labels** to draw tick marks on either side of the labels or columns, or deselect the option to center tick marks over the labels or columns.

Add Labels Specifies a prefix and suffix for numbers on value axes, left axes, right axes, bottom axes, or top axes. For example, you can add a dollar sign or percent sign to axis numbers.

Assign different scales to the value axes

If your graph has a value axis on both sides, you can assign a different set of data to each axis. This causes Illustrator to generate a different scale for each axis. This technique is especially useful when you combine different graph types in the same graph.

- 1 Select the Group Selection tool .
- 2 Click the legend for the data set you want to assign to the axis.
- 3 Without moving the Group Selection tool pointer from the legend, click again. All of the columns grouped with the legend are selected.
- 4 Choose **Object > Graph > Type**, or double-click the graph tool in the Tools panel.
- 5 From the Value Axis pop-up menu, select the axis to which you want to assign the data.
- 6 Click **OK**.

More Help topics

[“Selection tool gallery”](#) on page 18

Format columns, bars, and lines

For column, stacked column, bar, and stacked bar graphs, you can adjust the amount of space between each column or bar in the graph. You can also adjust the amount of space between the categories, or *clusters*, of data in the graph. For line, scatter, and radar graphs, you can adjust the appearance of lines and data points.

- 1 Select the graph with the Selection tool.
- 2 Choose **Object > Graph > Type**, or double-click the graph tool in the Tools panel.
- 3 To adjust the space between columns and bars in a column, stacked column, bar, or stacked bar graph, enter a value between 1% and 1000% in the Column Width, Bar Width, or Cluster Width text box.

A value greater than 100% causes the columns, bars, or clusters to overlap one another. A value less than 100% leaves space between the columns, bars, or clusters. A value of 100% moves the columns, bars, or clusters flush against each other.

- 4 To adjust lines and data points in line, scatter, and radar graphs, set the **Mark Data Points**, **Connect Data Points**, **Edge-to-Edge Lines**, and **Draw Filled Lines** options.
- 5 To change how columns, bars, and lines overlap, set the **First Row In Front** and **First Column In Front** options.

Note: Always select First Column In Front for area graphs; if you do not, some areas may not appear.

General graph options

You can access general graph options by selecting the graph with the Selection tool and double-clicking the graph tool in the Tools panel.

Value Axis Determines where the value axis (the axis that displays the unit of measurement) appears.

Add Drop Shadow Applies drop shadows behind the columns, bars, or lines in a graph, and to entire pie graphs.

Add Legend Across Top Displays the legend horizontally across the top of the graph instead of to the right of the graph.

First Row In Front Controls how the categories, or clusters, of data in a graph overlap when the Cluster Width is greater than 100%. This option is the most useful when working with column and bar graphs.

First Column In Front Places the column, bar, or line that corresponds to the first column of data in the Graph Data window on top. This option also determines which column is on top for column and stacked column graphs with a Column Width greater than 100% and for bar and stacked bar graphs with a Bar Width greater than 100%.

Mark Data Points Places square markers at each data point.

Connect Data Points Draws lines that make it easier to see relationships among data.

Edge-to-Edge Lines Draws lines that extend across the graph, from left to right along the horizontal (x) axis. This option is not available for scatter graphs.

Draw Filled Lines Creates a wider line according to the value you enter in the Line Width text box, and which fills the line with paint according to the specifications for that series of data. This option becomes available when you select Connect Data Points.

Add drop shadows

You can apply drop shadows behind the columns, bars, or lines in a graph, and to entire pie graphs.

- 1 Select a graph with the Selection tool.
- 2 Choose Object > Graph > Type, or double-click the graph tool in the Tools panel.
- 3 In the Graph Type dialog box, select Add Drop Shadow, and click OK.

Change the position of a legend

By default, the legend is displayed to the right of the graph. However, you can choose to display it horizontally across the top of the graph.

- 1 Select a graph with the Selection tool.
- 2 Choose Object > Graph > Type, or double-click the graph tool in the Tools panel.
- 3 In the Graph Type dialog box, select Add Legend Across Top, and click OK.

Format pie graphs

You can change the placement of the legend and how wedges are sorted in pie graphs. You can also specify how you want to display multiple pie graphs.

- 1 Select the graph with the Selection tool.
- 2 Choose Object > Graph > Type, or double-click the graph tool in the Tools panel.

Graphs

3 Do any of the following:

- To change the placement of the legend, select an option for Legend.
- To specify how multiple pie graphs are displayed, select an option for Position.
- To specify how wedges are sorted, select an option for Sort.

 Percentages and legends are painted black by default. If a pie wedge with a dark background obscures a legend, repaint the dark background. Use the Group Selection tool to select the dark pie wedges, and paint the wedges using the Color panel or Swatches panel.

Pie graph options

Legend Determines the placement of the legend.

- **Standard Legend** Places column labels outside the graph; this is the default. Use this option when you combine pie graphs with other kinds of graphs.
- **Legends In Wedges** Inserts labels into the corresponding wedges.
- **No Legend** Omits legends entirely.

Position Specifies how multiple pie graphs are displayed.

- **Ratio** Sizes the graphs proportionally.
- **Even** Makes all the pie graphs the same diameter.
- **Stacked** Stacks each pie graph on top of the other, and each graph is sized proportionally to each other.

Sort Specifies how wedges are sorted.

- **All** Sorts the wedges of the selected pie graphs from largest to smallest value proceeding clockwise from the top of the pie graph.
- **First** Sorts the wedges of the selected pie graphs so that the largest value in the first graph will be placed in the first wedge, and the rest will sort from largest to smallest. All other graphs will follow the order of the wedges in the first graph.
- **None** Sorts the wedges of the selected pie graphs in the order in which you entered values proceeding clockwise from the top of the graphs.

Combine different graph types

You can combine different graph types in one graph. For example, you may want one set of data to appear as a column graph and other sets of data to appear as a line graph. You can combine any type of graph with any other, with the exception of scatter graphs. Scatter graphs cannot be combined with any other graph type.

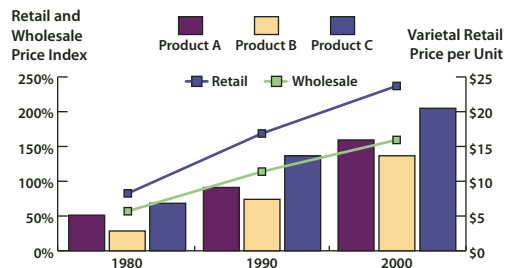

Combining columns and lines in one graph

1 Select the Group Selection tool .

- 2 Click the legend for the data whose graph type you want to change.
- 3 Without moving the Group Selection tool pointer from the legend, click again. All of the columns grouped with the legend are selected.
- 4 Choose Object > Graph > Type, or double-click the graph tool in the Tools panel.
- 5 Select the graph type and options you want.

If a graph uses more than one graph type, you may want one set of data along the right axis and the other set of data along the left axis. In this way, each axis measures different data.

Note: If you use stacked column graphs with other graph types, be sure to use the same axis for all sets of data that are represented by stacked column graphs. If some sets of data use the right axis while others use the left, the column heights may be misleading or may overlap.

Select parts of a graph

- 1 Select the Group Selection tool .
- 2 Click the legend of the columns you want to select.
- 3 Without moving the Group Selection tool pointer from the legend, click again. All of the columns grouped with the legend are selected.

You can also select a group by clicking one of its parts, clicking again to select columns grouped with it, and clicking a third time to select the legend. Each click adds another layer of grouped objects to the selection, beginning with the next group up in the hierarchy. You can click as many times as the number of groups to add to a selection.

- 4 To deselect part of a selected group, select the Direct Selection tool , and Shift-click the object.

Format the text in a graph

Illustrator uses a default font and font size when generating text for the graph's labels and legend. However, you can easily change the formatting of type to add visual interest to your graph.

- 1 Select the Group Selection tool .
- 2 Click once to select the baseline of the type you want to change; click twice to select all of the type.
- 3 Change the type attributes as desired.

Adding pictures and symbols to graphs

About graph designs

You use *graph designs* to add illustrations to columns and markers. Graph designs can be simple drawings, logos, or other symbols representing values in a graph; they can also be complex objects that contain patterns and guide objects. Illustrator comes with a variety of preset graph designs. In addition, you can create new graph designs and store them in the Graph Design dialog box.

You can apply graph design to columns in several ways:

Vertically scaled design Is stretched or compressed vertically. Its width does not change.

Uniformly scaled design Is scaled both vertically and horizontally. The horizontal spacing of the designs is not adjusted for the different widths.

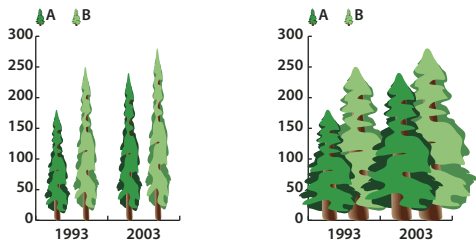

Vertically scaled graph design compared to uniformly scaled graph design

Repeating design Stacks a design to fill the columns. You can specify the value that each design represents, as well as whether you want to chop or scale designs that represent fractions.

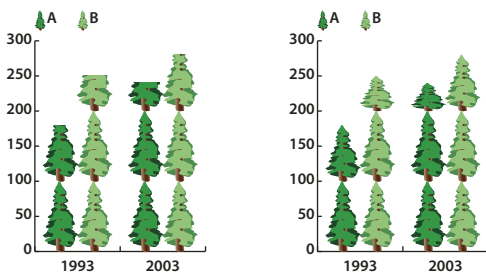

Repeating graph with chopped design compared to repeating graph with scaled design

Sliding design Is similar to a vertically scaled design, except that you can specify where in the design to stretch or compress it. For example, if you were using a person to represent data, you might stretch or compress only the body, but not the head. Using the Vertically Scaled option would scale the entire person.

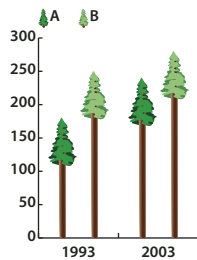

Sliding graph design

Import a column or marker design

Illustrator comes with a variety of preset designs that you can use in your graphs. You can also transfer the graph designs you create between documents.

- 1 Choose Window > Swatch Libraries > Other Library.
- 2 Do one of the following:
 - To import preset graph designs, navigate to the Cool Extras/Sample Files/Graph Designs folder inside the Illustrator application folder. Then select a graph designs file, and click Open.
 - To import graph designs from another document, select the document, and click Open.

Initially, all that appears is a new panel with colors, gradients, and patterns from the imported file. However, the imported graph designs will be available when you open the Graph Column or Graph Marker dialog box.

Create a column design

1 Create a rectangle as the backmost object in the design. The rectangle represents the boundary of the graph design.

 *Copy and paste the smallest column in your graph to use it as the bounding rectangle for your design.*

2 Paint the rectangle as desired, or fill and stroke it with None so that it is invisible.

3 Create the design using any of the drawing tools, or position an existing design in front of the rectangle.

4 Using the Selection tool , select the entire design, including the rectangle.

5 Choose Object > Group to group the design.

6 Choose Object > Graph > Design.

7 Click New Design. A preview of the selected design appears. Only the portion of the design that fits inside the backmost rectangle is visible, but the whole design appears when used in the graph.

8 Click Rename to name the design.

 *Creating a graph design is similar to creating a pattern.*

More Help topics

[“About patterns”](#) on page 195

Create a sliding column design



1 Create a rectangle as the backmost object in the design. This rectangle is the boundary for the graph design.

2 Create the design using one of the drawing tools, or place an existing design in front of the rectangle.

3 Use the Pen tool  to draw a horizontal line to define where the design is to be stretched or compressed.

4 Select all parts of the design, including the horizontal line.

5 Choose Object > Group to group the design.

6 Use the Direct Selection tool  or Group Selection tool  to select the horizontal line. Be sure to select only the horizontal line.

7 Choose View > Guides > Make Guides.

8 Choose View > Guides > Lock Guides to remove the check mark next to Lock so you can unlock the guides. Move the design around to make sure that the guide moves with the design.

9 Use the Selection tool  to select the whole design.

10 Choose Object > Graph > Design.

11 Click New Design. A preview of the selected design appears.

12 Click Rename to name the design.

Add totals to a column design

1 Create the column design.

2 Select the Type tool . Position the pointer at a point where you want the value to appear, near or in the rectangle that defines the design.

For example, you can place the value in, above, below, to the left, or to the right of the design.

- 3 Click and type a percent sign (%) followed by two digits from 0 to 9. The digits control how the data is displayed. The first digit determines how many places appear before the decimal point. For example, if your total was 122, a digit of 3 would display 122. If you enter 0 for the first digit, the program adds the number of places necessary for the value. The second digit determines how many places appear after the decimal point. Zeros are added as necessary, and values are rounded up or down as necessary. You can vary these numbers, depending on how many digits you need.
- 4 To change the type attributes, choose Window > Type > Character, specify the attributes you want, and close the panel.
- 5 To align the decimal points, choose Window > Type > Paragraph and click the Align Text Right button.
- 6 Using the Selection tool , select the entire design, including the rectangle and any type.
- 7 Choose Object > Group to group the design.
- 8 Choose Object > Graph > Design.
- 9 Click New Design. You see a preview of the selected design.
- 10 Click Rename to name the design.

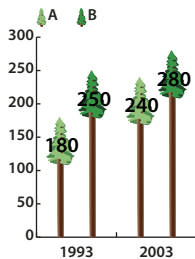

Sliding graph design with column totals

Create a marker design

- 1 Select and copy a marker rectangle from the graph, and paste it where you're going to create your design. This will be the backmost object in your graph design and will establish the size of the marker.
- 2 Make the marker artwork the size you want it to be in the graph, even if it's larger than the marker rectangle you copied.
- 3 Once you've got the marker design the way you want it, select the design, choose Object > Graph > Design, and click New Design.
- 4 Click Rename to name the design.

Apply a column design to a graph

- 1 Create or import the column design.
- 2 Use the Group Selection tool  to select the columns or bars you want to fill with the design, or select the entire graph.
- 3 Choose Object > Graph > Column.
- 4 Select a column design type.

If you choose the Repeating Column Type, enter a value in the Each Design Represents text box. Also select whether to chop or scale any fractions of the design from the For Fractions pop-up menu. Chop Design cuts off a fraction of the top design as necessary; Scale Design scales the last design to fit in the column.

- 5 Select the design you want to use. A preview of the selected design appears.
- 6 Click OK.

Apply a marker design to a line or scatter graph

- 1 Create or import the column design.
- 2 Use the Group Selection tool  to select the markers and the legends in the graph that you want to replace with a design. Do not select any lines.
- 3 Choose Object > Graph > Marker. Select a design, and click OK.

The design is scaled so that the backmost rectangle in the design is the same size as the default square marker on the line or scatter graph.

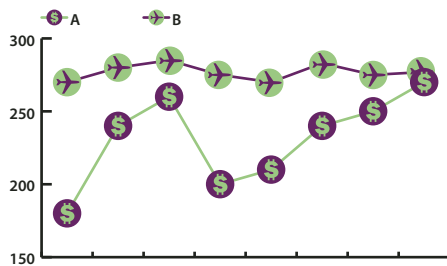

Line graph with marker designs

Reuse a graph design

You can reuse a graph design that you created and edit it to make a new design. If you have the original artwork, you can alter it and then rename the design using the Graph Design dialog box.

If you don't have the original artwork defined as a graph design, you can retrieve the original by pasting the graph design into your artwork.

- 1 Choose Select > Deselect to deselect all of the artwork.
- 2 Choose Object > Graph > Design.
- 3 Select the graph design that you want to paste into your artwork, and click Paste Design.
- 4 Click OK. The graph design is pasted into your artwork. You can now edit it and define it as a new graph design.

Chapter 16: Keyboard shortcuts

Customizing keyboard shortcuts

Keyboard shortcuts make you more productive in Illustrator. You can use the default shortcuts included with Illustrator, or add and customize shortcuts to suit your needs.

Customize keyboard shortcuts

Illustrator lets you view a list of all shortcuts, and edit or create shortcuts. The Keyboard Shortcuts dialog box serves as a shortcut editor, and includes all commands that support shortcuts, some of which aren't addressed in the default shortcut set.

You can define your own sets of shortcuts, change individual shortcuts within a set, and switch between sets of shortcuts. For example, you can create separate sets for different workspaces chosen from the Window > Workspace menu.

If you have previously saved a set of keyboard shortcuts other than the default, then the keyboard shortcuts are stored in a .kys file in Illustrator's preferences folder. You can copy this file into the same location (in Ai's preferences folder) in the new computer. You can then choose this set from Illustrator's Keyboard Shortcuts dialog.

You can use the same .kys file across platforms as long as the modified shortcuts are valid for the platforms.

Following are the locations where the custom Illustrator keyboard shortcuts are saved by default:

Mac OS:

```
user/Library/Preferences/Illustrator CS5 Settings/[language]/mycustomshortcut.kys
```

Windows Vista and Windows 7

```
<rootdir>\Users\[user name]\AppData\Roaming\Adobe\Adobe Illustrator CS5  
Settings\[language]\mycustomshortcut.kys
```

Win XP

```
<rootdir>\Document and Settings\<<user name>\Application Data\Adobe\Adobe Illustrator CS5  
Settings\[language]\mycustomshortcut.kys
```

 *In addition to using keyboard shortcuts, you can access many commands using context-sensitive menus. Context-sensitive menus display commands that are relevant to the active tool, selection, or panel. To display a context-sensitive menu, right-click (Windows) or Control-click (Mac OS) in the document window or panel.*

- 1 Choose Edit > Keyboard Shortcuts.
- 2 Choose a set of shortcuts from the Set menu at the top of the Keyboard Shortcuts dialog box.
- 3 Choose a shortcut type (Menu Commands or Tools) from the menu above the shortcut display.
- 4 Do any of the following:
 - To activate the set of shortcuts, click OK.
 - To change a shortcut, click in the Shortcut column of the scroll list and type a new shortcut. If you enter a shortcut that is already assigned to another command or tool, an alert appears at the bottom of the dialog box. Click Undo to undo the change, or click Go To to go to the other command or tool and assign it a new shortcut. In the Symbol column, type the symbol that will appear in the menu or tool tip for the command or tool. You can use any of the characters that are allowed in the Shortcut column.

Note: Mac OS does not allow you to assign Command+Option+8 as a menu shortcut.

- To save changes to the current set of shortcuts, click OK. (You can't save changes to the set named Illustrator Defaults.)
- To save a new set of shortcuts, click Save. Enter a name for the new set, and click OK. The new key set will appear in the pop-up menu under the new name.
- To delete the set of shortcuts, click Delete. (You can't delete the set named Illustrator Defaults.)
- To export the displayed set of shortcuts into a text file, click Export Text. In the Save Key Set File As dialog box, enter a filename for the current key set that you are saving, and click Save. You can use this text file to print out a copy of your keyboard shortcuts.

Default keyboard shortcuts

Keys for selecting tools

Result	Windows	Mac OS
Artboard tool	Shift + O	Shift + O
Selection tool	V	V
Direct Selection tool	A	A
Magic Wand tool	Y	Y
Lasso tool	Q	Q
Pen tool	P	P
Blob Brush tool	Shift + B	Shift + B
Add Anchor Point tool	+ (plus)	+ (plus)
Delete Anchor Point tool	- (minus)	- (minus)
Convert Anchor Point tool	Shift + C	Shift + C
Type tool	T	T
Line Segment tool	\ (backslash)	\ (backslash)
Rectangle tool	M	M
Ellipse tool	L	L
Paintbrush tool	B	B
Pencil tool	N	N
Rotate tool	R	R
Reflect tool	O	O
Scale tool	S	S
Warp tool	Shift + R	Shift + R
Width Tool	Shift+W	Shift+W
Free Transform tool	E	E

Result	Windows	Mac OS
Shape Builder Tool	Shift+M	Shift+M
Perspective Grid Tool	Shift+P	Shift+P
Perspective Selection Tool	Shift+V	Shift+V
Symbol Sprayer tool	Shift + S	Shift + S
Column Graph tool	J	J
Mesh tool	U	U
Gradient tool	G	G
Eyedropper tool	I	I
Blend tool	W	W
Live Paint Bucket tool	K	K
Live Paint Selection tool	Shift + L	Shift + L
Slice tool	Shift + K	Shift + K
Eraser tool	Shift + E	Shift + E
Scissors tool	C	C
Hand tool	H	H
Zoom tool	Z	Z
Switch to Smooth tool while using Blob Brush tool	Press Alt	Press Option

Keys for viewing artwork

This is not a complete list of keyboard shortcuts. This table lists only those shortcuts that are not displayed in menu commands or tool tips.

Result	Windows	Mac OS
Toggle between screen modes: Normal Screen Mode, Full Screen Mode with Menu Bar, Full Screen Mode	F	F
Fit imageable area in window	Double-click Hand tool	Double-click Hand tool
Magnify 100%	Double-click Zoom tool	Double-click Zoom tool
Switch to Hand tool (when not in text-edit mode)	Spacebar	Spacebar
Switch to Zoom tool in magnify mode	Ctrl + Spacebar	Spacebar + Command
Switch to Zoom tool in reduce mode	Ctrl + Alt + Spacebar	Spacebar + Command + Option
Move Zoom marquee while dragging with the Zoom tool	Spacebar	Spacebar
Hide unselected artwork	Control + Alt + Shift + 3	Command + Option + Shift + 3
Convert between horizontal and vertical guide	Alt-drag guide	Option-drag guide

Result	Windows	Mac OS
Release guide	Ctrl + Shift-double-click guide	Command + Shift-double-click guide
Show/Hide artboards	Ctrl + Shift + H	Command + Shift + H
Show/Hide artboard rulers	Ctrl + Alt + R	Command + Option + R
View all artboards in window	Ctrl + Alt + 0 (zero)	Command + Option + 0 (zero)
Paste in place on the active artboard	Ctrl+Shift+V	Command+Shift+V
Exit Artboard tool mode	Esc	Esc
Create artboard inside another artboard	Shift-drag	Shift-drag
Select multiple artboards in the Artboards panel	Ctrl+click	Command+click
Navigate to next document	Ctrl + F6	Command+F6
Navigate to previous document	Ctrl + Shift + F6	Command+Shift+F6
Navigate to next document group	Ctrl + Alt + F6	Command+Option+F6
Navigate to previous document group	Ctrl + Alt + Shift + F6	Command+Option+Shift+F6
Exit Full Screen mode	Esc	Esc
Save multiple artboards to Illustrator CS3 or earlier format	Alt + v	

Keys for drawing

This is not a complete list of keyboard shortcuts. This table lists only those shortcuts that are not displayed in menu commands or tool tips.

Result	Windows	Mac OS
Constrain a shape's proportions or orientation to: <ul style="list-style-type: none"> • equal height and width for rectangles, rounded rectangles, ellipses, and grids • Increments of 45° for line and arc segments • Original orientation for polygons, stars, and flares 	Shift-drag	Shift-drag
Move a shape while drawing it	spacebar-drag	spacebar-drag
Draw from the center of a shape (except for polygons, stars, and flares)	Alt-drag	Option-drag
Increase or decrease polygon sides, star points, arc angle, spiral winds, or flare rays	Start dragging, then press the Up Arrow or Down Arrow	Start dragging, then press the Up Arrow or Down Arrow
Keep the inner radius of a star constant	Start dragging, then hold down Ctrl	Start dragging, then hold down Command
Keep the sides of a star straight	Alt-drag	Option-drag
Switch between an open and closed arc	Start dragging, then hold down C	Start dragging, then hold down C
Flip an arc, keeping the reference point constant	Start dragging, then hold down F	Start dragging, then hold down SF

Result	Windows	Mac OS
Add or subtract winds from a spiral while increasing the length of the spiral	Start dragging, then Alt-drag	Start dragging then Option-drag
Change the decay rate of a spiral	Start dragging then Ctrl-drag	Start dragging then Command-drag
Add or remove horizontal lines from a rectangular grid or concentric lines from a polar grid	Start dragging, then press the Up Arrow or Down Arrow	Start dragging, then press the Up Arrow or Down Arrow
Add or remove vertical lines from a rectangular grid or radial lines from a polar grid	Start dragging, then press the Right Arrow or Left Arrow	Start dragging, then press the Right Arrow or Left Arrow
Decrease the skew value for horizontal dividers in a rectangular grid or radial dividers in a polar grid by 10%	Start dragging, then press F	Start dragging, then press F
Increase the skew value for horizontal dividers in a rectangular grid or radial dividers in a polar grid by 10%	Start dragging, then press V	Start dragging, then press V
Decrease the skew value for vertical dividers in a rectangular grid or concentric dividers in a polar grid by 10%	Start dragging, then press X	Start dragging, then press X
Increase the skew value for vertical dividers in a rectangular grid or concentric dividers in a polar grid by 10%	Start dragging, then press C	Start dragging, then press C
Create and expand a Live Trace object in one step	Alt-click Live Trace in the Control panel, or hold down Alt and select a tracing preset.	Option-click Live Trace in the Control panel, or hold down Option and select a tracing preset.
Increase size of Blob Brush] (right square bracket)] (right square bracket)
Decrease size of Blob Brush	[(left square bracket)	[(left square bracket)
Constrain Blob Brush path horizontally or vertically	Shift	Shift
Switch through drawing modes	Shift+D	Shift+D
Join two or more paths	Select the paths, then press Ctrl+J	Select the paths, then press Command+J
Create corner or smooth join	Select the paths, then press Shift+Ctrl+Alt+j	Select the anchor point, then press Shift+Command+Option+j

Keys for drawing in perspective

This is not a complete list of keyboard shortcuts. This table lists only those shortcuts that are not displayed in menu commands or tool tips.

Results	Windows	Mac OS
Perspective Grid Tool	Shift+P	Shift+P
Perspective Selection Tool	Shift+V	Shift+V
Perspective Grid	Ctrl+Shift+l	Command+Shift+l
Moving objects perpendicularly	Press the number 5 key, then click and drag the object	Press the number 5 key, then click and drag the object

Results	Windows	Mac OS
Switching perspective planes	Use the Perspective Selection tool and then press 1 for left grid, 2 for horizontal grid, 3 for right grid, or 4 for no active grid	Use the Perspective Selection tool and then press 1 for left grid, 2 for horizontal grid, 3 for right grid, or 4 for no active grid
Copying objects in perspective	Ctrl+Alt+drag	Command+Alt+drag
Repeat transforming objects in perspective	Ctrl+D	Command+D
Switching between drawing modes	Shift+D	Shift+D

Keys for selecting

This is not a complete list of keyboard shortcuts. This table lists only those shortcuts that are not displayed in menu commands or tool tips.

Result	Windows	Mac OS
Switch to last-used selection tool (Selection tool, Direct Selection tool, or Group Selection tool)	Ctrl	Command
Switch between Direct Selection tool and Group Selection tool	Alt	Option
Add to a selection with Selection tool, Direct Selection tool, Group Selection tool, Live Paint Selection tool, or Magic Wand tool	Shift-click	Shift-click
Subtract a selection with Selection tool, Direct Selection tool, Group Selection tool, or Live Paint Selection tool	Shift-click	Shift-click
Subtract from selection with Magic Wand tool	Alt-click	Option-click
Add to selection with Lasso tool	Shift-drag	Shift-drag
Subtract from selection with Lasso tool	Alt-drag	Option-drag
Change pointer to cross hair for Lasso tool	Caps Lock	Caps Lock
Select artwork in active artboard	Ctrl + Alt + A	Command + Option + A
Create crop marks around selected object	Alt + c + o	
Select behind an object	Press Ctrl+click twice	Press Command+click twice
Select behind in isolation mode	Ctrl+click twice	Command+click twice

Keys for moving selections

This is not a complete list of keyboard shortcuts. This table lists only those shortcuts that are not displayed in menu commands or tool tips.

Result	Windows	Mac OS
Move selection in user-defined increments	Right Arrow, Left Arrow, Up Arrow, or Down Arrow	Right Arrow, Left Arrow, Up Arrow, or Down Arrow
Move selection in 10x user-defined increments	Shift + Right Arrow, Left Arrow, Up Arrow, or Down Arrow	Shift + Right Arrow, Left Arrow, Up Arrow, or Down Arrow
Lock all deselected artwork	Ctrl + Alt + Shift + 2	Command + Option + Shift + 2
Constrain movement to 45° angle (except when using Reflect tool)	Hold down Shift	Hold down Shift

 Set keyboard increments in General Preferences

Keys for editing shapes

This is not a complete list of keyboard shortcuts. This table lists only those shortcuts that are not displayed in menu commands or tool tips.

Result	Windows	Mac OS
Switch Pen tool to Convert Anchor Point tool	Alt	Option
Switch between Add Anchor Point tool and Delete Anchor Point tool	Alt	Option
Switch Scissors tool to Add Anchor Point tool	Alt	Option
Switch Pencil tool to Smooth tool	Alt	Option
Move current anchor point while drawing with Pen tool	Spacebar-drag	Spacebar-drag
Cut a straight line with Knife tool	Alt-drag	Option-drag
Cut at 45° or 90° with Knife tool	Shift + Alt-drag	Shift + Option-drag
Use shape mode buttons in Pathfinder panel to create compound paths	Alt + Shape mode	Option + Shape mode
Erase unwanted closed regions created using Shape Builder tool	Alt+click the closed region	Option+click the closed region
Select the Shape Builder tool	Shift+M	Shift+M
Display rectangular marquee to easily merge multiple paths (when using Shape Builder tool)	Shift+click+drag	Shift+click+drag

Keys for painting objects

This is not a complete list of keyboard shortcuts. This table lists only those shortcuts that are not displayed in menu commands or tool tips.

Result	Windows	Mac OS
Toggle between fill and stroke	X	X
Set fill and stroke to default	D	D
Swap fill and stroke	Shift + X	Shift + X
Select gradient fill mode	>	>
Select color fill mode	<	<
Select no stroke/fill mode	/ (forward slash)	/ (forward slash)
Sample color from an image or intermediate color from gradient	Shift + Eyedropper tool	Shift + Eyedropper tool
Sample style and append appearance of currently selected item	Alt + Shift-click + Eyedropper tool	Option + Shift-click + Eyedropper tool
Add new fill	Ctrl + / (forward slash)	Command + / (forward slash)

Result	Windows	Mac OS
Add new stroke	Ctrl + Alt + / (forward slash)	Command + Option + / (forward slash)
Reset gradient to black and white	Ctrl-click gradient button in Tools panel or Gradient panel	Command-click gradient button in Tools panel or Gradient panel
Open Mosaic options for selected raster object	Alt + o + j	
Decrease Bristle brush size	[[
Increase Bristle brush size]]
Set Bristle brush paint opacity value	Number keys 1 - 0. Number key 1 increases the value to 10% Number key 0 increases the value to 100%	Number keys 1 - 0. Number key 1 increases the value to 10% Number key 0 increases the value to 100%

Keys for working with Live Paint groups

This is not a complete list of keyboard shortcuts. This table lists only those shortcuts that are not displayed in menu commands or tool tips.

Result	Windows	Mac OS
Switch to Eyedropper tool and sample fill and/or stroke	Alt-click + Live Paint Bucket tool	Option-click + Live Paint Bucket tool
Switch to Eyedropper tool and sample color from an image or intermediate color from a gradient	Alt + Shift-click + Live Paint Bucket tool	Option + Shift-click + Live Paint Bucket tool
Select opposite Live Paint Bucket tool options (if Paint Fills and Paint Strokes are currently selected, switch to Paint Fills only)	Shift + Live Paint Bucket tool	Shift + Live Paint Bucket tool
Fill across unstroked edges into adjacent faces	Double-click + Live Paint Bucket tool	Double-click + Live Paint Bucket tool
Fill all faces that have same fill and stroke all edges that have same stroke	Triple-click + Live Paint Bucket tool	Triple-click + Live Paint Bucket tool
Switch to Eyedropper tool and sample fill and/or stroke	Alt-click + Live Paint Selection tool	Option-click + Live Paint Selection tool
Switch to Eyedropper tool and sample color from an image or intermediate color from a gradient	Alt + Shift-click + Live Paint Selection tool	Option + Shift-click + Live Paint Selection tool
Add to/subtract from a selection	Shift-click + Live Paint Selection tool	Shift-click + Live Paint Selection tool
Select all connected faces /edges with same fill/stroke	Double-click + Live Paint Selection tool	Double-click + Live Paint Selection tool
Select all faces/edges with same fill/stroke	Triple-click + Live Paint Selection tool	Triple-click + Live Paint Selection tool

Keys for transforming objects

This is not a complete list of keyboard shortcuts. This table lists only those shortcuts that are not displayed in menu commands or tool tips.

Keyboard shortcuts

Result	Windows	Mac OS
Set origin point and open dialog box when using Rotate tool, Scale tool, Reflect tool, or Shear tool	Alt-click	Option-click
Duplicate and transform selection when using Selection tool, Scale tool, Reflect tool, or Shear tool	Alt-drag	Option-drag
Transform pattern (independent of object) when using Selection tool, Scale tool, Reflect tool, or Shear tool	Tilde (~)-drag	Tilde (~)-drag

Keys for creating variable width points

This is not a complete list of keyboard shortcuts. This table lists only those shortcuts that are not displayed in menu commands or tool tips.

Results	Windows	Mac OS
Select multiple width points	Shift+click	Shift+click
Create non-uniform widths	Alt+drag	Option+drag
Create a copy of the width point	Alt+drag the width point	Options+drag the width point
Change the position of multiple width points	Shift+drag	Shift+drag
Delete selected width point	Delete	Delete
Deselect a width point	Esc	Esc

Keys for working with type

This is not a complete list of keyboard shortcuts. This table lists only those shortcuts that are not displayed in menu commands or tool tips.

Result	Windows	Mac OS
Move one character right or left	Right Arrow or Left Arrow	Right Arrow or Left Arrow
Move up or down one line	Up Arrow or Down Arrow	Up Arrow or Down Arrow
Move one word right or left	Ctrl + Right Arrow or Left Arrow	Command + Right Arrow or Left Arrow
Move up or down one paragraph	Ctrl + Up Arrow or Down Arrow	Command + Up Arrow or Down Arrow
Select one word right or left	Shift + Ctrl + Right Arrow or Left Arrow	Shift + Command + Right Arrow or Left Arrow
Select one paragraph before or after	Shift + Ctrl + Up Arrow or Down Arrow	Shift + Command + Up Arrow or Down Arrow
Extend existing selection	Shift-click	Shift-click
Align paragraph left, right, or center	Ctrl + Shift + L, R, or C	Command + Shift + L, R, or C
Justify paragraph	Ctrl + Shift + J	Command + Shift + J
Insert soft return	Shift + Enter	Shift + Return
Highlight kerning	Ctrl + Alt + K	Command + Option + K
Reset horizontal scale to 100%	Ctrl + Shift + X	Command + Shift + X

Result	Windows	Mac OS
Increase or decrease type size	Ctrl + Shift + > or <	Command + Shift + > or <
Increase or decrease leading	Alt + Up or Down Arrow (horizontal text) or Right or Left Arrow (vertical text)	Option + Up or Down Arrow (horizontal text) or Right or Left Arrow (vertical text)
Set leading to the type size	Double-click leading icon in the Character panel	Double-click leading icon in the Character panel
Reset tracking/kerning to 0	Ctrl + Alt + Q	Command + Option + Q
Increase or decrease kerning and tracking	Alt + Right or Left Arrow (horizontal text) or Up or Down Arrow (vertical text)	Option + Right or Left Arrow (horizontal text) or Up or Down Arrow (vertical text)
Increase or decrease kerning and tracking by five times	Ctrl + Alt + Right or Left Arrow (horizontal text) or Up or Down Arrow (vertical text)	Command + Option + Right or Left Arrow (horizontal text) or Up or Down Arrow (vertical text)
Increase or decrease baseline shift	Alt + Shift + Up or Down Arrow (horizontal text) or Right or Left Arrow (vertical text)	Option + Shift + Up or Down Arrow (horizontal text) or Right or Left Arrow (vertical text)
Switch between Type and Vertical Type, Area Type and Vertical Area Type, and Path Type and Vertical Path Type tools	Shift	Shift
Switch between Area Type and Path Type, Vertical Area Type and Vertical Path Type tools	Alt	Option

 To change the increment value for type shortcuts, choose *Edit > Preferences > Type (Windows) or Illustrator > Preferences > Type (Mac OS)*. Enter the values you want in the *Size/Leading, Baseline Shift, and Tracking* text boxes, and click *OK*.

Keys for using panels

This is not a complete list of keyboard shortcuts. This table lists only those shortcuts that are not displayed in menu commands or tool tips.

Result	Windows	Mac OS
Set options (except for Actions, Brushes, Swatches, and Symbols panels)	Alt-click New button	Option-click New button
Delete without confirmation (except for Layers panel)	Alt-click Delete button	Option-click Delete button
Apply value and keep text box active	Shift + Enter	Shift + Return
Select range of actions, brushes, layers, links, styles, or swatches	Shift-click	Shift-click
Select noncontiguous actions, brushes, layers (same level only), links, styles, or swatches	Ctrl-click	Command-click
Show/Hide all panels	Tab	Tab
Show/Hide all panels except the Tools panel and Control panel	Shift + Tab	Shift + Tab

Keys for the Actions panel

This is not a complete list of keyboard shortcuts. This table lists only those shortcuts that are not displayed in menu commands or tool tips.

Result	Windows	Mac OS
Expand/Collapse entire hierarchy for action set	Alt-click expansion triangle	Option-click expansion triangle
Set options for action set	Double-click folder icon	Double-click folder icon
Play a single command	Ctrl-click Play Current Selection button	Command-click Play Current Selection button
Begin recording actions without confirmation	Alt-click New Action button	Option-click New Action button

Keys for the Brushes panel

This is not a complete list of keyboard shortcuts. This table lists only those shortcuts that are not displayed in menu commands or tool tips.

Result	Windows	Mac OS
Open Brush Options dialog box	Double-click brush	Double-click brush
Duplicate brush	Drag brush to New Brush button	Drag brush to New Brush button

Keys for the Character and Paragraph panels

This is not a complete list of keyboard shortcuts. This table lists only those shortcuts that are not displayed in menu commands or tool tips.

Result	Windows	Mac OS
Increase/decrease the selected value by a small increment	Up Arrow or Down Arrow	Up Arrow or Down Arrow
Increase/decreases the selected value by a large increment	Shift + Up Arrow or Down Arrow	Shift + Up Arrow or Down Arrow
Highlight the font name field in the Character panel	Ctrl + Alt + Shift + F	Command + Option + Shift + F

Keys for the Color panel

This is not a complete list of keyboard shortcuts. This table lists only those shortcuts that are not displayed in menu commands or tool tips.

Result	Windows	Mac OS
Select the complement for the current color fill/stroke	Ctrl-click color bar	Command-click color bar
Change the nonactive fill/stroke	Alt-click color bar	Option-click color bar
Select the complement for the nonactive fill/stroke	Ctrl + Alt-click color bar	Command + Option-click color bar
Select the inverse for the current fill/stroke	Ctrl + Shift-click color bar	Command + Shift-click color bar

Result	Windows	Mac OS
Select the inverse for the nonactive fill/stroke	Ctrl + Shift + Alt-click color bar	Command + Shift + Option-click color bar
Change the color mode	Shift-click color bar	Shift-click color bar
Move color sliders in tandem	Shift-drag color slider	Shift-drag color slider
Switch between percentage and 0-255 values for RGB	Double-click to right of a numerical field	Double-click to right of a numerical field

Keys for the Gradient panel

This is not a complete list of keyboard shortcuts. This table lists only those shortcuts that are not displayed in menu commands or tool tips.

Result	Windows	Mac OS
Duplicate color stops	Alt-drag	Option-drag
Swap color stops	Alt-drag color stop onto another stop	Option-drag color stop onto another color stop
Apply swatch color to active (or selected) color stop	Alt-click swatch in the Swatches panel	Option-click swatch in the Swatches panel
Reset the gradient fill to default black and white linear gradient	Ctrl-click Gradient Fill box in the Gradient panel	Command-click Gradient Fill box in the Gradient panel
Show/Hide gradient arrow	Ctrl + Alt + G	Command + Option + G
Modify angle and end-point together	Alt-drag end point of gradient annotator	Option-drag end point of gradient annotator
Constrain Gradient tool or Gradient annotator while dragging	Shift-drag	Shift-drag
View Gradient annotator in selected gradient filled object	G	G

Keys for the Layers panel

This is not a complete list of keyboard shortcuts. This table lists only those shortcuts that are not displayed in menu commands or tool tips.

Result	Windows	Mac OS
Select all objects on the layer	Alt-click layer name	Option-click layer name
Show/hide all layers but the selected one	Alt-click eye icon	Option-click eye icon
Select Outline/Preview view for the selected layer	Ctrl-click eye icon	Command-click eye icon
Selects Outline/Preview view for all other layers	Ctrl + Alt-click eye icon	Command + Option-click eye icon
Lock/unlock all other layers	Alt-click lock icon	Option-click lock icon
Expand all sublayers to display entire hierarchy	Alt-click expansion triangle	Option-click expansion triangle
Set options as you create new layer	Alt-click New Layer button	Option-click New Layer button

Result	Windows	Mac OS
Set options as you create new sublayer	Alt-click New Sublayer button	Option-click New Sublayer button
Place new sublayer at bottom of layer list	Ctrl + Alt-click New Sublayer button	Command + Option-click New Sublayer button
Place layer at top of layer list	Ctrl-click New Layer button	Command-click New Layer button
Place layer below selected layer	Ctrl + Alt-click New Layer button	Command + Option-click New Layer button
Copy the selection to a layer, sublayer, or group	Alt-drag selection	Option-drag selection

Keys for the Swatches panel

This is not a complete list of keyboard shortcuts. This table lists only those shortcuts that are not displayed in menu commands or tool tips.

Result	Windows	Mac OS
Create new spot color	Ctrl-click New Swatch button	Command-click New Swatch button
Create new global process color	Ctrl + Shift-click New Swatch button	Command + Shift-click New Swatch button
Replace swatch with another	Alt-drag a swatch over another	Option-drag a swatch over another

Keys for the Transform panel

This is not a complete list of keyboard shortcuts. This table lists only those shortcuts that are not displayed in menu commands or tool tips.

Result	Windows	Mac OS
Apply a value and keep focus in edit field	Shift + Enter	Shift + Return
Apply a value and copy object	Alt + Enter	Option + Return
Apply a value and scale option proportionately for width or height	Ctrl + Enter	Command + Return

Keys for the Transparency panel

This is not a complete list of keyboard shortcuts. This table lists only those shortcuts that are not displayed in menu commands or tool tips.

Result	Windows	Mac OS
Change mask to grayscale image for editing	Alt-click on mask thumbnail	Option-click on mask thumbnail
Disable opacity mask	Shift-click on mask thumbnail	Shift-click on mask thumbnail
Re-enable opacity mask	Shift-click on disabled mask thumbnail	Shift-click on disabled mask thumbnail
Increase/decrease opacity in 1% increments	Click opacity field + Up Arrow or Down Arrow	Click opacity field + Up Arrow or Down Arrow
Increase/decrease opacity in 10% increments	Shift-click opacity field + Up Arrow or Down Arrow	Shift-click opacity field + Up Arrow or Down Arrow

Function keys

This is not a complete list of keyboard shortcuts. This table lists only those shortcuts that are not displayed in menu commands or tool tips.

Result	Windows	Mac OS
Invoke Help	F1	F1
Cut	F2	F2
Copy	F3	F3
Paste	F4	F4
Show/hide Brushes panel	F5	F5
Show/hide Color panel	F6	F6
Show/hide Layers panel	F7	F7
Create new symbol	F8	F8
Show/hide Info panel	Ctrl + F8	Command + F8
Show/hide Gradient panel	Ctrl + F9	Command + F9
Show/hide Stroke panel	Ctrl + F10	Command + F10
Show/hide Attributes panel	Ctrl + F11	Command + F11
Revert	F12	F12
Show/hide Graphic Styles panel	Shift + F5	Shift + F5
Show/hide Appearance panel	Shift + F6	Shift + F6
Show/hide Align panel	Shift + F7	Shift + F7
Show/hide Transform panel	Shift + F8	Shift + F8
Show/hide Pathfinder panel	Shift + Ctrl + F9	Shift + Command + F9
Show/hide Transparency panel	Shift + Ctrl + F10	Shift + Command + F10
Show/hide Symbols panel	Shift + Ctrl + F11	Shift + Command + F11
Show/hide perspective grid	Ctrl+Shift+I	Command+Shift+I